

TOSHIBA GTR MODULE SILICON N CHANNEL IGBT

MG600Q1US41

HIGH POWER SWITCHING APPLICATIONS.

MOTOR CONTROL APPLICATIONS.

- High Input Impedance
- High Speed : $t_f = 0.5\mu s$ (Max.)
- Low Saturation Voltage : $V_{CE(sat)} = 4.0V$ (Max.)
- Enhancement-Mode
- Outline : TOSHIBA 2-109E1A
(See page 3 for the device outline)
- Weight : 590g (TYP.)

EQUIVALENT CIRCUIT

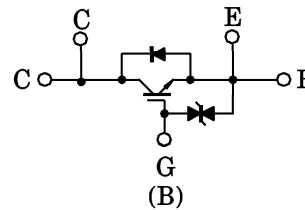

MAXIMUM RATINGS (Ta = 25°C)

CHARACTERISTIC		SYMBOL	RATING	UNIT
Collector-Emitter Voltage		V_{CES}	1200	V
Gate-Emitter Voltage		V_{GES}	±20	V
Collector Current	DC	I_C	600	A
	1ms	I_{CP}	1200	
Forward Current	DC	I_F	600	A
	1ms	I_{FM}	1200	
Collector Power Dissipation (Tc = 25°C)		P_C	3600	W
Junction Temperature		T_j	150	°C
Storage Temperature Range		T_{stg}	-40~125	°C
Isolation Voltage		V_{Isol}	2500 (AC 1 minute)	V
Screw Torque (Terminal : M4 / M6 / Mounting)		—	2 / 3 / 3	N·m

961001EAA2

● TOSHIBA is continually working to improve the quality and the reliability of its products. Nevertheless, semiconductor devices in general can malfunction or fail due to their inherent electrical sensitivity and vulnerability to physical stress. It is the responsibility of the buyer, when utilizing TOSHIBA products, to observe standards of safety, and to avoid situations in which a malfunction or failure of a TOSHIBA product could cause loss of human life, bodily injury or damage to property. In developing your designs, please ensure that TOSHIBA products are used within specified operating ranges as set forth in the most recent products specifications. Also, please keep in mind the precautions and conditions set forth in the TOSHIBA Semiconductor Reliability Handbook.

● The information contained herein is presented only as a guide for the applications of our products. No responsibility is assumed by TOSHIBA CORPORATION for any infringements of intellectual property or other rights of the third parties which may result from its use. No license is granted by implication or otherwise under any intellectual property or other rights of TOSHIBA CORPORATION or others.

● The information contained herein is subject to change without notice.

ELECTRICAL CHARACTERISTICS (Ta = 25°C)

CHARACTERISTIC		SYMBOL	TEST CONDITION	MIN.	TYP.	MAX.	UNIT
Gate Leakage Current		I_{GES}	$V_{GE} = \pm 20V, V_{CE} = 0$	—	—	± 60	μA
Collector Cut-off Current		I_{CES}	$V_{CE} = 1200V, V_{GE} = 0$	—	—	6.0	mA
Gate-Emitter Cut-off Voltage		$V_{GE(OFF)}$	$I_C = 600mA, V_{CE} = 5V$	3.0	—	8.0	V
Collector-Emitter Saturation Voltage		$V_{CE(sat)}$	$I_C = 600A, V_{GE} = 15V$	—	3.0	4.0	V
Input Capacitance		C_{ies}	$V_{CE} = 10V, V_{GE} = 0, f = 1MHz$	—	72000	—	pF
Switching Time	Rise Time	t_r		—	0.3	0.6	μs
	Turn-on Time	t_{on}		—	0.4	0.8	
	Fall Time	t_f		—	0.2	0.5	
	Turn-off Time	t_{off}		—	0.8	1.5	
Forward Voltage		V_F	$I_F = 600A, V_{GE} = 0$	—	2.3	3.2	V
Reverse Recovery Time		t_{rr}	$I_F = 600A, V_{GE} = -10V$ $di/dt = 1000A/\mu s$	—	0.25	—	μs
Thermal Resistance		$R_{th(j-c)}$	Transistor	—	—	0.035	$^{\circ}C/W$
			Diode	—	—	0.125	

OUTLINE : TOSHIBA 2-109E1A

Unit in mm

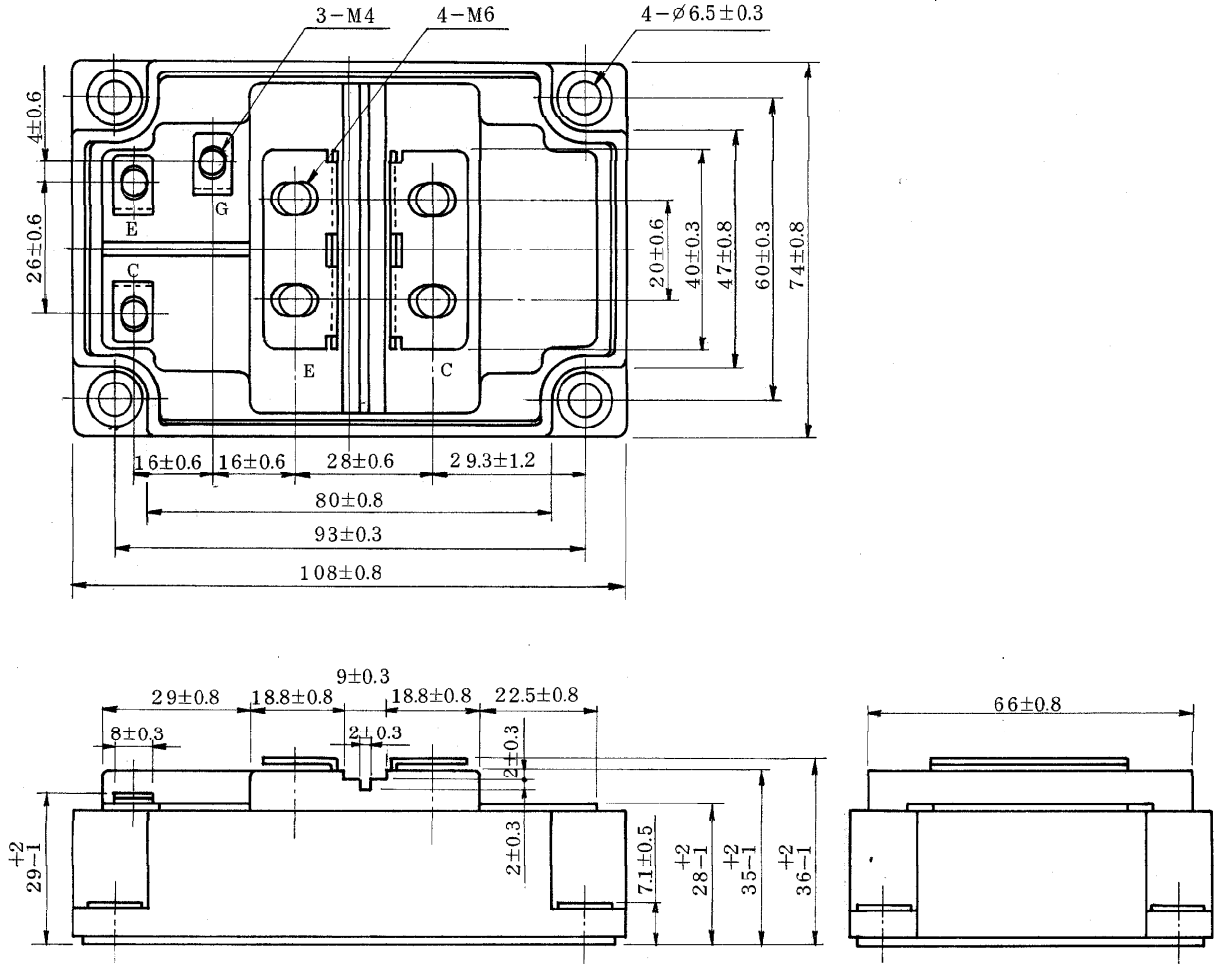

Weight : 590g (TYP.)

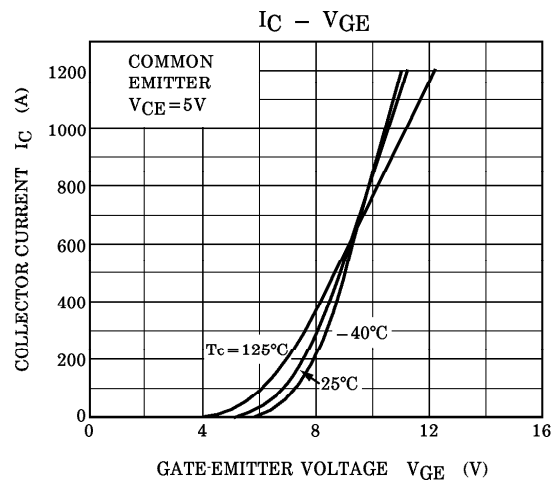
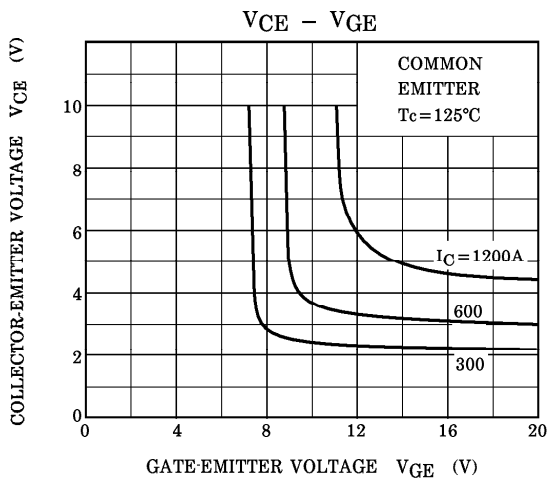
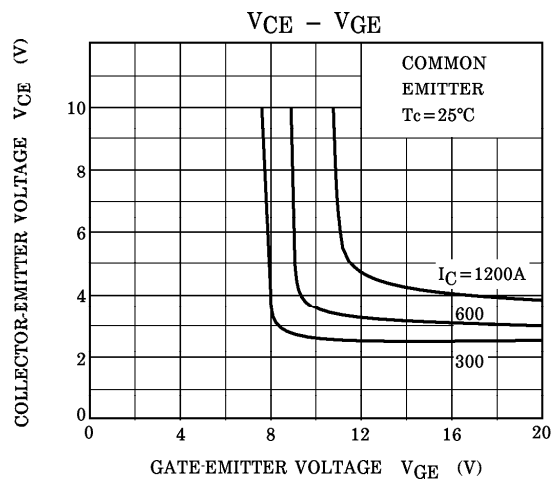
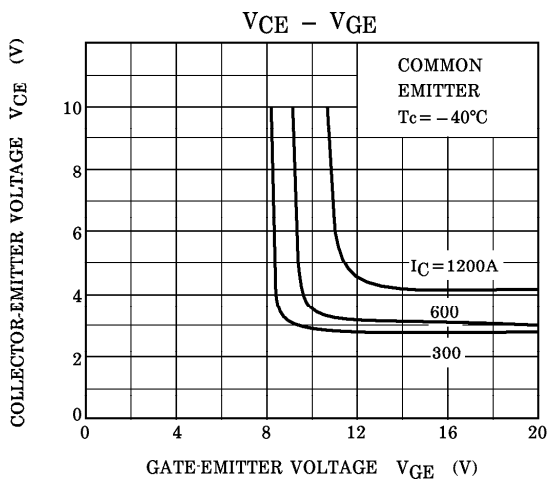
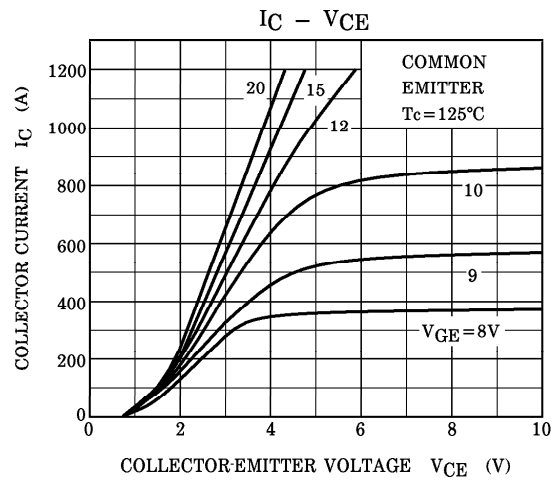
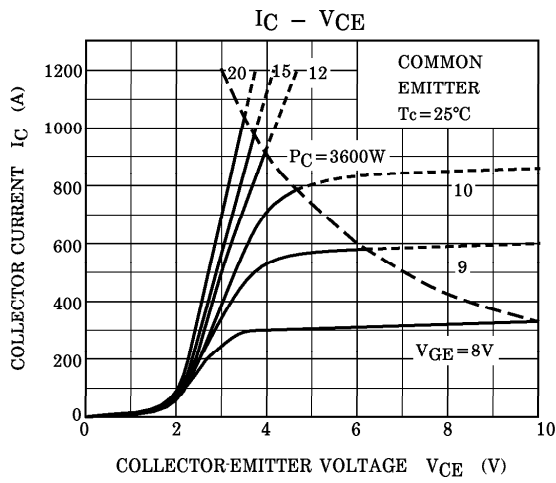

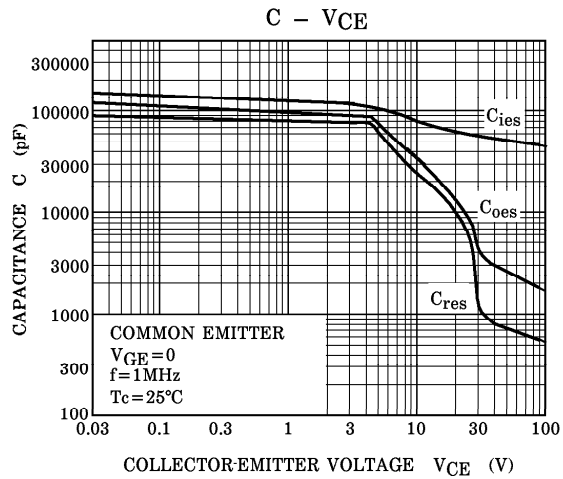
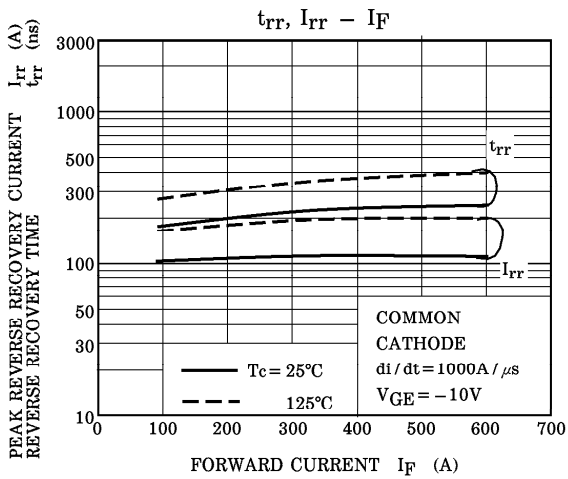
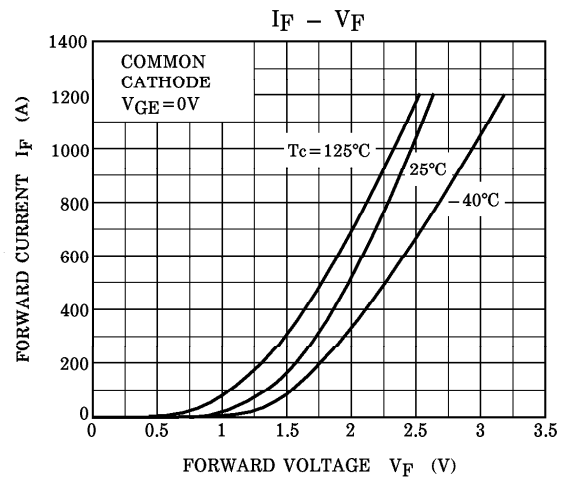
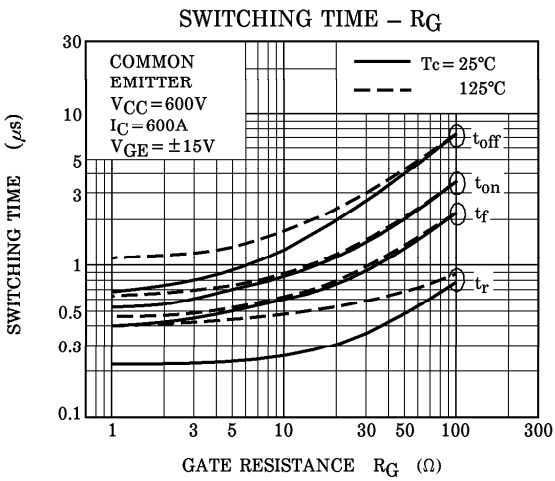
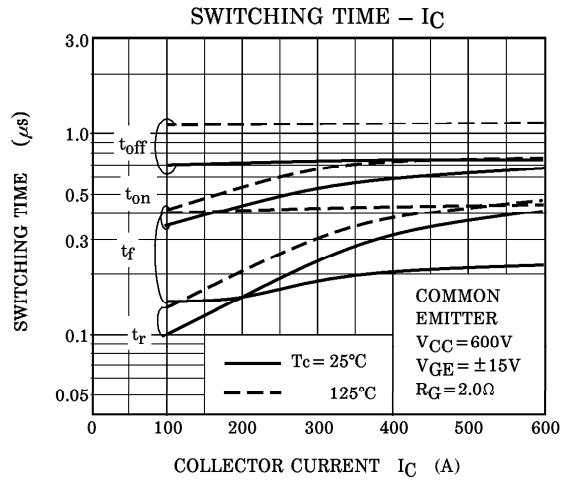
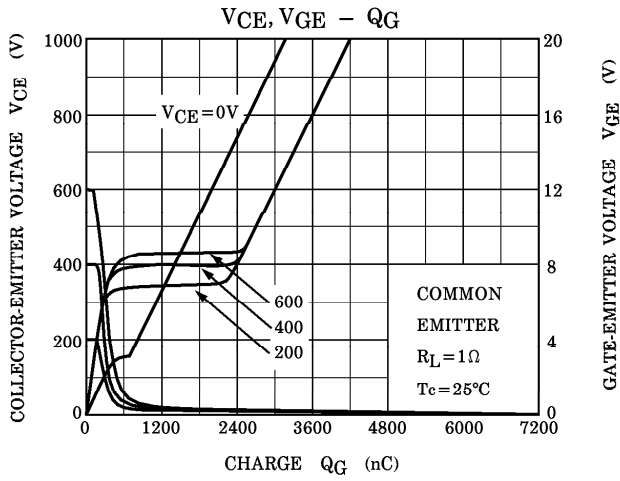

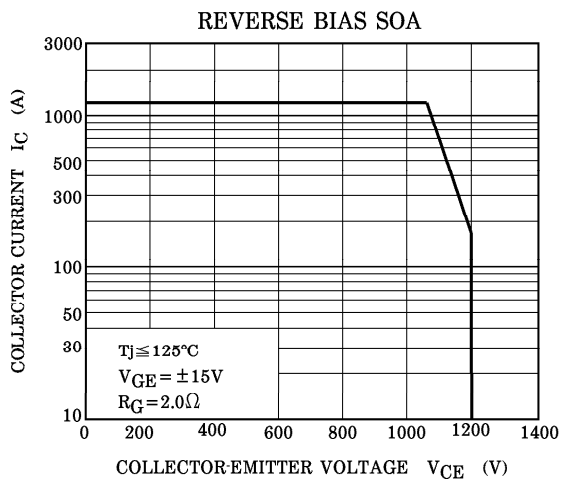
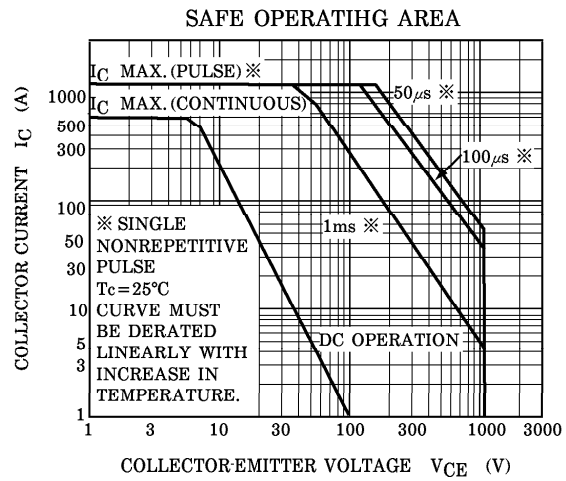
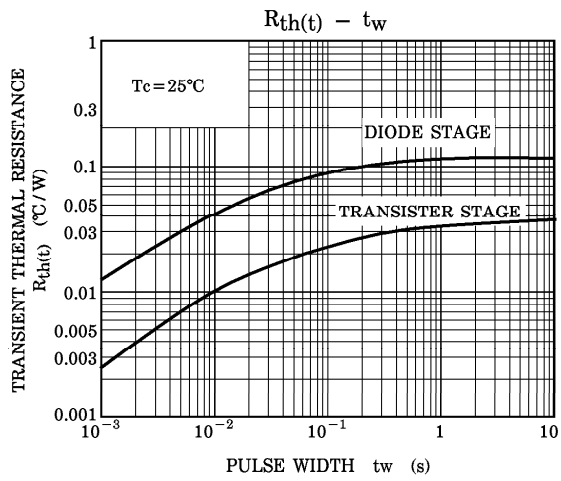

This datasheet has been downloaded from:

www.DatasheetCatalog.com

Datasheets for electronic components.