

SKiIP 23NAB12T4V1



MiniSKiIP® 2

SKiIP 23NAB12T4V1

Features

- Trench 4 IGBT's
- Robust and soft freewheeling diodes in CAL technology
- Highly reliable spring contacts for electrical connections
- UL recognised file no. E63532

Typical Applications*

- Inverter up to 14 kVA
- Typical motor power 7,5 kW

Remarks

- V_{CEsat} , V_F = chip level value
- Case temp. limited to $T_C = 125^\circ\text{C}$ max. (for baseplateless modules $T_C = T_S$)
- product rel. results valid for $T_j \leq 150$ (recomm. Top = $-40 \dots +150^\circ\text{C}$)

Absolute Maximum Ratings			
Symbol	Conditions	Values	Unit
Inverter - IGBT			
V_{CES}	$T_j = 25^\circ\text{C}$	1200	V
I_C	$T_j = 150^\circ\text{C}$	$T_s = 25^\circ\text{C}$	33
		$T_s = 70^\circ\text{C}$	26
I_C	$T_j = 175^\circ\text{C}$	$T_s = 25^\circ\text{C}$	37
		$T_s = 70^\circ\text{C}$	30
I_{Cnom}		25	A
I_{CRM}	$I_{CRM} = 3 \times I_{Cnom}$	75	A
V_{GES}		-20 ... 20	V
t_{psc}	$V_{CC} = 800\text{ V}$ $V_{GE} \leq 15\text{ V}$ $V_{CES} \leq 1200\text{ V}$	$T_j = 150^\circ\text{C}$	10
T_j		-40 ... 175	$^\circ\text{C}$
Chopper - IGBT			
V_{CES}	$T_j = 25^\circ\text{C}$	1200	V
I_C	$T_j = 150^\circ\text{C}$	$T_s = 25^\circ\text{C}$	33
		$T_s = 70^\circ\text{C}$	26
I_C	$T_j = 175^\circ\text{C}$	$T_s = 25^\circ\text{C}$	37
		$T_s = 70^\circ\text{C}$	30
I_{Cnom}		25	A
I_{CRM}	$I_{CRM} = 3 \times I_{Cnom}$	75	A
V_{GES}		-20 ... 20	V
t_{psc}	$V_{CC} = 800\text{ V}$ $V_{GE} \leq 15\text{ V}$ $V_{CES} \leq 1200\text{ V}$	$T_j = 150^\circ\text{C}$	10
T_j		-40 ... 175	$^\circ\text{C}$
Inverse - Diode			
V_{RRM}	$T_j = 25^\circ\text{C}$	1200	V
I_F	$T_j = 150^\circ\text{C}$	$T_s = 25^\circ\text{C}$	29
		$T_s = 70^\circ\text{C}$	22
I_F	$T_j = 175^\circ\text{C}$	$T_s = 25^\circ\text{C}$	32
		$T_s = 70^\circ\text{C}$	26
I_{Fnom}		25	A
I_{FRM}	$I_{FRM} = 3 \times I_{Fnom}$	75	A
I_{FSM}	$t_p = 10\text{ ms, sin } 180^\circ, T_j = 150^\circ\text{C}$	100	A
T_j		-40 ... 175	$^\circ\text{C}$
Freewheeling - Diode			
V_{RRM}	$T_j = 25^\circ\text{C}$	1200	V
I_F	$T_j = 150^\circ\text{C}$	$T_s = 25^\circ\text{C}$	29
		$T_s = 70^\circ\text{C}$	22
I_F	$T_j = 175^\circ\text{C}$	$T_s = 25^\circ\text{C}$	32
		$T_s = 70^\circ\text{C}$	26
I_{Fnom}		25	A
I_{FRM}	$I_{FRM} = 3 \times I_{Fnom}$	75	A
I_{FSM}	$t_p = 10\text{ ms, sin } 180^\circ, T_j = 150^\circ\text{C}$	100	A
T_j		-40 ... 175	$^\circ\text{C}$

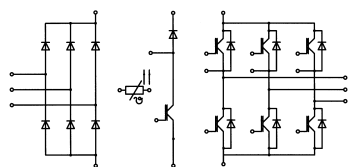

NAB

SKiIP 23NAB12T4V1



MiniSKiIP® 2

SKiIP 23NAB12T4V1

Features

- Trench 4 IGBT's
- Robust and soft freewheeling diodes in CAL technology
- Highly reliable spring contacts for electrical connections
- UL recognised file no. E63532

Typical Applications*

- Inverter up to 14 kVA
- Typical motor power 7,5 kW

Remarks

- V_{CEsat} , V_F = chip level value
- Case temp. limited to $T_C = 125^\circ\text{C}$ max. (for baseplateless modules $T_C = T_S$)
- product rel. results valid for $T_j \leq 150$ (recomm. Top = $-40 \dots +150^\circ\text{C}$)

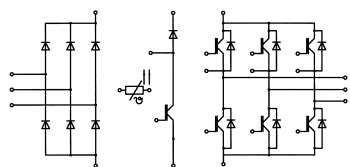

NAB

Absolute Maximum Ratings			
Symbol	Conditions	Values	Unit
Rectifier - Diode			
V_{RRM}	$T_j = 25^\circ\text{C}$	1600	V
I_F	$T_s = 25^\circ\text{C}, T_j = 150^\circ\text{C}$	52	A
I_{Fnom}		13	A
I_{FSM}	10 ms	$T_j = 25^\circ\text{C}$	370
	sin 180°	$T_j = 150^\circ\text{C}$	270
I^2t	10 ms	$T_j = 25^\circ\text{C}$	685
	sin 180°	$T_j = 150^\circ\text{C}$	365
T_j		-40 ... 150	$^\circ\text{C}$
Module			
$I_t(\text{RMS})$	$T_{\text{terminal}} = 80^\circ\text{C}, 20\text{A per spring}$	40	A
T_{stg}		-40 ... 125	$^\circ\text{C}$
V_{isol}	AC sinus 50Hz, 1 min	2500	V

Characteristics					
Symbol	Conditions	min.	typ.	max.	Unit
Inverter - IGBT					
$V_{CE(\text{sat})}$	$I_C = 25\text{ A}$ $V_{GE} = 15\text{ V}$ chipelevel	$T_j = 25^\circ\text{C}$	1.85	2.10	V
		$T_j = 150^\circ\text{C}$	2.25	2.45	V
V_{CE0}		$T_j = 25^\circ\text{C}$	0.8	0.9	V
		$T_j = 150^\circ\text{C}$	0.7	0.8	V
r_{CE}	$V_{GE} = 15\text{ V}$	$T_j = 25^\circ\text{C}$	42	48	m Ω
		$T_j = 150^\circ\text{C}$	62	66	m Ω
$V_{GE(\text{th})}$	$V_{GE} = V_{CE}\text{ V}, I_C = 1\text{ mA}$	5	5.8	6.5	V
I_{CES}	$V_{GE} = 0\text{ V}$ $V_{CE} = 1200\text{ V}$	$T_j = 25^\circ\text{C}$	0.1	0.3	mA
					mA
C_{ies}	$V_{CE} = 25\text{ V}$ $V_{GE} = 0\text{ V}$	$f = 1\text{ MHz}$	1.43		nF
C_{oes}		$f = 1\text{ MHz}$	0.12		nF
C_{res}		$f = 1\text{ MHz}$	0.09		nF
Q_G	- 8 V...+ 15 V		142		nC
R_{Gint}	$T_j = 25^\circ\text{C}$		0.00		Ω
$t_{d(\text{on})}$	$V_{CC} = 600\text{ V}$	$T_j = 150^\circ\text{C}$	28		ns
t_r	$I_C = 25\text{ A}$	$T_j = 150^\circ\text{C}$	40		ns
E_{on}	$R_{G\text{ on}} = 24\ \Omega$	$T_j = 150^\circ\text{C}$	2.65		mJ
$t_{d(\text{off})}$	$R_{G\text{ off}} = 24\ \Omega$	$T_j = 150^\circ\text{C}$	295		ns
t_f		$T_j = 150^\circ\text{C}$	68		ns
E_{off}	$V_{GE} = +15/-15\text{ V}$	$T_j = 150^\circ\text{C}$	2.3		mJ
$R_{th(j-s)}$	per IGBT		1.2		K/W
Chopper - IGBT					
$V_{CE(\text{sat})}$	$I_C = 25\text{ A}$ $V_{GE} = 15\text{ V}$ chipelevel	$T_j = 25^\circ\text{C}$	1.85	2.10	V
		$T_j = 150^\circ\text{C}$	2.25	2.45	V
V_{CE0}		$T_j = 25^\circ\text{C}$	0.8	0.9	V
		$T_j = 150^\circ\text{C}$	0.7	0.8	V
r_{CE}	$V_{GE} = 15\text{ V}$	$T_j = 25^\circ\text{C}$	42	48	m Ω
		$T_j = 150^\circ\text{C}$	62	66	m Ω
$V_{GE(\text{th})}$	$V_{GE} = V_{CE}\text{ V}, I_C = 1\text{ mA}$	5	5.8	6.5	V
I_{CES}	$V_{GE} = 0\text{ V}$ $V_{CE} = 1200\text{ V}$	$T_j = 25^\circ\text{C}$	0.1	0.3	mA
		$T_j = 150^\circ\text{C}$			mA
Q_G	- 8 V...+ 15 V		142		nC
R_{Gint}	$T_j = 25^\circ\text{C}$		0.00		Ω

SKiIP 23NAB12T4V1

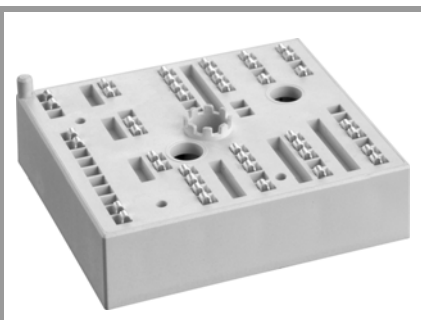

MiniSKiIP® 2

SKiIP 23NAB12T4V1

Features

- Trench 4 IGBT's
- Robust and soft freewheeling diodes in CAL technology
- Highly reliable spring contacts for electrical connections
- UL recognised file no. E63532

Typical Applications*

- Inverter up to 14 kVA
- Typical motor power 7,5 kW

Remarks

- V_{CEsat} , V_{F} = chip level value
- Case temp. limited to $T_C = 125^\circ\text{C}$ max. (for baseplateless modules $T_C = T_S$)
- product rel. results valid for $T_j \leq 150$ (recomm. Top = $-40 \dots +150^\circ\text{C}$)

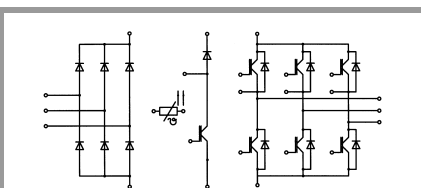

NAB

Characteristics					
Symbol	Conditions	min.	typ.	max.	Unit
Chopper - IGBT					
$t_{d(on)}$	$V_{CC} = 600\text{ V}$	$T_j = 150^\circ\text{C}$	28		ns
t_r	$I_C = 25\text{ A}$	$T_j = 150^\circ\text{C}$	40		ns
E_{on}	$R_{G\ on} = 24\ \Omega$	$T_j = 150^\circ\text{C}$	2.65		mJ
	$R_{G\ off} = 24\ \Omega$	$T_j = 150^\circ\text{C}$	295		ns
$t_{d(off)}$		$T_j = 150^\circ\text{C}$	68		ns
t_f		$T_j = 150^\circ\text{C}$	68		ns
E_{off}	$V_{GE} = +15/-15\text{ V}$	$T_j = 150^\circ\text{C}$	2.3		mJ
$R_{th(j-s)}$	per IGBT		1.2		K/W
Inverse - Diode					
$V_F = V_{EC}$	$I_F = 25\text{ A}$	$T_j = 25^\circ\text{C}$	2.40	2.7	V
	$V_{GE} = 0\text{ V}$ chiplevel	$T_j = 150^\circ\text{C}$	2.5	2.8	V
V_{F0}		$T_j = 25^\circ\text{C}$	1.3	1.5	V
		$T_j = 150^\circ\text{C}$	0.9	1.1	V
r_F		$T_j = 25^\circ\text{C}$	44	50	m Ω
		$T_j = 150^\circ\text{C}$	62	68	m Ω
I_{RRM}	$I_F = 25\text{ A}$	$T_j = 150^\circ\text{C}$	24		A
Q_{rr}	$di/dt_{off} = 850\text{ A}/\mu\text{s}$	$T_j = 150^\circ\text{C}$	3.7		μC
E_{rr}	$V_{GE} = -15\text{ V}$ $V_{CC} = 600\text{ V}$	$T_j = 150^\circ\text{C}$	1.6		mJ
$R_{th(j-s)}$	per Diode		1.52		K/W
Freewheeling - Diode					
$V_F = V_{EC}$	$I_F = 25\text{ A}$	$T_j = 25^\circ\text{C}$	2.4	2.7	V
	$V_{GE} = 0\text{ V}$ chiplevel	$T_j = 150^\circ\text{C}$	2.5	2.8	V
V_{F0}		$T_j = 25^\circ\text{C}$	1.3	1.5	V
		$T_j = 150^\circ\text{C}$	0.9	1.1	V
r_F		$T_j = 25^\circ\text{C}$	44	50	m Ω
		$T_j = 150^\circ\text{C}$	62	68	m Ω
I_{RRM}	$I_F = 25\text{ A}$	$T_j = 150^\circ\text{C}$	24		A
Q_{rr}	$di/dt_{off} = 850\text{ A}/\mu\text{s}$	$T_j = 150^\circ\text{C}$	3.7		μC
E_{rr}	$V_{GE} = -15\text{ V}$ $V_{CC} = 600\text{ V}$	$T_j = 150^\circ\text{C}$	1.6		mJ
$R_{th(j-s)}$	per Diode		1.52		K/W
Rectifier - Diode					
$V_F = V_{EC}$	$I_F = 13\text{ A}$	$T_j = 25^\circ\text{C}$	1	1.21	V
	$V_{GE} = 0\text{ V}$ chiplevel	$T_j = 125^\circ\text{C}$		1.1	V
V_{F0}		$T_j = 25^\circ\text{C}$		1.0	V
		$T_j = 125^\circ\text{C}$		0.8	V
r_F		$T_j = 25^\circ\text{C}$	9.2	18	m Ω
		$T_j = 125^\circ\text{C}$		21	m Ω
$R_{th(j-s)}$	per Diode		1.25		K/W
Module					
M_s	to heat sink		2	2.5	Nm
w			65		g
Temperatur Sensor					
R_{100}	$T_r = 100^\circ\text{C}$, tolerance = 3 %		1670 \pm 3%		Ω
$R(T)$	$R(T) = 1000\ \Omega [1 + A(T - 25^\circ\text{C}) + B(T - 25^\circ\text{C})^2]$ $A = 7.635 \cdot 10^{-3}\ \text{C}^{-1}$, $B = 1.731 \cdot 10^{-5}\ \text{C}^{-2}$				

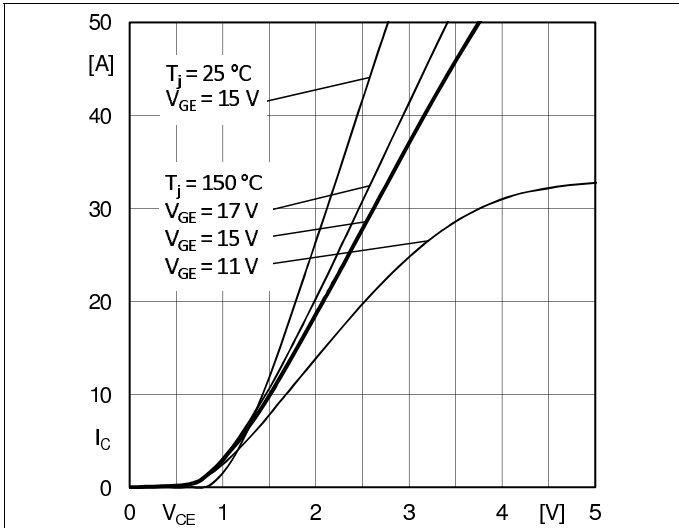

Fig. 1: Typ. output characteristic

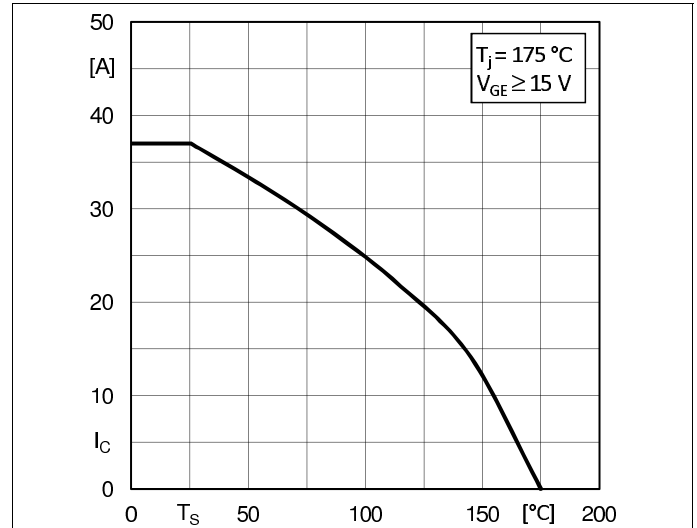

Fig. 2: Typ. rated current vs. temperature $I_C = f(T_s)$

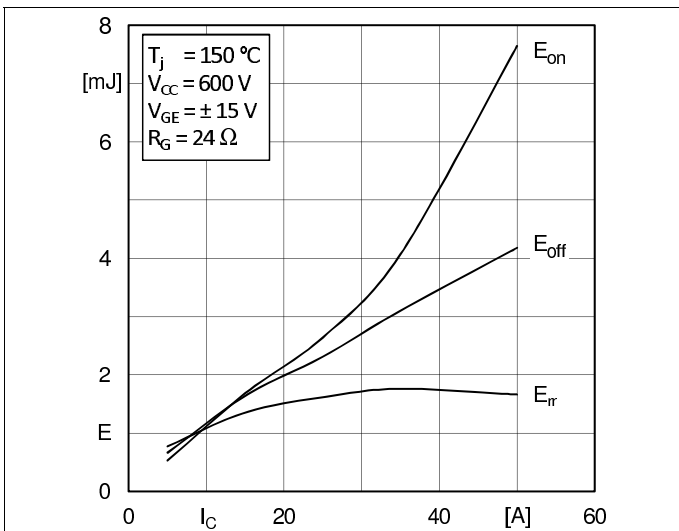

Fig. 3: Typ. turn-on /-off energy = $f(I_C)$

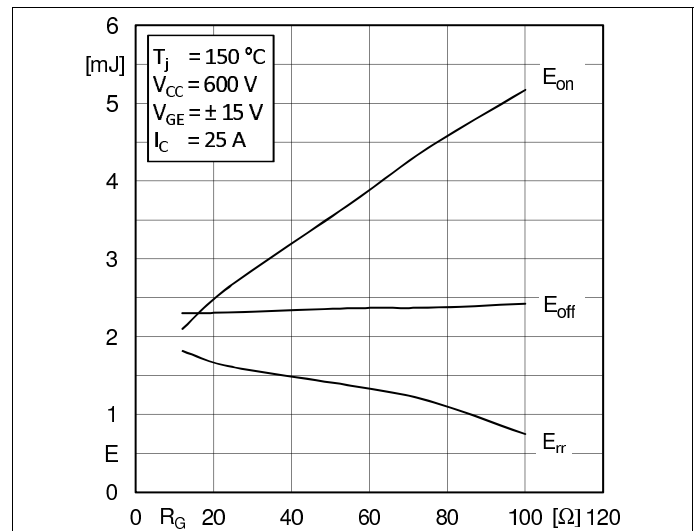

Fig. 4: Typ. turn-on /-off energy = $f(R_G)$

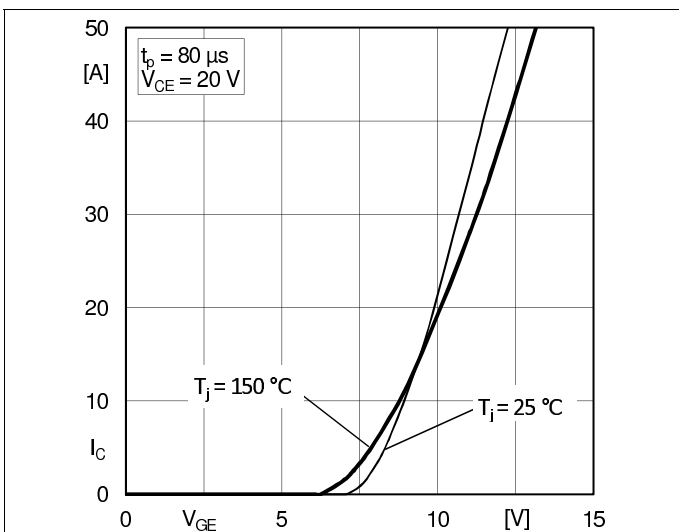

Fig. 5: Typ. transfer characteristic

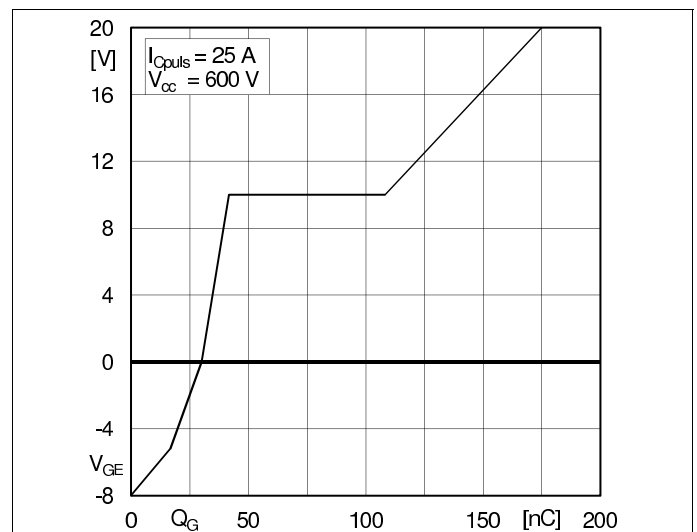

Fig. 6: Typ. gate charge characteristic

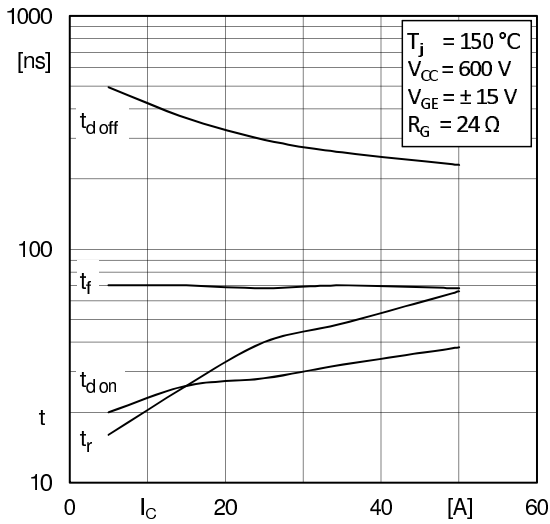

Fig. 7: Typ. switching times vs. I_C

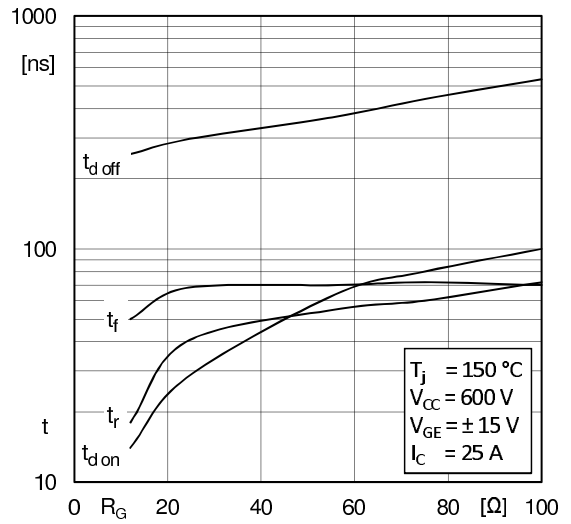

Fig. 8: Typ. switching times vs. gate resistor R_G

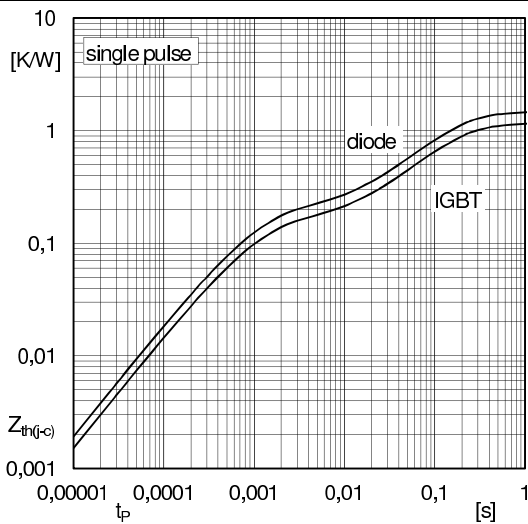

Fig. 9: Transient thermal impedance of IGBT and Diode

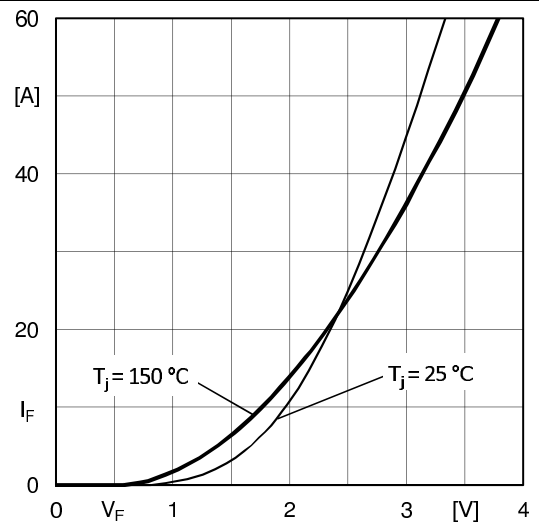

Fig. 10: CAL diode forward characteristic

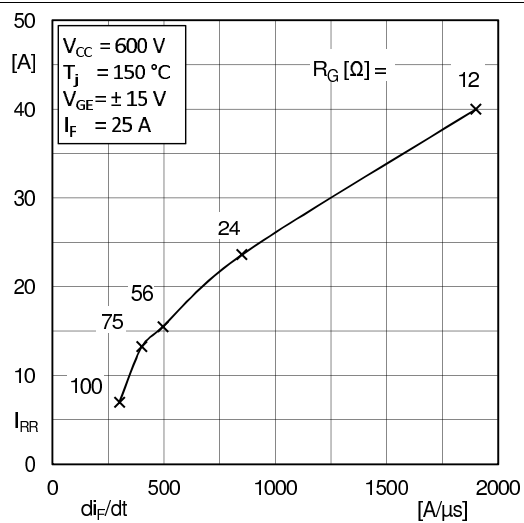

Fig. 11: Typ. CAL diode peak reverse recovery current

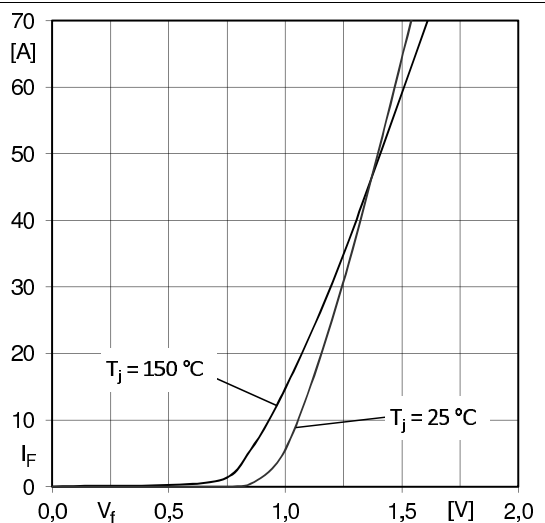
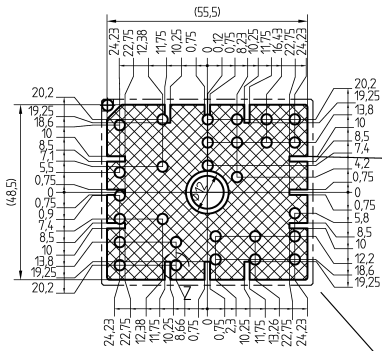

Fig. 12: Typ. input bridge forward characteristic

SKiiP 23NAB12T4V1

PCB
PCB TOP-VIEW



MiniSKiiP 2

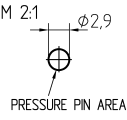
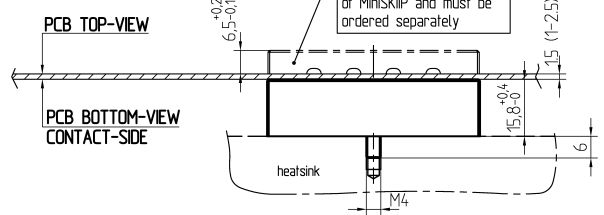

PCB BOTTOM-VIEW CONTACT-SIDE

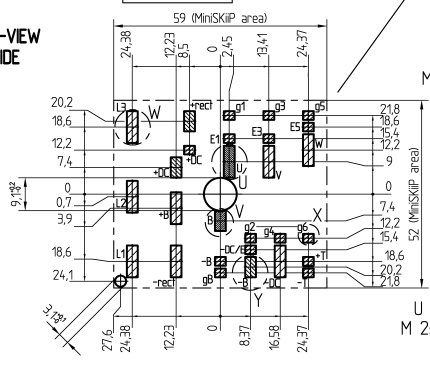

For mounting please follow the assembly instruction

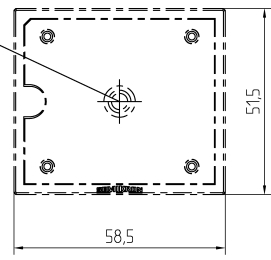

measure: mm
tolerance: ISO 2768-f

These documents are Semikron property. Semikron reserves all copyrights. All copying and transmitting of this information requires written permission. For the case of industrial property rights, Semikron reserves all rights.

pinout, dimensions

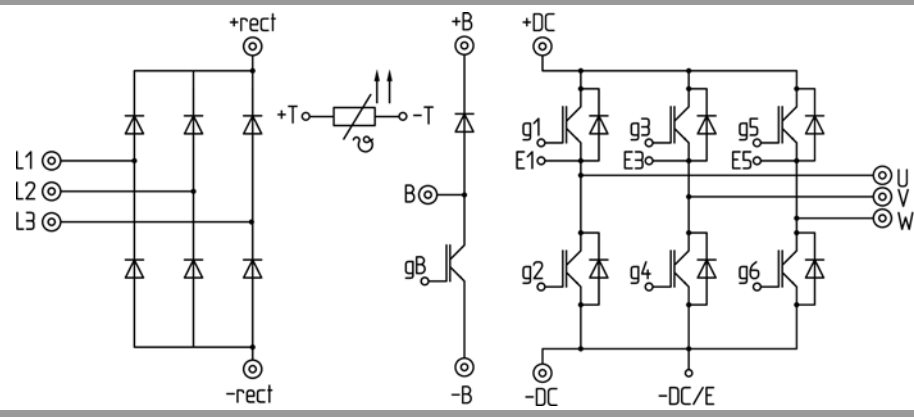

⊙ power connector
• control connector

pinout

This is an electrostatic discharge sensitive device (ESDS), international standard IEC 60747-1, Chapter IX

* The specifications of our components may not be considered as an assurance of component characteristics. Components have to be tested for the respective application. Adjustments may be necessary. The use of SEMIKRON products in life support appliances and systems is subject to prior specification and written approval by SEMIKRON. We therefore strongly recommend prior consultation of our staff.