

SEMITOP[®] 3

IGBT Module

SK50GH065F

Target Data

Features

- Compact design
- One screw mounting
- Heat transfer and isolation through direct copper bonding aluminium oxide ceramic (DBC)
- Ultrafast NPT IGBT
- Turbo FWDiodes
- Low threshold voltage
- Low tail current with low temperature dependence

Typical Applications*

- Switching (not for linear use)
- Inverter
- Switched mode power supplies
- UPS

Remarks

- V_F = chip level value

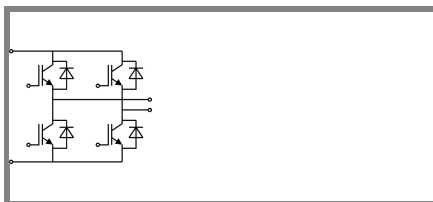

GH

Absolute Maximum Ratings		$T_s = 25\text{ °C}$, unless otherwise specified			
Symbol	Conditions	Values			Units
IGBT					
V_{CES}	$T_j = 25\text{ °C}$	600			V
I_C	$T_j = 125\text{ °C}$	$T_s = 25\text{ °C}$	54		A
		$T_s = 80\text{ °C}$	40		A
I_{CRM}	$I_{CRM} = 2 \times I_{Cnom}$	100			A
V_{GES}		± 20			V
t_{psc}	$V_{CC} = 300\text{ V}; V_{GE} \leq 20\text{ V}; T_j = 125\text{ °C}$ $V_{CES} < 600\text{ V}$	10			µs
Inverse Diode					
I_F	$T_j = 150\text{ °C}$	$T_s = 25\text{ °C}$	82		A
		$T_s = 80\text{ °C}$	50		A
I_{FRM}	$I_{FRM} = 2 \times I_{Fnom}$	120			A
Module					
$I_{t(RMS)}$					A
T_{vj}		-40 ... +150			°C
T_{stg}		-40 ... +125			°C
V_{isol}	AC, 1 min.	2500			V

Characteristics		$T_s = 25\text{ °C}$, unless otherwise specified			
Symbol	Conditions	min.	typ.	max.	Units
IGBT					
$V_{GE(th)}$	$V_{GE} = V_{CE}, I_C = 0,7\text{ mA}$	3	4	5	V
I_{CES}	$V_{GE} = 600\text{ V}, V_{CE} = V_{CES}, T_j = 25\text{ °C}$	0,0022			mA
I_{GES}	$V_{CE} = 0\text{ V}, V_{GE} = 20\text{ V}, T_j = 25\text{ °C}$	120			nA
V_{CE0}		$T_j = 25\text{ °C}$	1,2		V
		$T_j = 125\text{ °C}$	1,1		V
r_{CE}	$V_{GE} = 15\text{ V}$	$T_j = 25\text{ °C}$	12		mΩ
		$T_j = 125\text{ °C}$	22		mΩ
$V_{CE(sat)}$	$I_{Cnom} = 60\text{ A}, V_{GE} = 15\text{ V}$	$T_j = 25\text{ °C}_{chiplev.}$	2		V
		$T_j = 125\text{ °C}_{chiplev.}$	2,2		V
C_{res}	$V_{CE} = 25, V_{GE} = 0\text{ V}$	3,2			nF
C_{oes}		0,3			nF
C_{res}		0,18			nF
$t_{d(on)}$	$R_{Gon} = 15\text{ } \Omega$ $di/dt = 1200\text{ A}/\mu\text{s}$	$V_{CC} = 300\text{ V}$ $I_C = 60\text{ A}$			ns
t_r			1,07		ns
E_{on}	$R_{Goff} = 15\text{ } \Omega$ $di/dt = 1200\text{ A}/\mu\text{s}$	$T_j = 125\text{ °C}$ $V_{GE} = \pm 15\text{ V}$			mJ
$t_{d(off)}$					ns
t_f			1,76		ns
E_{off}					mJ
$R_{th(j-s)}$	per IGBT	0,85			K/W

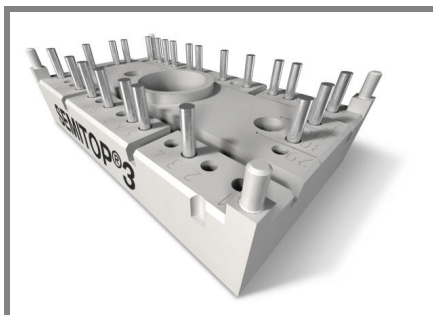

SEMITOP® 3

IGBT Module

SK50GH065F

Target Data

Features

- Compact design
- One screw mounting
- Heat transfer and isolation through direct copper bonding aluminium oxide ceramic (DBC)
- Ultrafast NPT IGBT
- Turbo FWDiodes
- Low threshold voltage
- Low tail current with low temperature dependence

Typical Applications*

- Switching (not for linear use)
- Inverter
- Switched mode power supplies
- UPS

Remarks

- V_F = chip level value

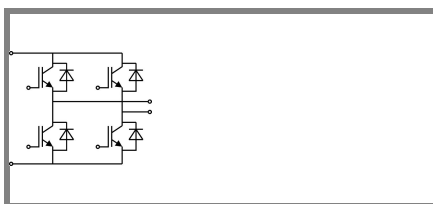

GH

Characteristics		min.	typ.	max.	Units
Symbol	Conditions				
Inverse Diode					
$V_F = V_{EC}$	$I_{Fnom} = 60 \text{ A}; V_{GE} = 0 \text{ V}$		1,1	1,6	V
				1,2	V
					V
V_{F0}			0,85		V
r_F			12		mΩ
I_{RRM}	$I_F = 40 \text{ A}$		40		A
Q_{rr}	$di/dt = 1200 \text{ A}/\mu\text{s}$		3		μC
E_{rr}	$V_{CC} = 300 \text{ V}$		0,42		mJ
$R_{th(j-s)D}$	per diode			1,1	K/W
M_s	to heat sink	2,25		2,5	Nm
w			30		g

This is an electrostatic discharge sensitive device (ESDS), international standard IEC 60747-1, Chapter IX.

* The specifications of our components may not be considered as an assurance of component characteristics. Components have to be tested for the respective application. Adjustments may be necessary. The use of SEMIKRON products in life support appliances and systems is subject to prior specification and written approval by SEMIKRON. We therefore strongly recommend prior consultation of our personal.

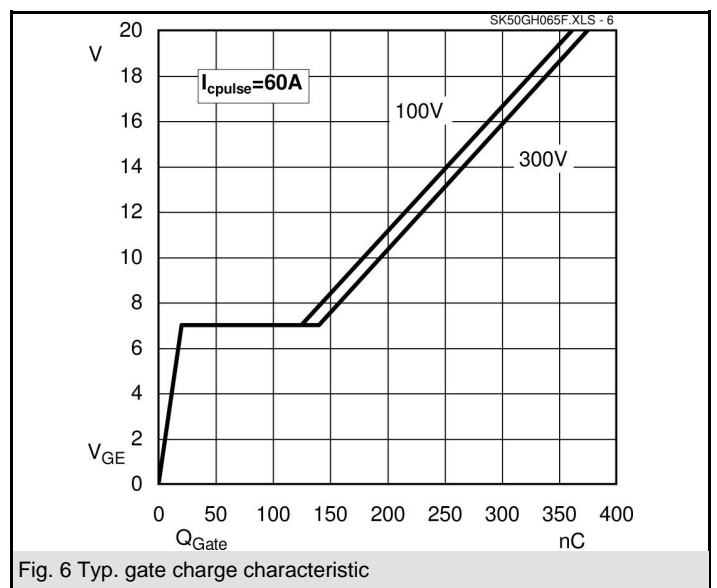
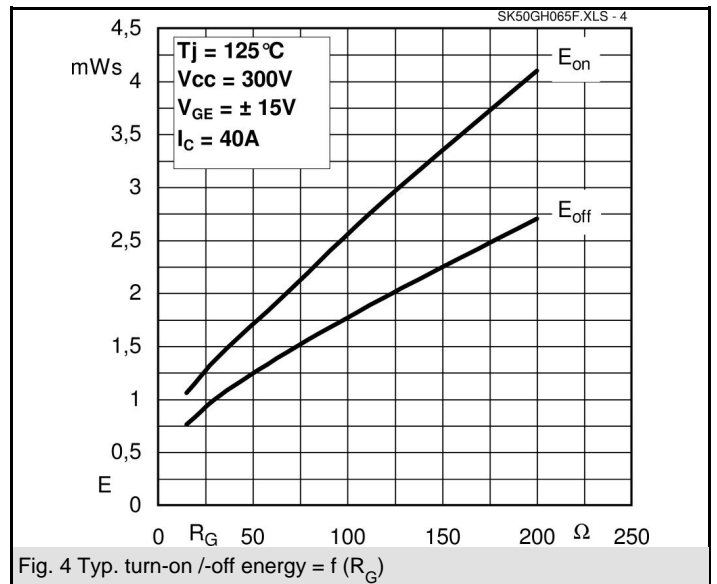
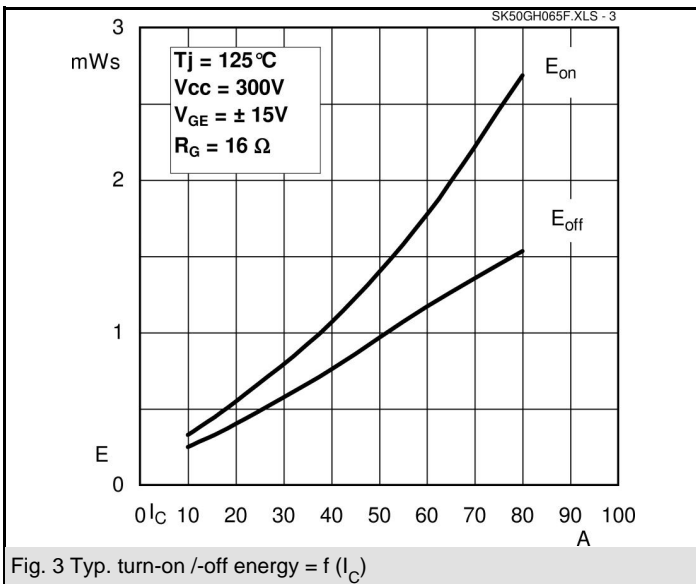
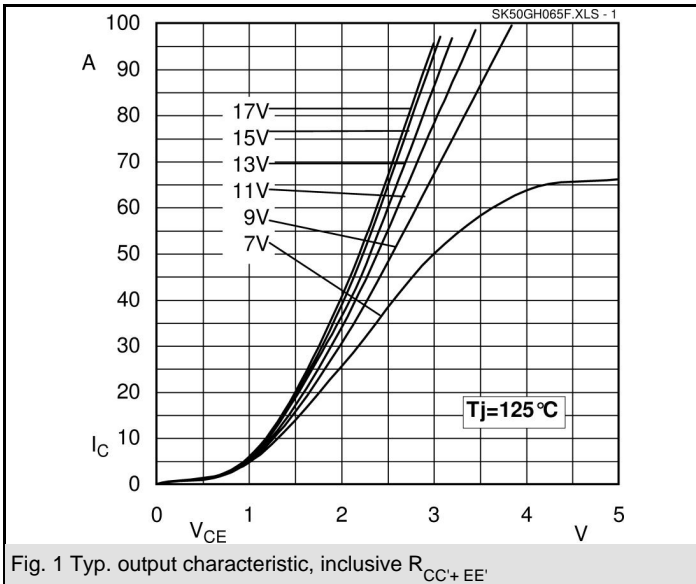

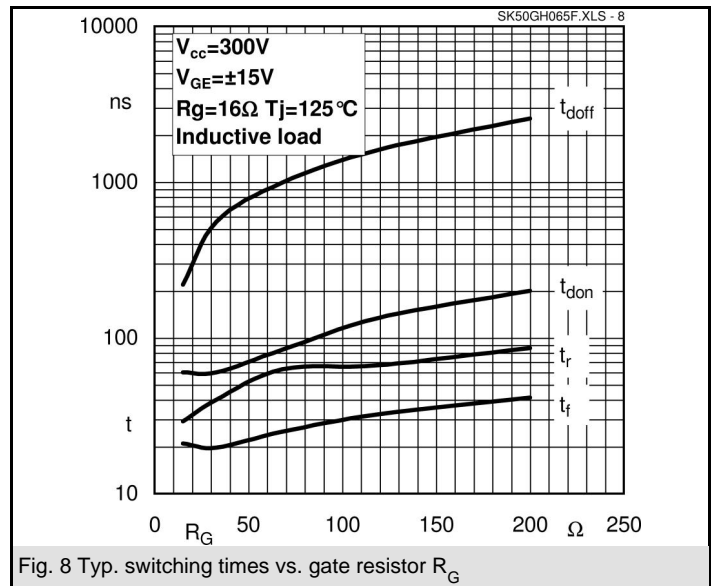
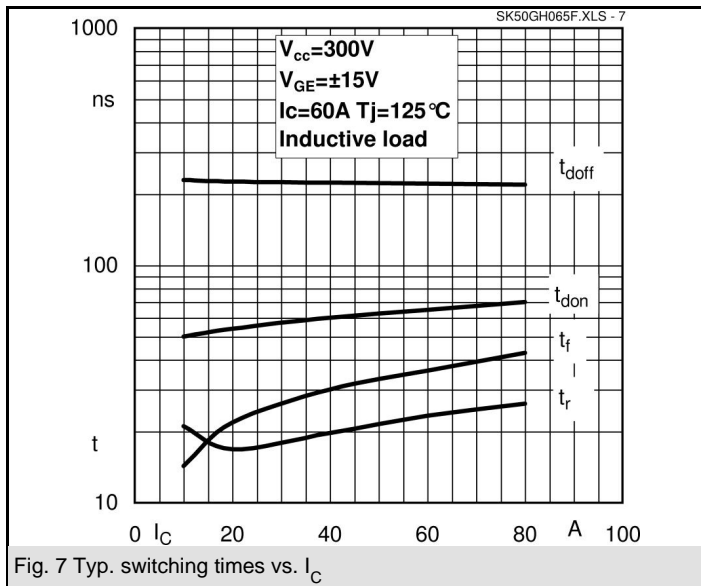

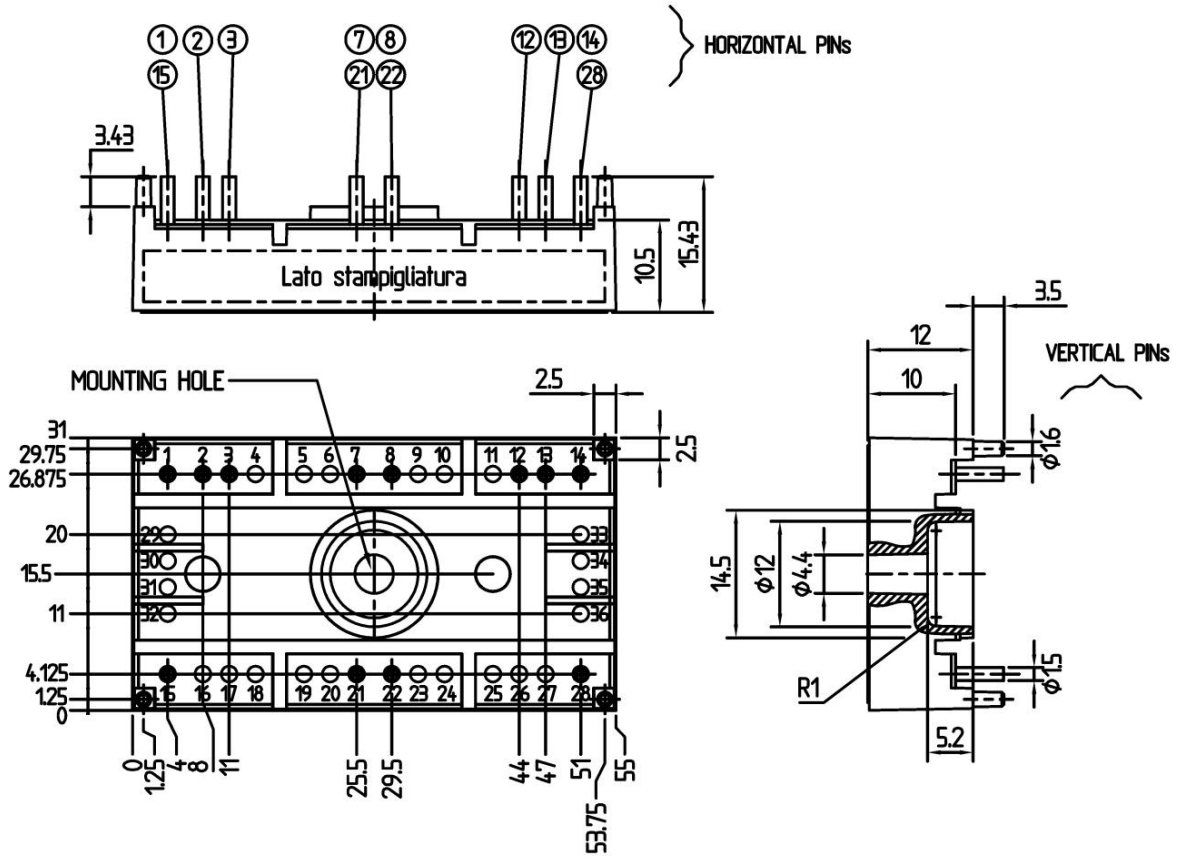

Case T19 (Suggested hole diameter, in the PCB, for solder pins and plastic mounting pins: 2mm)

