

# SK35GD126ET

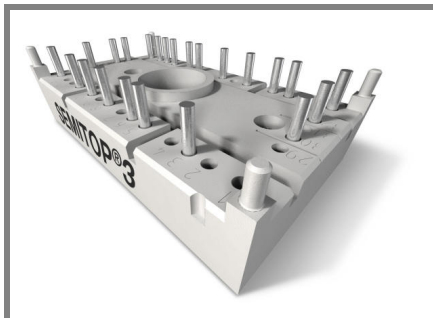

SEMITOP<sup>®</sup> 3

## IGBT Module

SK35GD126ET

Preliminary Data

### Features

- Compact design
- One screw mounting
- Heat transfer and isolation through direct copper bonded aluminium oxide ceramic (DCB)
- Ultrafast NPT technology IGBT
- CAL technology FWD
- Integrated NTC temperature sensor

### Typical Applications\*

- Inverter

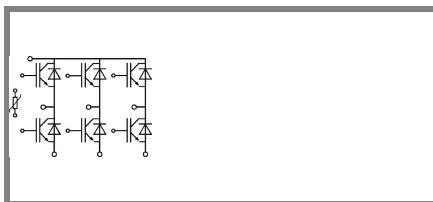

GD-ET

Absolute Maximum Ratings		$T_s = 25\text{ }^\circ\text{C}$ , unless otherwise specified			
Symbol	Conditions	Values			Units
<b>IGBT</b>					
$V_{CES}$	$T_j = 25\text{ }^\circ\text{C}$	1200			V
$I_C$	$T_j = 150\text{ }^\circ\text{C}$	$T_s = 25\text{ }^\circ\text{C}$	40		A
		$T_s = 80\text{ }^\circ\text{C}$	32		A
$I_{CRM}$	$I_{CRM} = 2 \times I_{Cnom}$	70			A
$V_{GES}$		$\pm 20$			V
$t_{psc}$	$V_{CC} = 600\text{ V}; V_{GE} \leq 20\text{ V}; T_j = 125\text{ }^\circ\text{C}$ $V_{CES} < 1200\text{ V}$	10			$\mu\text{s}$
<b>Inverse Diode</b>					
$I_F$	$T_j = 150\text{ }^\circ\text{C}$	$T_s = 25\text{ }^\circ\text{C}$	34		A
		$T_s = 80\text{ }^\circ\text{C}$	23		A
$I_{FRM}$	$I_{FRM} = 2 \times I_{Fnom}$	70			A
<b>Module</b>					
$I_{t(RMS)}$					A
$T_{vj}$		-40 ... +150			$^\circ\text{C}$
$T_{stg}$		-40 ... +125			$^\circ\text{C}$
$V_{isol}$	AC, 1 min.	2500			V

Characteristics		$T_s = 25\text{ }^\circ\text{C}$ , unless otherwise specified				
Symbol	Conditions	min.	typ.	max.	Units	
<b>IGBT</b>						
$V_{GE(th)}$	$V_{GE} = V_{CE}, I_C = 1,5\text{ mA}$	5	5,8	6,5	V	
$I_{CES}$	$V_{GE} = 0\text{ V}, V_{CE} = V_{CES}$	$T_j = 25\text{ }^\circ\text{C}$				mA
		$T_j = 125\text{ }^\circ\text{C}$				mA
$I_{GES}$	$V_{CE} = 0\text{ V}, V_{GE} = 20\text{ V}$	$T_j = 25\text{ }^\circ\text{C}$			600	nA
		$T_j = 125\text{ }^\circ\text{C}$				nA
$V_{CE0}$		$T_j = 25\text{ }^\circ\text{C}$	1		1,2	V
		$T_j = 125\text{ }^\circ\text{C}$	0,9			V
$r_{CE}$	$V_{GE} = 15\text{ V}$	$T_j = 25\text{ }^\circ\text{C}$	20		26	$\text{m}\Omega$
		$T_j = 125\text{ }^\circ\text{C}$	31			$\text{m}\Omega$
$V_{CE(sat)}$	$I_{Cnom} = 35\text{ A}, V_{GE} = 15\text{ V}$	$T_j = 25\text{ }^\circ\text{C}_{chiplev.}$	1,7		2,1	V
		$T_j = 125\text{ }^\circ\text{C}_{chiplev.}$	2			V
$C_{ies}$	$V_{CE} = 25, V_{GE} = 0\text{ V}$	$f = 1\text{ MHz}$	2,5			nF
$C_{oes}$			0,132			nF
$C_{res}$			0,115			nF
$t_{d(on)}$	$R_{Gon} = 15\text{ }\Omega$	$V_{CC} = 600\text{ V}$ $I_C = 35\text{ A}$	85			ns
$t_r$			30			ns
$E_{on}$			4,6			mJ
$t_{d(off)}$	$R_{Goff} = 15\text{ }\Omega$	$T_j = 125\text{ }^\circ\text{C}$ $V_{GE} = \pm 15\text{ V}$	430			ns
$t_f$			90			ns
$E_{off}$			4,3			mJ
$R_{th(j-s)}$	per IGBT	1,05			K/W	

# SK35GD126ET

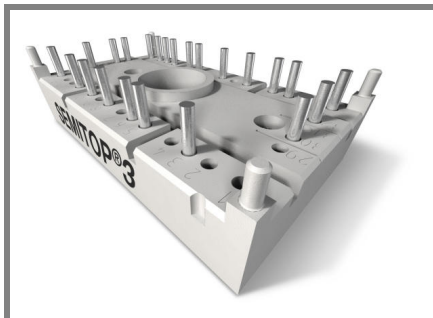

**SEMITOP<sup>®</sup> 3**

## IGBT Module

**SK35GD126ET**

Preliminary Data

### Features

- Compact design
- One screw mounting
- Heat transfer and isolation through direct copper bonded aluminium oxide ceramic (DCB)
- Ultrafast NPT technology IGBT
- CAL technology FWD
- Integrated NTC temperature sensor

### Typical Applications\*

- Inverter

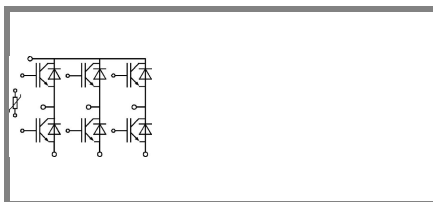

**GD-ET**

Characteristics				min.	typ.	max.	Units
<b>Inverse Diode</b>							
$V_F = V_{EC}$	$I_{Fnom} = 35 \text{ A}; V_{GE} = 0 \text{ V}$	$T_j = 25 \text{ }^\circ\text{C}_{\text{chiplev.}}$		1,8		2,1	V
		$T_j = 125 \text{ }^\circ\text{C}_{\text{chiplev.}}$		1,8			V
$V_{F0}$		$T_j = 25 \text{ }^\circ\text{C}$		1		1,1	V
		$T_j = 125 \text{ }^\circ\text{C}$		0,8			V
$r_F$		$T_j = 25 \text{ }^\circ\text{C}$		23		29	m $\Omega$
		$T_j = 125 \text{ }^\circ\text{C}$		31			m $\Omega$
$I_{RRM}$	$I_F = 35 \text{ A}$	$T_j = 125 \text{ }^\circ\text{C}$		43			A
$Q_{rr}$	$di/dt = -1330 \text{ A}/\mu\text{s}$			7			$\mu\text{C}$
$E_{rr}$	$V_{CC} = 600\text{V}$			2,9			mJ
$R_{th(j-s)D}$	per diode					1,7	K/W
$M_s$	to heat sink			2,25		2,5	Nm
w				30			g
<b>Temperature sensor</b>							
$R_{100}$	$T_s = 100^\circ\text{C}$ ( $R_{25} = 5\text{k}\Omega$ )			493 $\pm$ 5%			$\Omega$

This is an electrostatic discharge sensitive device (ESDS), international standard IEC 60747-1, Chapter IX.

\* The specifications of our components may not be considered as an assurance of component characteristics. Components have to be tested for the respective application. Adjustments may be necessary. The use of SEMIKRON products in life support appliances and systems is subject to prior specification and written approval by SEMIKRON. We therefore strongly recommend prior consultation of our personal.

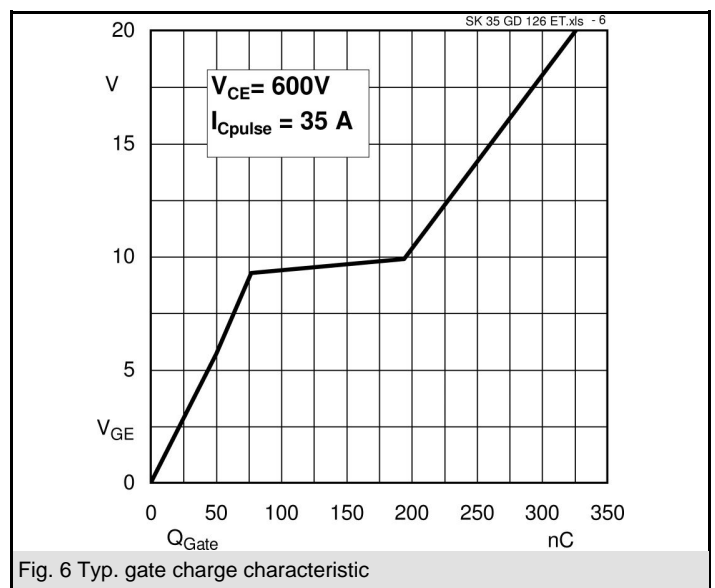
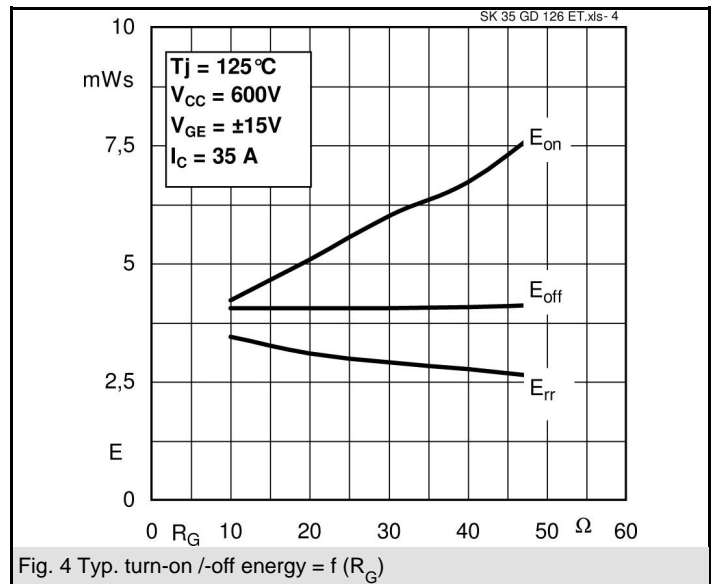
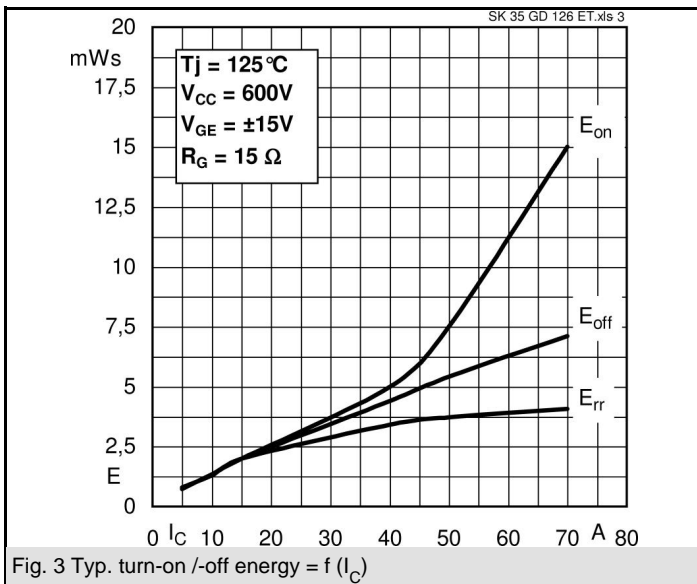
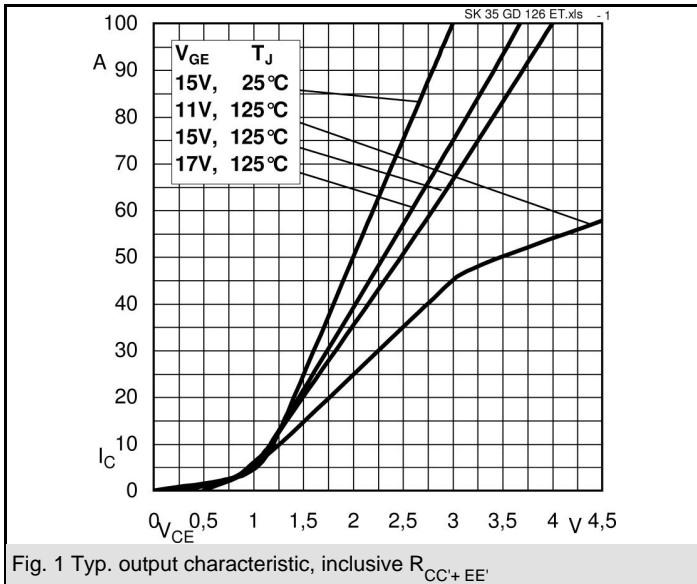

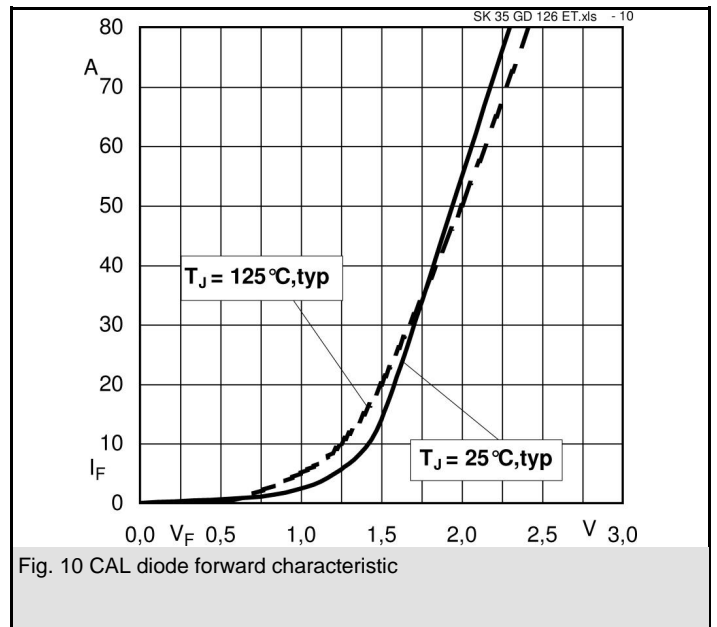
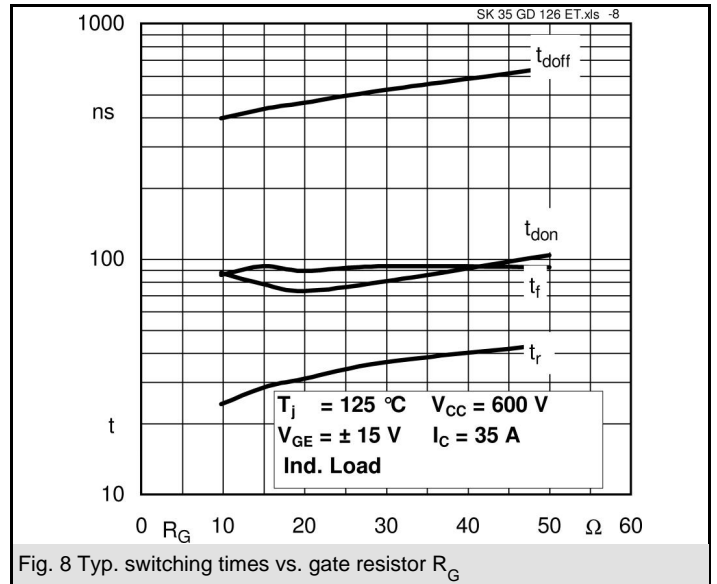
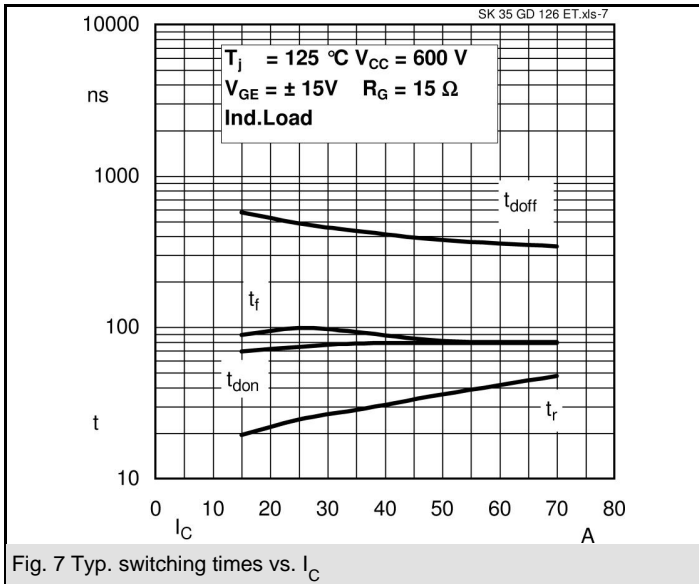

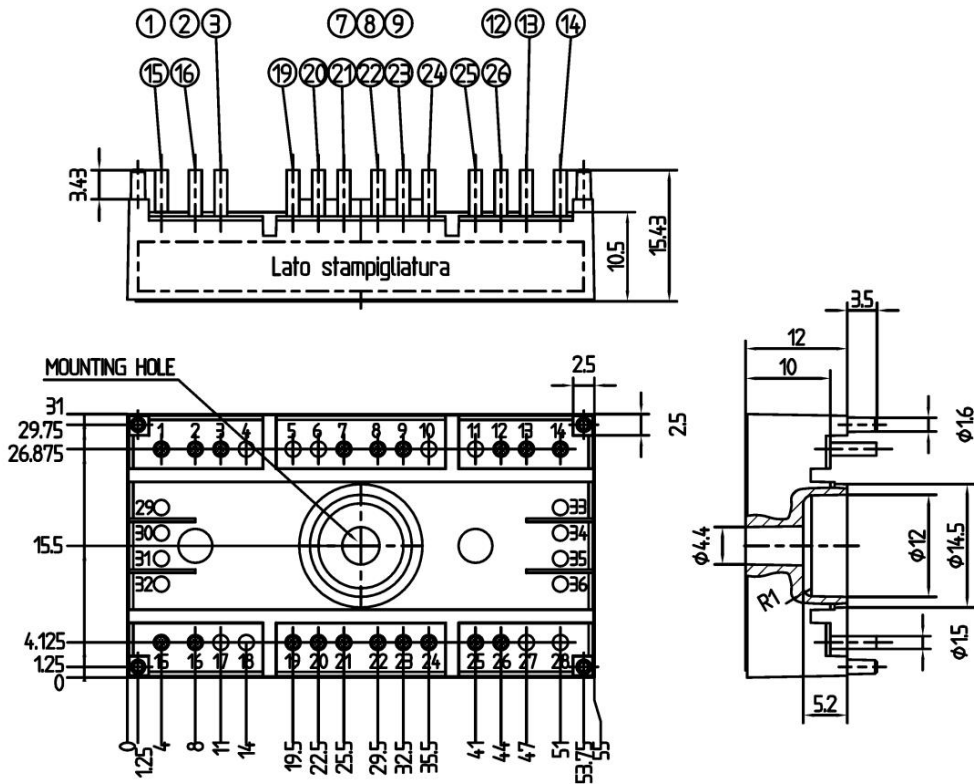

Case T52 (Suggested hole diameter, in the PCB, for solder pins and plastic mounting pins: 2mm)

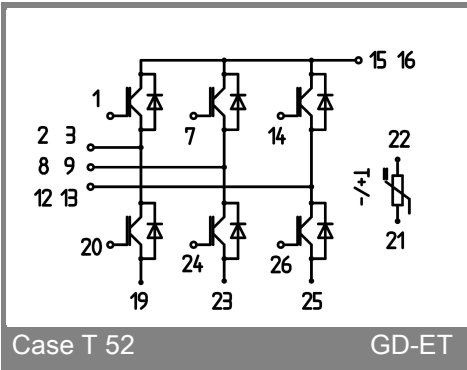

Case T 52

GD-ET