

# SK35GB12T4

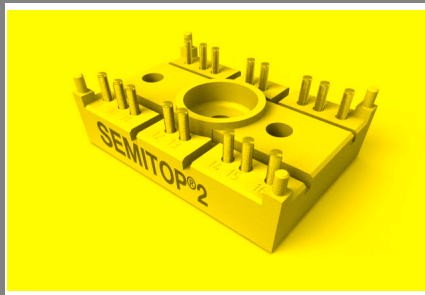

**SEMITOP<sup>®</sup> 2**

## IGBT Module

**SK35GB12T4**

Target Data

### Features

- One screw mounting module
- Trench4 IGBT technology
- CAL4 technology FWD

### Typical Applications\*

### Remarks

- $V_{CE,sat}$ ,  $V_F$  = chip level value

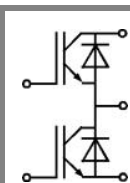

GB

Absolute Maximum Ratings		$T_s = 25\text{ °C}$ , unless otherwise specified		
Symbol	Conditions	Values		Units
<b>IGBT</b>				
$V_{CES}$	$T_j = 25\text{ °C}$	1200		V
$I_C$	$T_j = 175\text{ °C}$	$T_s = 25\text{ °C}$	44	A
		$T_s = 70\text{ °C}$	35	A
$I_{CRM}$	$I_{CRM} = 3 \times I_{Cnom}$	105		A
$V_{GES}$		± 20		V
$t_{psc}$	$V_{CC} = 800\text{ V}$ ; $V_{GE} \leq 15\text{ V}$ ; $T_j = 150\text{ °C}$ $V_{CES} < 1200\text{ V}$	10		µs
<b>Inverse Diode</b>				
$I_F$	$T_j = 175\text{ °C}$	$T_s = 25\text{ °C}$	40	A
		$T_s = 70\text{ °C}$	31	A
$I_{FRM}$	$I_{FRM} = 3 \times I_{Fnom}$	105		A
$I_{FSM}$	$t_p = 10\text{ ms}$ ; half sine wave $T_j = 150\text{ °C}$	225		A
<b>Module</b>				
$I_{t(RMS)}$				A
$T_{vj}$		-40 ... +175		°C
$T_{stg}$		-40 ... +125		°C
$V_{isol}$	AC, 1 min.	2500		V

Characteristics		$T_s = 25\text{ °C}$ , unless otherwise specified			
Symbol	Conditions	min.	typ.	max.	Units
<b>IGBT</b>					
$V_{GE(th)}$	$V_{GE} = V_{CE}$ , $I_C = 1,2\text{ mA}$	5	5,8	6,5	V
$I_{CES}$	$V_{GE} = 0\text{ V}$ , $V_{CE} = V_{CES}$	$T_j = 25\text{ °C}$	0,005		mA
		$T_j = 125\text{ °C}$			mA
$I_{GES}$	$V_{CE} = 0\text{ V}$ , $V_{GE} = 20\text{ V}$	$T_j = 25\text{ °C}$	120		nA
		$T_j = 125\text{ °C}$			nA
$V_{CE0}$		$T_j = 25\text{ °C}$	1,1	1,3	V
		$T_j = 150\text{ °C}$	1	1,2	V
$r_{CE}$	$V_{GE} = 15\text{ V}$	$T_j = 25\text{ °C}$	21,4		mΩ
		$T_j = 150\text{ °C}$	35,7		mΩ
$V_{CE(sat)}$	$I_{Cnom} = 35\text{ A}$ , $V_{GE} = 15\text{ V}$	$T_j = 25\text{ °C}_{chiplev.}$	1,85	2,05	V
		$T_j = 150\text{ °C}_{chiplev.}$	2,25	2,45	V
$C_{ies}$	$V_{CE} = 25$ , $V_{GE} = 0\text{ V}$	$f = 1\text{ MHz}$	1,95		nF
$C_{oes}$			0,155		nF
$C_{res}$			0,115		nF
$Q_G$	$V_{GE} = -7V...+15V$	189		nC	
$t_{d(on)}$	$R_{Gon} = 22\text{ }\Omega$	$V_{CC} = 600V$ $I_C = 35A$	28		ns
$t_r$			25		ns
$E_{on}$	$R_{Goff} = 22\text{ }\Omega$ $di/dt = 2900\text{ A}/\mu s$	$T_j = 150\text{ °C}$ $V_{GE} = \pm 15\text{ V}$	3,27		mJ
$t_{d(off)}$			303		ns
$t_f$			70		ns
$E_{off}$			3,3		mJ
$R_{th(j-s)}$	per IGBT	1,21		K/W	

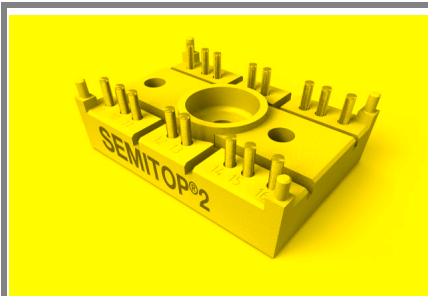

**SEMITOP® 2**

## IGBT Module

**SK35GB12T4**

Target Data

### Features

- One screw mounting module
- Trench4 IGBT technology
- CAL4 technology FWD

### Typical Applications\*

### Remarks

- $V_{CE,sat}$ ,  $V_F$  = chip level value

### Characteristics

Symbol	Conditions	min.	typ.	max.	Units
<b>Inverse Diode</b>					
$V_F = V_{EC}$	$I_{Fnom} = 35 \text{ A}; V_{GE} = 0 \text{ V}$	$T_j = 25 \text{ }^\circ\text{C}_{chiplev.}$	2,3	2,62	V
		$T_j = 150 \text{ }^\circ\text{C}_{chiplev.}$	2,29	2,62	V
$V_{F0}$		$T_j = 25 \text{ }^\circ\text{C}$	1,3	1,5	V
		$T_j = 150 \text{ }^\circ\text{C}$	0,9	1,1	V
$r_F$		$T_j = 25 \text{ }^\circ\text{C}$	27	32	mΩ
		$T_j = 150 \text{ }^\circ\text{C}$	39,7	43,4	mΩ
$I_{RRM}$	$I_F = 35 \text{ A}$		30		A
$Q_{rr}$	$di/dt = 2900 \text{ A}/\mu\text{s}$		2		μC
$E_{rr}$	$V_{CC} = 600\text{V}$		1,46		mJ
$R_{th(j-s)D}$	per diode		1,55		K/W
$M_s$	to heat sink	2,25		2,5	Nm
w			30		g

This is an electrostatic discharge sensitive device (ESDS), international standard IEC 60747-1, Chapter IX.

\* The specifications of our components may not be considered as an assurance of component characteristics. Components have to be tested for the respective application. Adjustments may be necessary. The use of SEMIKRON products in life support appliances and systems is subject to prior specification and written approval by SEMIKRON. We therefore strongly recommend prior consultation of our personal.



**GB**

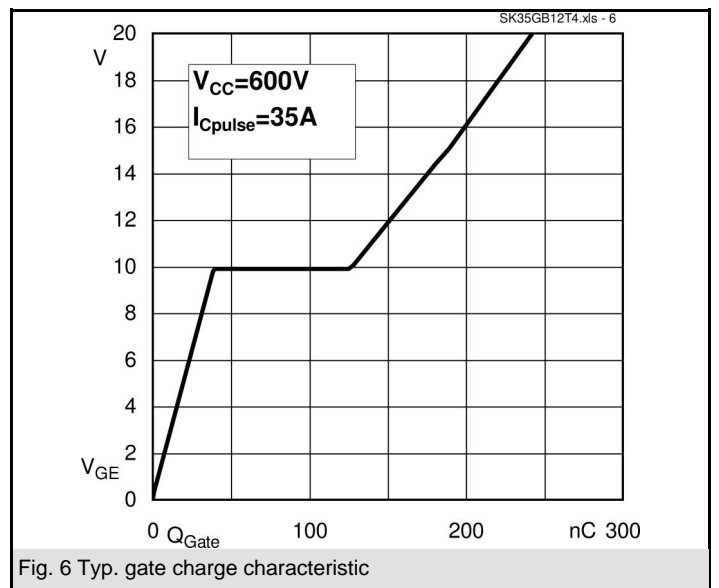
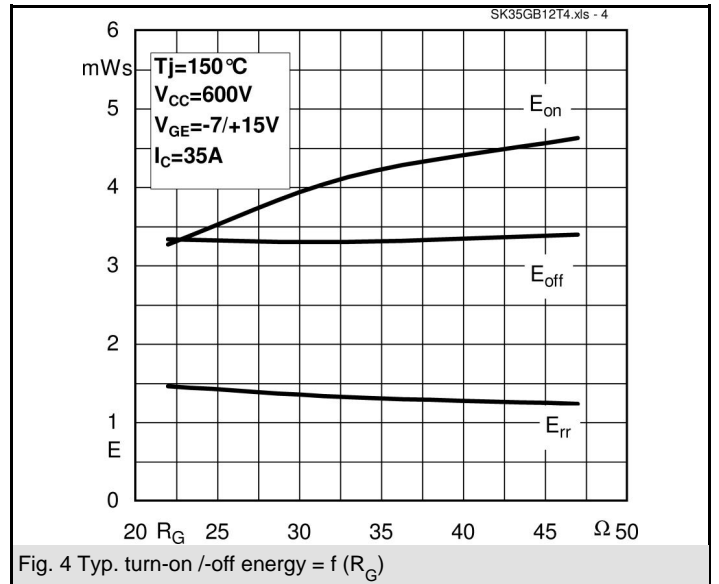
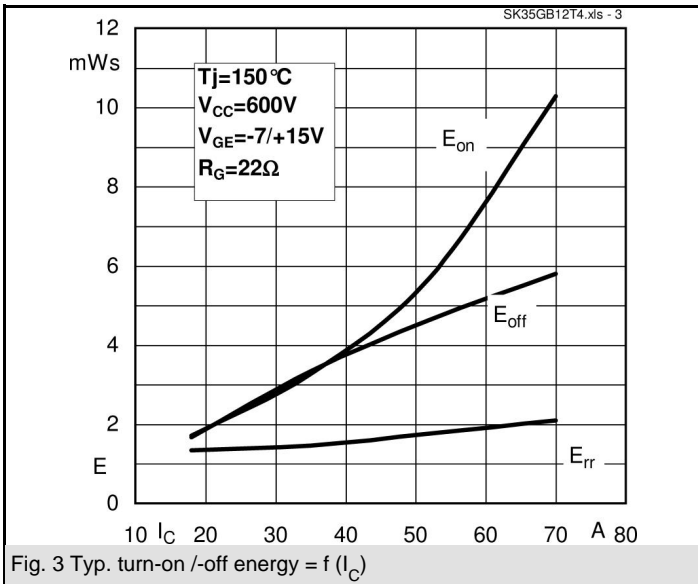
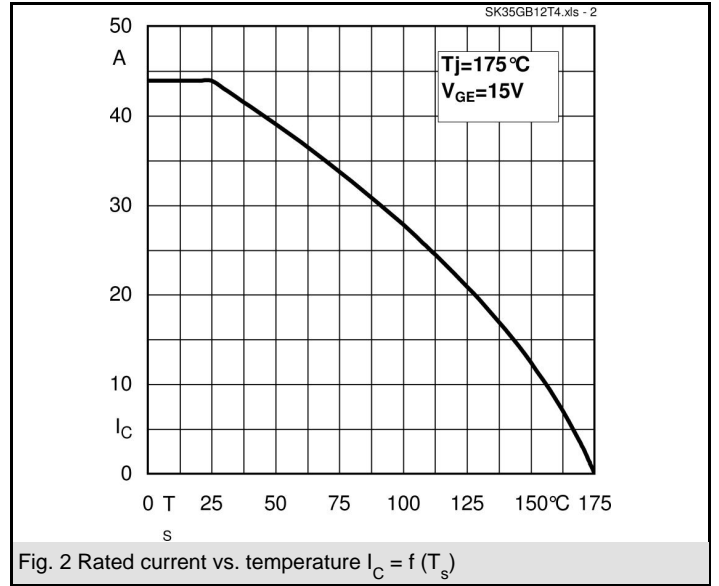
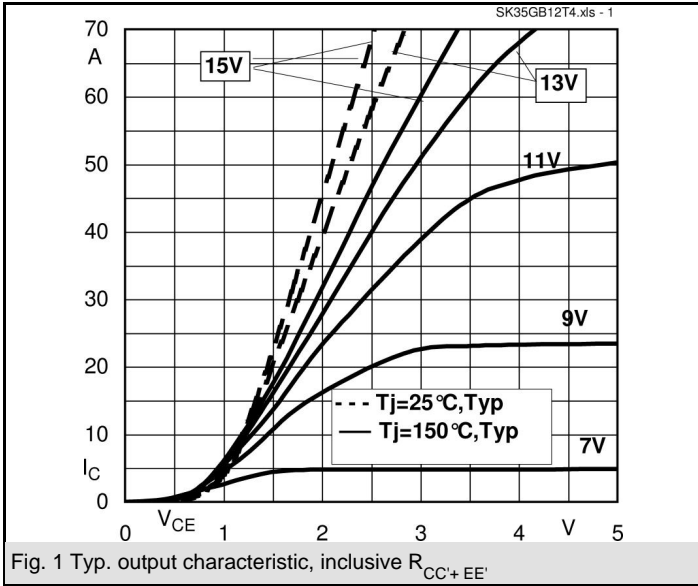

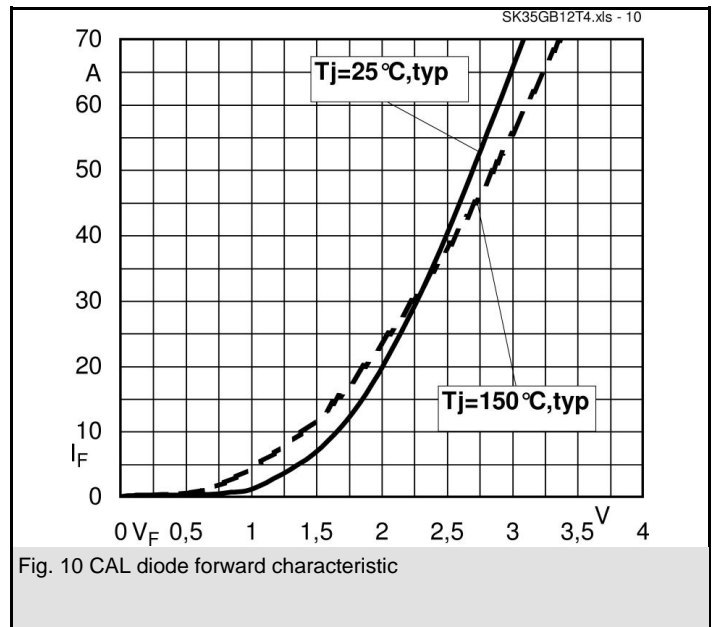
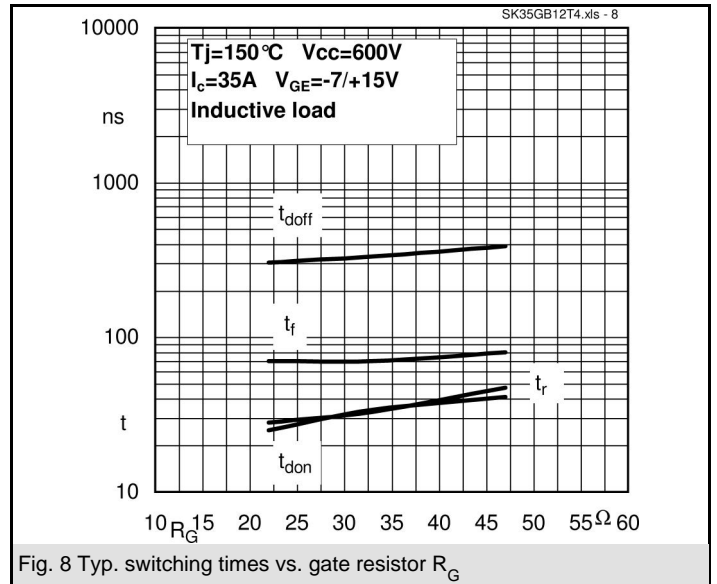
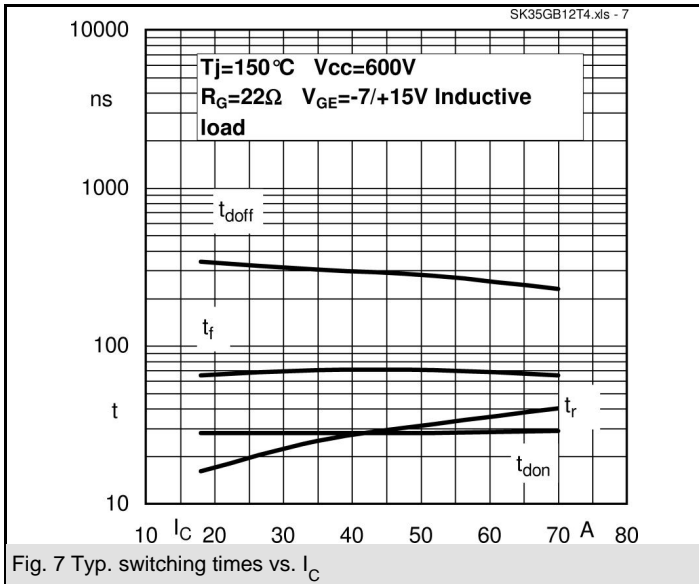

# SK35GB12T4

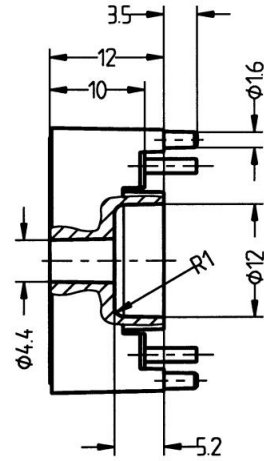
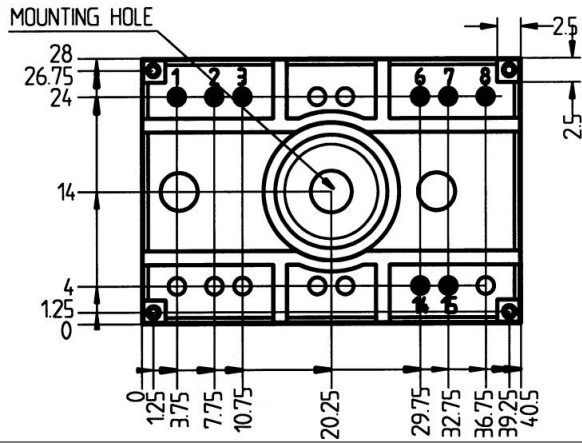
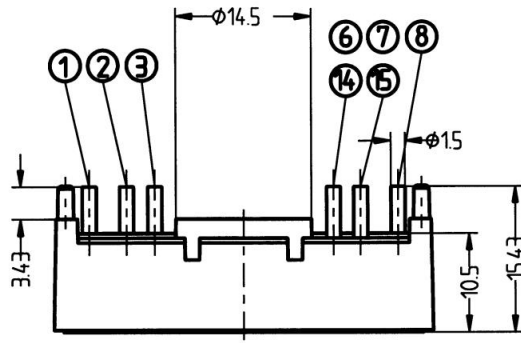

Case T32 (Suggested hole diameter for solder pins and plastic mounting pins: 2mm)

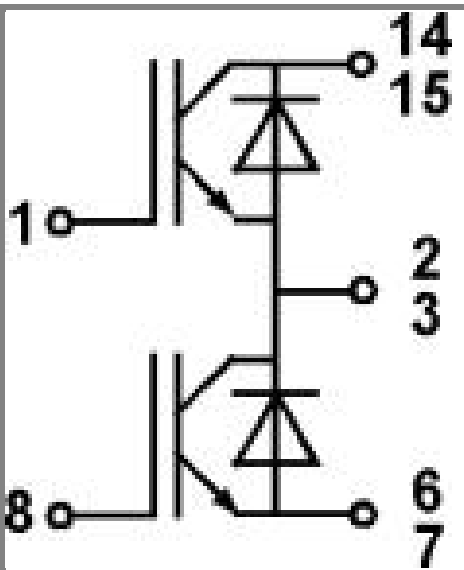

Case T 32

GB