

SKM 75GD123D



SEMITRANS® 6

IGBT Modules

SKM 75GD123DL

SKM 75GD123D

SKM 75GDL123D

Features

- MOS input (voltage controlled)
- N channel, homogeneous Si
- Low inductance case
- Very low tail current with low temperature dependence
- High short circuit capability, self limiting to $6 \times I_{Cnom}$
- Latch-up free
- Fast & soft inverse Cal diodes
- Isolated copper baseplate using DCB Direct Bonding Technology
- Large clearance (9 mm) and creepage distance (13 mm)

Typical Applications

- Switched mode power supplies
- DC servo and robot drives
- Three phase inverters for AC motor speed control
- Switching (not for linear use)

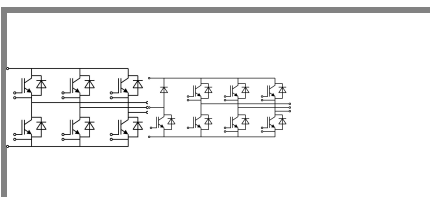

GD GD_L

Absolute Maximum Ratings		$T_c = 25^\circ\text{C}$, unless otherwise specified		
Symbol	Conditions	Values		Units
IGBT				
V_{CES}	$T_j = 25^\circ\text{C}$	1200		V
I_C	$T_j = 150^\circ\text{C}$	$T_{case} = 25^\circ\text{C}$	75	A
		$T_{case} = 80^\circ\text{C}$	50	A
I_{CRM}	$I_{CRM} = 2 \times I_{Cnom}$	100		A
V_{GES}		± 20		V
t_{psc}	$V_{CC} = 600\text{ V}; V_{GE} \leq 20\text{ V}; T_j = 125^\circ\text{C}$ $V_{CES} < 1200\text{ V}$	10		μs
Inverse Diode				
I_F	$T_j = 150^\circ\text{C}$	$T_{case} = 25^\circ\text{C}$	75	A
		$T_{case} = 80^\circ\text{C}$	50	A
I_{FRM}	$I_{FRM} = 2 \times I_{Fnom}$	100		A
I_{FSM}	$t_p = 10\text{ ms}; \text{sin.}$	$T_j = 150^\circ\text{C}$	550	A
Module				
$I_{t(RMS)}$		100		A
T_{vj}		- 40 ... + 150		$^\circ\text{C}$
T_{stg}		- 40 ... + 125		$^\circ\text{C}$
V_{isol}	AC, 1 min.	2500		V

Characteristics		$T_c = 25^\circ\text{C}$, unless otherwise specified			
Symbol	Conditions	min.	typ.	max.	Units
IGBT					
$V_{GE(th)}$	$V_{GE} = V_{CE}; I_C = 2\text{ mA}$	4,5	5,5	6,5	V
I_{CES}	$V_{GE} = 0\text{ V}; V_{CE} = V_{CES}$		0,4	1,2	mA
V_{CE0}		$T_j = 25^\circ\text{C}$	1,4	1,6	V
		$T_j = 125^\circ\text{C}$	1,6	1,8	V
r_{CE}	$V_{GE} = 15\text{ V}$	$T_j = 25^\circ\text{C}$	22	28	$\text{m}\Omega$
		$T_j = 125^\circ\text{C}$	30	38	$\text{m}\Omega$
$V_{CE(sat)}$	$I_{Cnom} = 50\text{ A}; V_{GE} = 15\text{ V}$	$T_j = ^\circ\text{C}_{chiplev.}$	2,5	3	V
C_{ies}	$V_{CE} = 25; V_{GE} = 0\text{ V}$	$f = 1\text{ MHz}$	3,3	4,3	nF
C_{oes}			0,5	0,6	nF
C_{res}			0,22	0,3	nF
$t_{d(on)}$	$R_{Gon} = 22\ \Omega$	$V_{CC} = 600\text{ V}$ $I_C = 50\text{ A}$	44	100	ns
t_r			56	100	ns
E_{on}			8		mJ
$t_{d(off)}$	$R_{Goff} = 22\ \Omega$	$T_j = 125^\circ\text{C}$ $V_{GE} = \pm 15\text{ V}$	380	500	ns
t_f			70	100	ns
E_{off}			5		mJ
$R_{th(j-c)}$	per IGBT			0,32	K/W

SKM 75GD123D



SEMITRANS® 6

IGBT Modules

SKM 75GD123DL

SKM 75GD123D

SKM 75GDL123D

Features

- MOS input (voltage controlled)
- N channel, homogeneous Si
- Low inductance case
- Very low tail current with low temperature dependence
- High short circuit capability, self limiting to $6 \times I_{Cnom}$
- Latch-up free
- Fast & soft inverse Cal diodes
- Isolated copper baseplate using DCB Direct Bonding Technology
- Large clearance (9 mm) and creepage distance (13 mm)

Typical Applications

- Switched mode power supplies
- DC servo and robot drives
- Three phase inverters for AC motor speed control
- Switching (not for linear use)

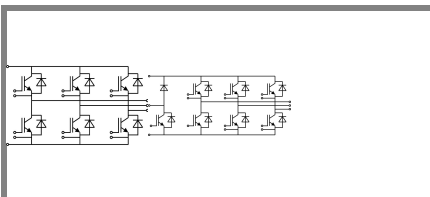

GD

GDL

Characteristics			min.	typ.	max.	Units
Symbol	Conditions					
Inverse Diode						
$V_F = V_{EC}$	$I_{Fnom} = 50 \text{ A}; V_{GE} = 0 \text{ V}$	$T_j = 25 \text{ }^\circ\text{C}_{chiplev.}$		2	2,5	V
		$T_j = 125 \text{ }^\circ\text{C}_{chiplev.}$		1,8		V
V_{F0}		$T_j = 25 \text{ }^\circ\text{C}$		1,1	1,2	V
		$T_j = 125 \text{ }^\circ\text{C}$				V
r_F		$T_j = 25 \text{ }^\circ\text{C}$		18	26	mΩ
		$T_j = 125 \text{ }^\circ\text{C}$				mΩ
I_{RRM}	$I_F = 50 \text{ A}$	$T_j = 125 \text{ }^\circ\text{C}$		35		A
Q_{rr}	$di/dt = 800 \text{ A}/\mu\text{s}$			7		μC
E_{rr}	$V_{GE} = 0 \text{ V}; V_{CC} = 600 \text{ V}$			2,2		mJ
$R_{th(j-c)D}$	per diode				0,6	K/W
Module						
L_{CE}					60	nH
$R_{th(c-s)}$	per module				0,05	K/W
M_s	to heat sink M5					Nm
M_t	to terminals		4		5	Nm
w					175	g

This is an electrostatic discharge sensitive device (ESDS), international standard IEC 60747-1, Chapter IX.

This technical information specifies semiconductor devices but promises no characteristics. No warranty or guarantee expressed or implied is made regarding delivery, performance or suitability.

SKM 75GD123D



SEMITRANS® 6

IGBT Modules

SKM 75GD123DL

SKM 75GD123D

SKM 75GDL123D

Features

- MOS input (voltage controlled)
- N channel, homogeneous Si
- Low inductance case
- Very low tail current with low temperature dependence
- High short circuit capability, self limiting to $6 \times I_{cnom}$
- Latch-up free
- Fast & soft inverse Cal diodes
- Isolated copper baseplate using DCB Direct Bonding Technology
- Large clearance (9 mm) and creepage distance (13 mm)

Typical Applications

- Switched mode power supplies
- DC servo and robot drives
- Three phase inverters for AC motor speed control
- Switching (not for linear use)

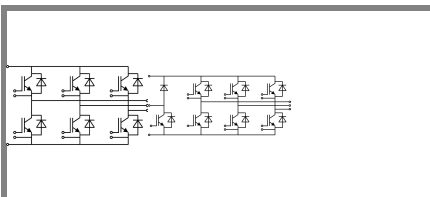

GD

GDL

Z_{th}		Conditions	Values	Units
Symbol				
$Z_{th(j-c)I}$				
R_{θ}	$i = 1$		240	mk/W
R_{θ}	$i = 2$		68	mk/W
R_{θ}	$i = 3$		9,2	mk/W
R_{θ}	$i = 4$		2,8	mk/W
τ_{θ}	$i = 1$		0,06	s
τ_{θ}	$i = 2$		0,0228	s
τ_{θ}	$i = 3$		0,0013	s
τ_{θ}	$i = 4$		0,0002	s
$Z_{th(j-c)D}$				
R_{θ}	$i = 1$		400	mk/W
R_{θ}	$i = 2$		168	mk/W
R_{θ}	$i = 3$		28	mk/W
R_{θ}	$i = 4$		4	mk/W
τ_{θ}	$i = 1$		0,0831	s
τ_{θ}	$i = 2$		0,0112	s
τ_{θ}	$i = 3$		0,0013	s
τ_{θ}	$i = 4$		0,08	s

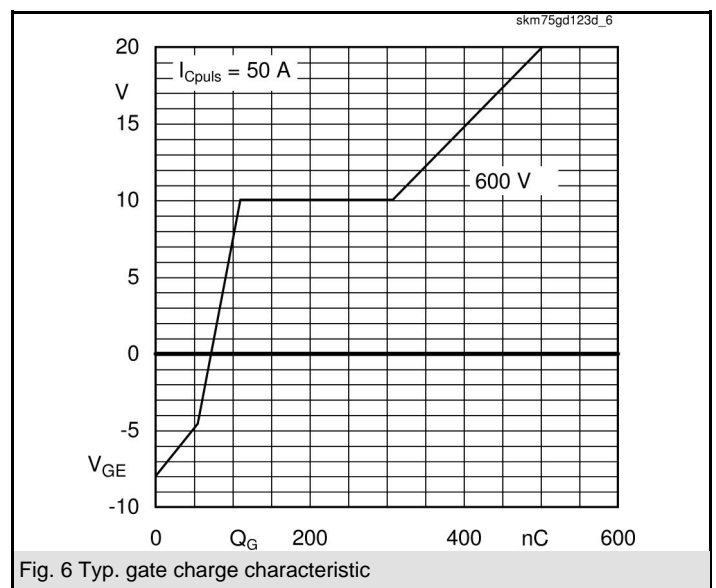
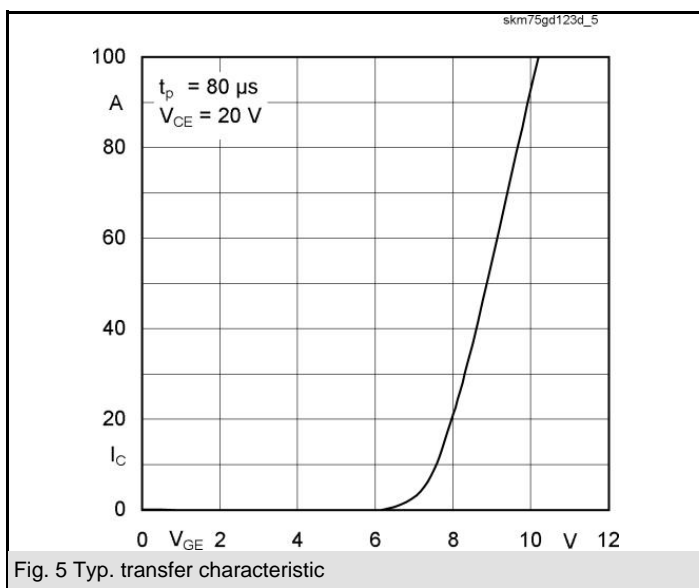
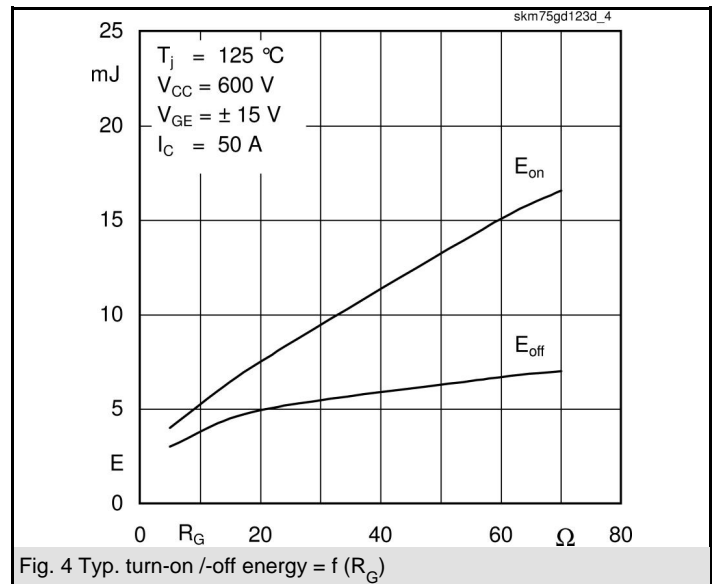
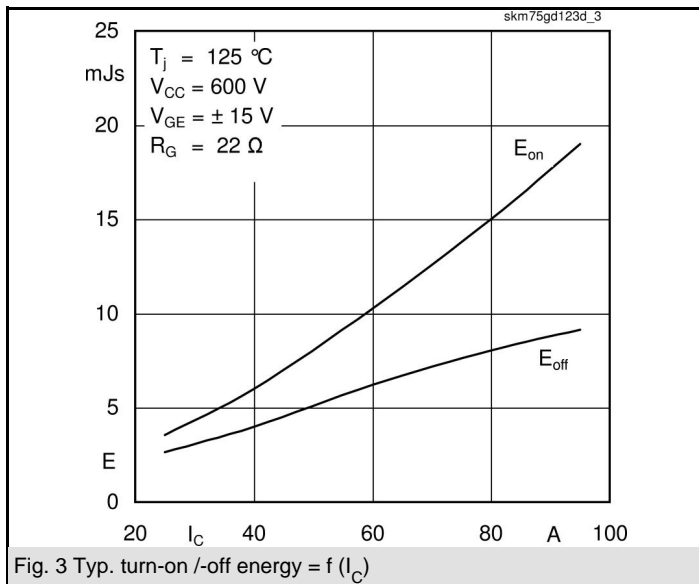
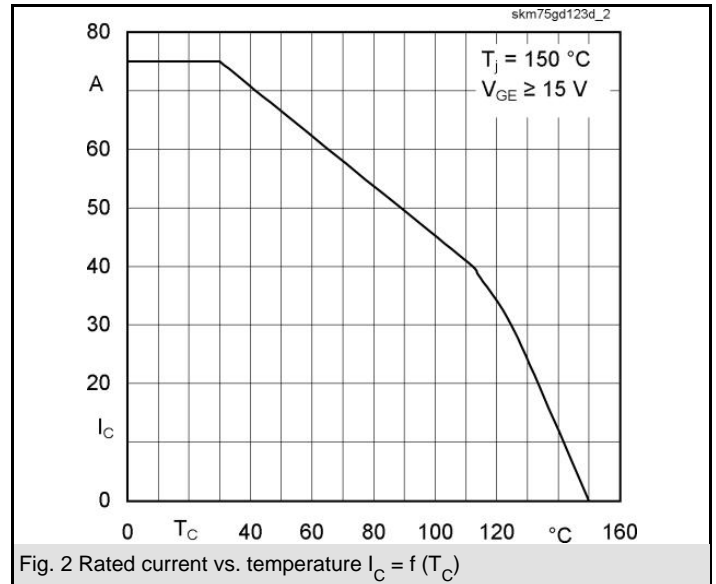
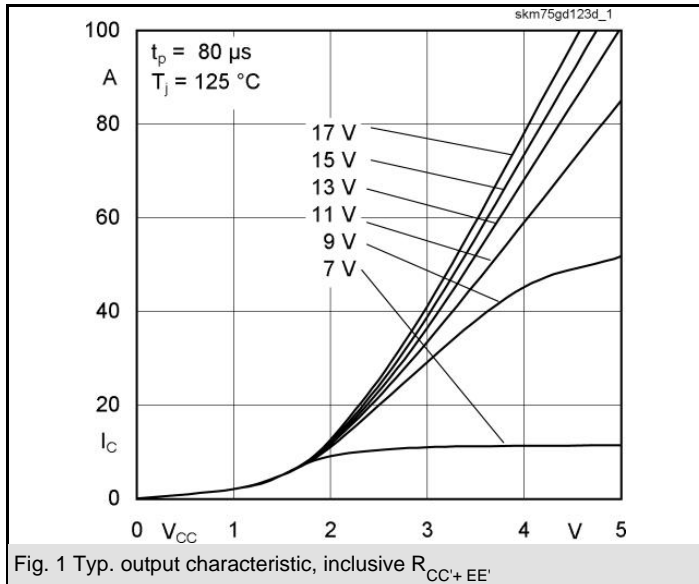

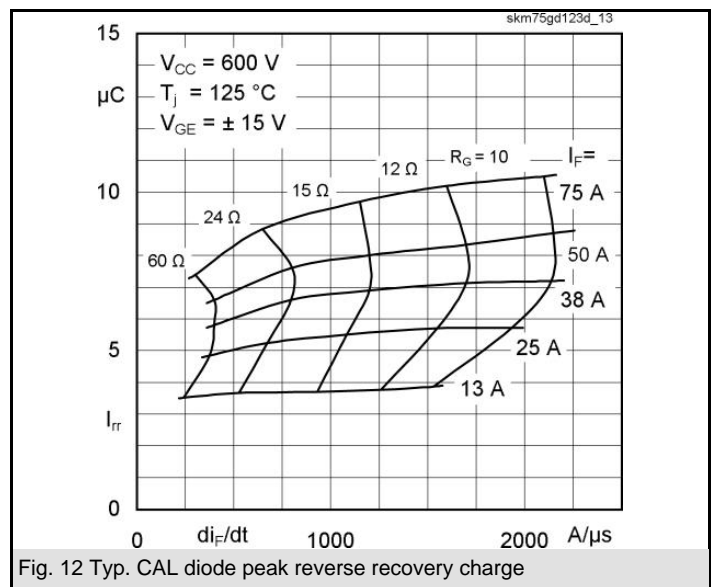
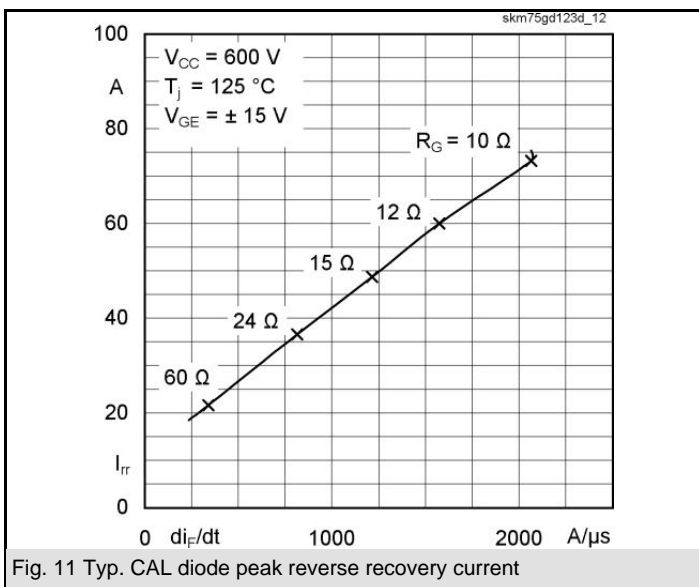
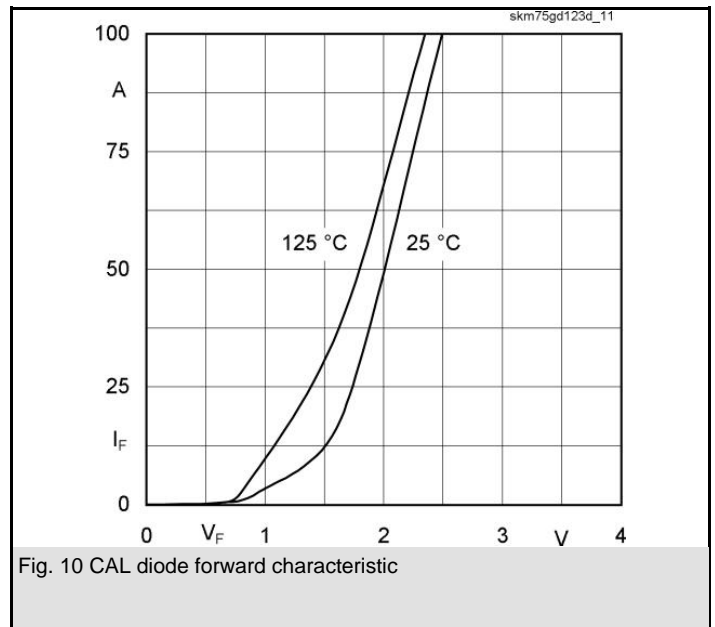
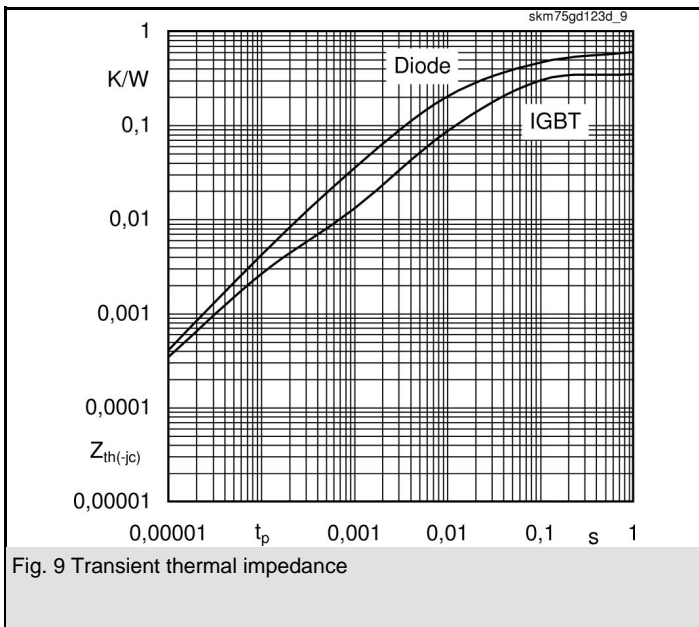
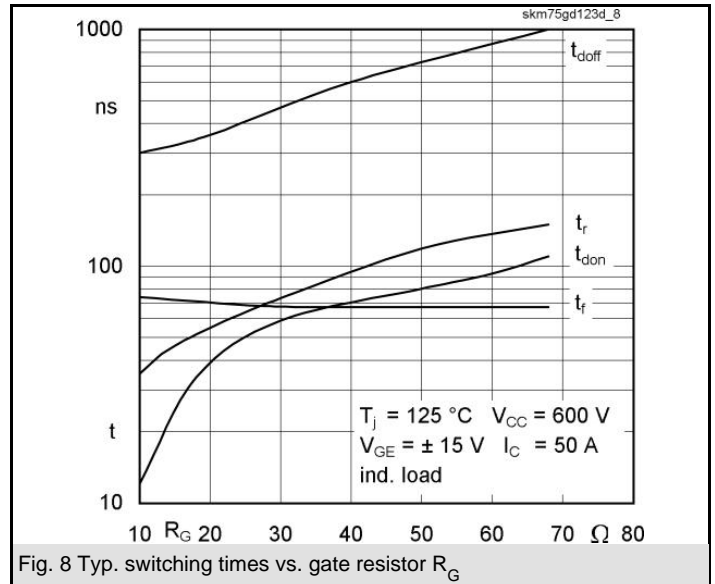
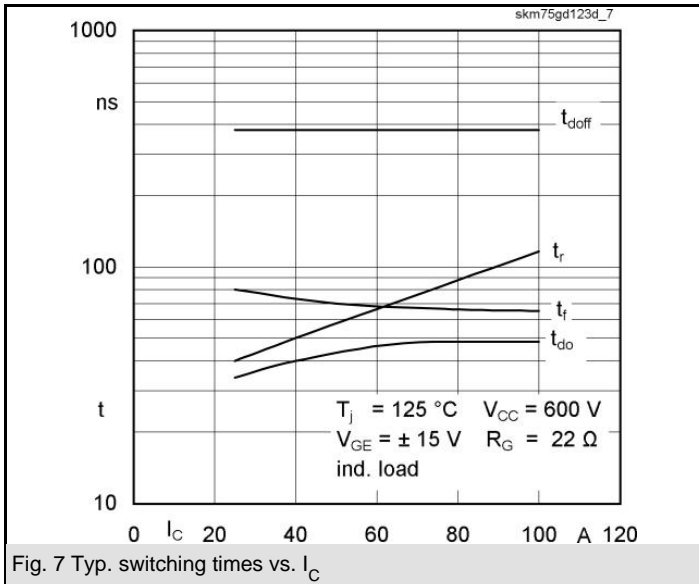

SKM 75GD123D

UL Recognized

File 63 532

CASED68

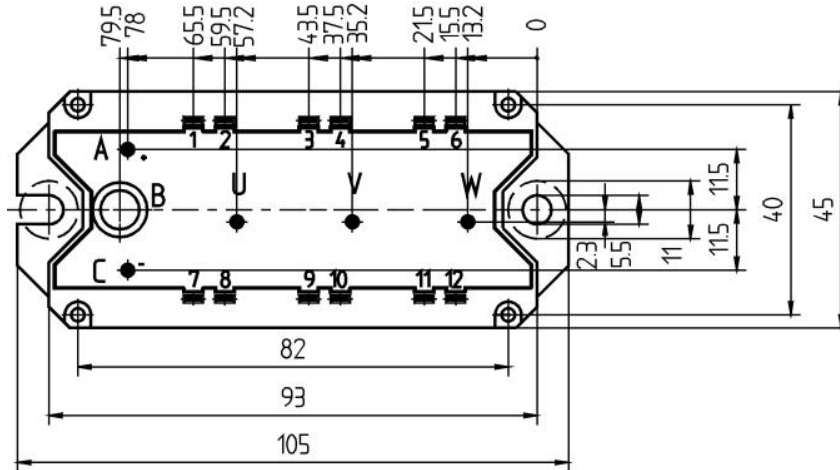
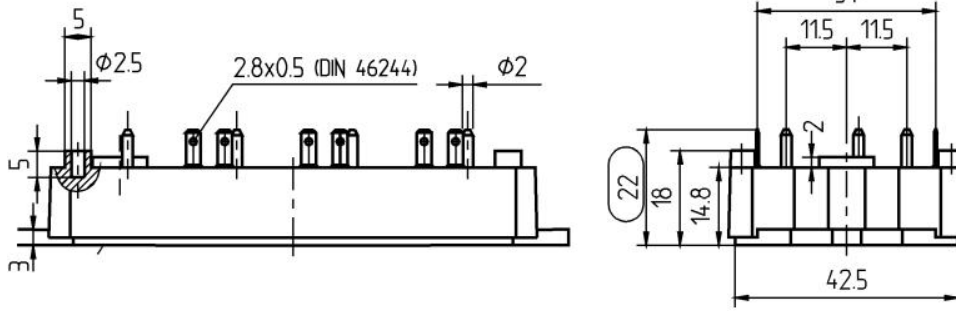

Case D 56a

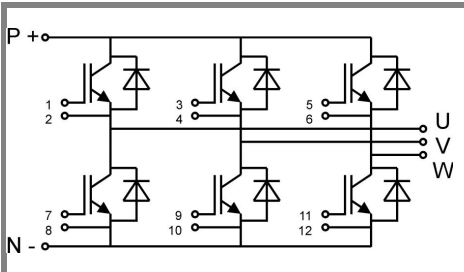

Case D 67

GD

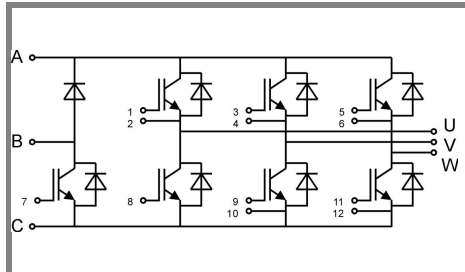

Case D 73

GDL