

SKM 300GB063D



SEMITRANS[®] 3

Superfast IGBT Modules

SKM 300GB063D

SKM 300GAR063D

SKM 300GAL063D

Features

- NPT- Non punch-through IGBT
- Low tail current with low temperature dependence
- High short circuit capability, self limiting if term. G is clamped to E
- Pos. temp.-coeff. of V_{CEsat}
- 50 % less turn off losses
- 30 % less short circuit current
- Very low C_{ies} , C_{oes} , C_{res}
- Latch-up free
- Fast & soft inverse CAL diodes
- Isolated copper baseplate using DCB Direct Copper Bonding Technology without hard mould
- Large clearance (13 mm) and creepage distances (20 mm)

Typical Applications

- Switching (not for linear use)
- Switched mode power supplies
- AC inverter servo drives
- UPS uninterruptable power supplies
- Welding inverters

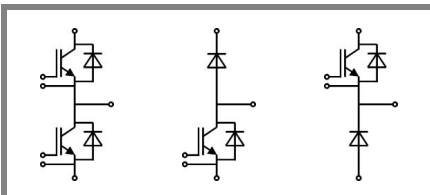

GB

GAL

GAR

Absolute Maximum Ratings		$T_c = 25\text{ }^\circ\text{C}$, unless otherwise specified		
Symbol	Conditions	Values		Units
IGBT				
V_{CES}	$T_j = 25\text{ }^\circ\text{C}$	600		V
I_C	$T_j = 150\text{ }^\circ\text{C}$	$T_{case} = 25\text{ }^\circ\text{C}$	400	A
		$T_{case} = 70\text{ }^\circ\text{C}$	300	A
I_{CRM}	$I_{CRM} = 2 \times I_{Cnom}$	600		A
V_{GES}		± 20		V
t_{psc}	$V_{CC} = 300\text{ V}$; $V_{GE} \leq 20\text{ V}$; $T_j = 125\text{ }^\circ\text{C}$ $V_{CES} < 600\text{ V}$	10		μs
Inverse Diode				
I_F	$T_j = 150\text{ }^\circ\text{C}$	$T_{case} = 25\text{ }^\circ\text{C}$	250	A
		$T_{case} = 80\text{ }^\circ\text{C}$	170	A
I_{FRM}	$I_{FRM} = 2 \times I_{Fnom}$	600		A
I_{FSM}	$t_p = 10\text{ ms}$; sin.	$T_j = 150\text{ }^\circ\text{C}$	1600	A
Freewheeling Diode				
I_F	$T_j = 150\text{ }^\circ\text{C}$	$T_c = 25\text{ }^\circ\text{C}$	400	A
		$T_c = 80\text{ }^\circ\text{C}$	270	A
I_{FRM}	$I_{FRM} = 2 \times I_{Fnom}$	800		A
I_{FSM}	$t_p = 10\text{ ms}$; sin.	$T_j = 150\text{ }^\circ\text{C}$	2800	A
Module				
$I_{t(RMS)}$		500		A
T_{vj}		- 40 ... + 150		$^\circ\text{C}$
T_{stg}		- 40 ... + 125		$^\circ\text{C}$
V_{isol}	AC, 1 min.	2500		V

Characteristics		$T_c = 25\text{ }^\circ\text{C}$, unless otherwise specified			
Symbol	Conditions	min.	typ.	max.	Units
IGBT					
$V_{GE(th)}$	$V_{GE} = V_{CE}$, $I_C = 6\text{ mA}$	4,5	5,5	6,5	V
I_{CES}	$V_{GE} = 0\text{ V}$, $V_{CE} = V_{CES}$		$T_j = 25\text{ }^\circ\text{C}$ 0,2	0,6	mA
V_{CE0}		$T_j = 25\text{ }^\circ\text{C}$	1,05		V
		$T_j = 125\text{ }^\circ\text{C}$	1		V
r_{CE}	$V_{GE} = 15\text{ V}$	$T_j = 25\text{ }^\circ\text{C}$	3,2		$\text{m}\Omega$
		$T_j = 125\text{ }^\circ\text{C}$	4,7		$\text{m}\Omega$
$V_{CE(sat)}$	$I_{Cnom} = 300\text{ A}$, $V_{GE} = 15\text{ V}$	$T_j = 25\text{ }^\circ\text{C}_{chiplev.}$	2,1	2,5	V
		$T_j = 125\text{ }^\circ\text{C}_{chiplev.}$	2,4	2,8	V
C_{ies}	$V_{CE} = 25$, $V_{GE} = 0\text{ V}$	$f = 1\text{ MHz}$	17		nF
C_{oes}			2		nF
C_{res}			1,2		nF
Q_G	$V_{GE} = 0\text{ V} \dots 15\text{ V}$	720		nC	
R_{Gint}	$T_j = \text{ }^\circ\text{C}$	0		Ω	
$t_{d(on)}$	$R_{Gon} = 6\text{ }\Omega$	$V_{CC} = 300\text{ V}$ $I_C = 300\text{ A}$	160		ns
t_r			80		ns
E_{on}	$R_{Goff} = 6\text{ }\Omega$	$T_j = 125\text{ }^\circ\text{C}$ $V_{GE} = \pm 15\text{ V}$	14		mJ
$t_{d(off)}$			550		ns
t_f			50		ns
E_{off}			13		mJ
$R_{th(j-c)}$	per IGBT			0,09	K/W



SEMITRANS® 3

Superfast IGBT Modules

SKM 300GB063D

SKM 300GAR063D

SKM 300GAL063D

Features

- NPT- Non punch-through IGBT
- Low tail current with low temperature dependence
- High short circuit capability, self limiting if term. G is clamped to E
- Pos. temp.-coeff. of V_{CEsat}
- 50 % less turn off losses
- 30 % less short circuit current
- Very low C_{ies} , C_{oes} , C_{res}
- Latch-up free
- Fast & soft inverse CAL diodes
- Isolated copper baseplate using DCB Direct Copper Bonding Technology without hard mould
- Large clearance (13 mm) and creepage distances (20 mm)

Typical Applications

- Switching (not for linear use)
- Switched mode power supplies
- AC inverter servo drives
- UPS uninterruptable power supplies
- Welding inverters

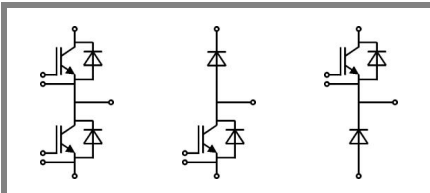

GB

GAL

GAR

Characteristics					
Symbol	Conditions	min.	typ.	max.	Units
Inverse Diode					
$V_F = V_{EC}$	$I_{Fnom} = 300\text{ A}; V_{GE} = 0\text{ V}$	$T_j = 25\text{ }^\circ\text{C}_{chiplev.}$	1,65	2	V
		$T_j = 125\text{ }^\circ\text{C}_{chiplev.}$	1,65	2	V
V_{F0}		$T_j = 125\text{ }^\circ\text{C}$		0,9	V
r_F		$T_j = 125\text{ }^\circ\text{C}$	3	3,7	mΩ
I_{RRM}	$I_F = 300\text{ A}$	$T_j = 125\text{ }^\circ\text{C}$	120		A
Q_{rr}			18		μC
E_{rr}	$V_{GE} = -15\text{ V}; V_{CC} = 300\text{ V}$				mJ
$R_{th(j-c)D}$	per diode			0,25	K/W
Freewheeling Diode					
$V_F = V_{EC}$	$I_{Fnom} = 400\text{ A}; V_{GE} = 0\text{ V}$	$T_j = 25\text{ }^\circ\text{C}_{chiplev.}$	1,65	2	V
		$T_j = 125\text{ }^\circ\text{C}_{chiplev.}$	1,65	2	V
V_{F0}		$T_j = 125\text{ }^\circ\text{C}$		0,9	V
r_F		$T_j = 125\text{ }^\circ\text{C}$		3	V
I_{RRM}	$I_F = 300\text{ A}$	$T_j = 125\text{ }^\circ\text{C}$	130		A
Q_{rr}			23		μC
E_{rr}	$V_{GE} = -15\text{ V}; V_{CC} = 300\text{ V}$				mJ
$R_{th(j-c)FD}$	per diode			0,15	K/W
Module					
L_{CE}			15	20	nH
$R_{CC+EE'}$	res., terminal-chip	$T_{case} = 25\text{ }^\circ\text{C}$	0,35		mΩ
		$T_{case} = 125\text{ }^\circ\text{C}$	0,5		mΩ
$R_{th(c-s)}$	per module			0,038	K/W
M_s	to heat sink M6		3	5	Nm
M_t	to terminals M6		2,5	5	Nm
w				325	g

This is an electrostatic discharge sensitive device (ESDS), international standard IEC 60747-1, Chapter IX.

This technical information specifies semiconductor devices but promises no characteristics. No warranty or guarantee expressed or implied is made regarding delivery, performance or suitability.

SKM 300GB063D

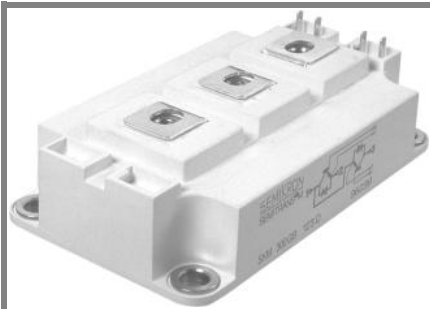

SEMITRANS® 3

Superfast IGBT Modules

SKM 300GB063D

SKM 300GAR063D

SKM 300GAL063D

Features

- NPT- Non punch-through IGBT
- Low tail current with low temperature dependence
- High short circuit capability, self limiting if term. G is clamped to E
- Pos. temp.-coeff. of V_{CEsat}
- 50 % less turn off losses
- 30 % less short circuit current
- Very low C_{ies} , C_{oes} , C_{res}
- Latch-up free
- Fast & soft inverse CAL diodes
- Isolated copper baseplate using DCB Direct Copper Bonding Technology without hard mould
- Large clearance (13 mm) and creepage distances (20 mm)

Typical Applications

- Switching (not for linear use)
- Switched mode power supplies
- AC inverter servo drives
- UPS uninterruptable power supplies
- Welding inverters

Z_{th}		Conditions	Values	Units
$Z_{th(j-c)I}$				
$R_{\theta j-c}$		i = 1	65	mk/W
$R_{\theta j-c}$		i = 2	19	mk/W
$R_{\theta j-c}$		i = 3	4,7	mk/W
$R_{\theta j-c}$		i = 4	1,3	mk/W
$\tau_{th(j-c)}$		i = 1	0,0518	s
$\tau_{th(j-c)}$		i = 2	0,0241	s
$\tau_{th(j-c)}$		i = 3	0,0021	s
$\tau_{th(j-c)}$		i = 4	0,0001	s
$Z_{th(j-c)D}$				
$R_{\theta j-cD}$		i = 1	140	mk/W
$R_{\theta j-cD}$		i = 2	85	mk/W
$R_{\theta j-cD}$		i = 3	20,55	mk/W
$R_{\theta j-cD}$		i = 4	4,45	mk/W
$\tau_{th(j-c)D}$		i = 1	0,0613	s
$\tau_{th(j-c)D}$		i = 2	0,0041	s
$\tau_{th(j-c)D}$		i = 3	0,0045	s
$\tau_{th(j-c)D}$		i = 4	0,0003	s

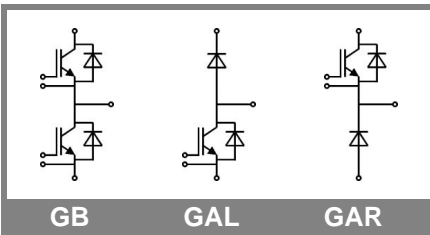

GB

GAL

GAR

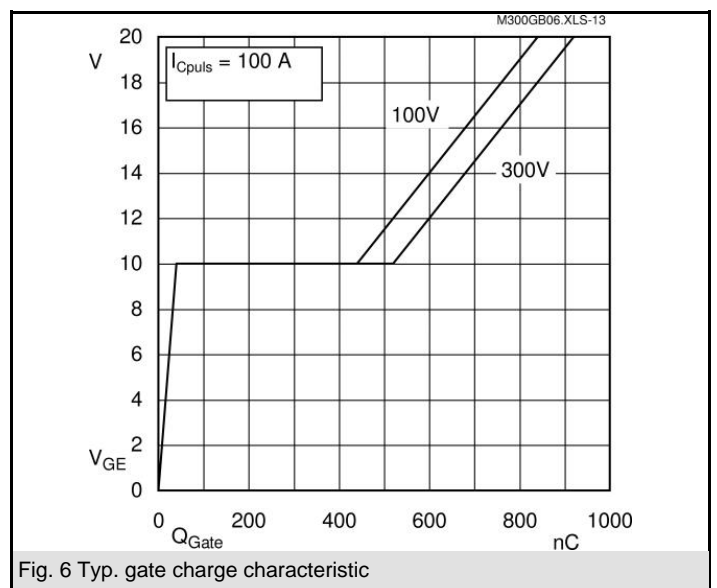
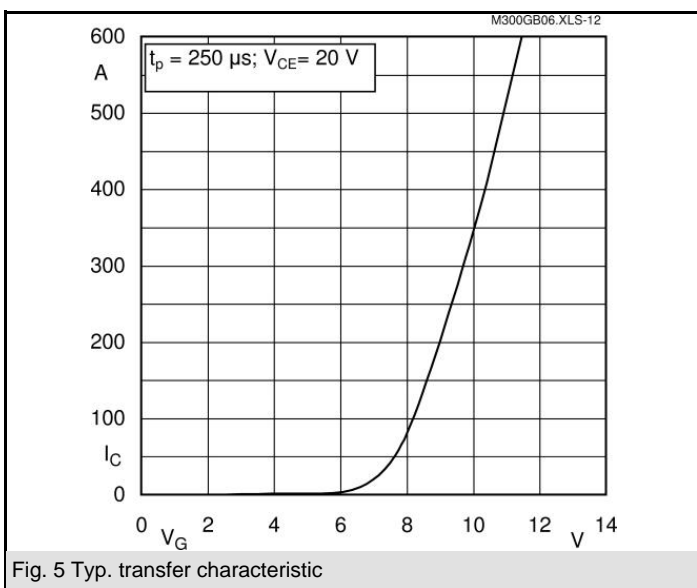
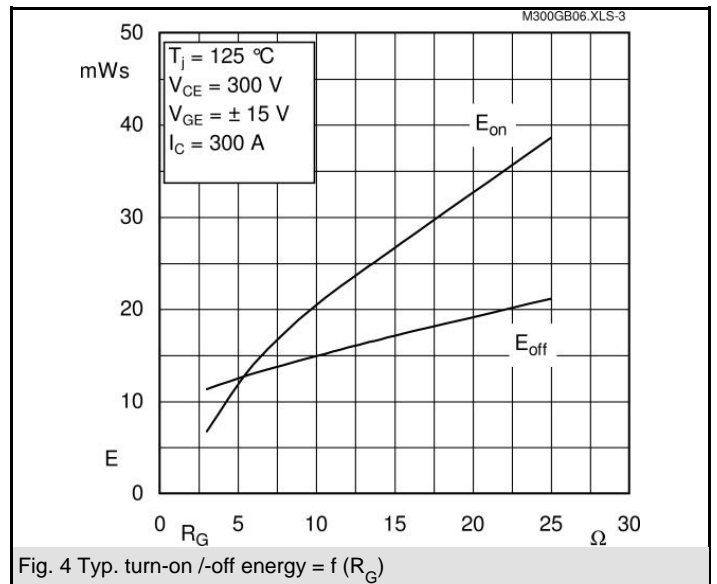
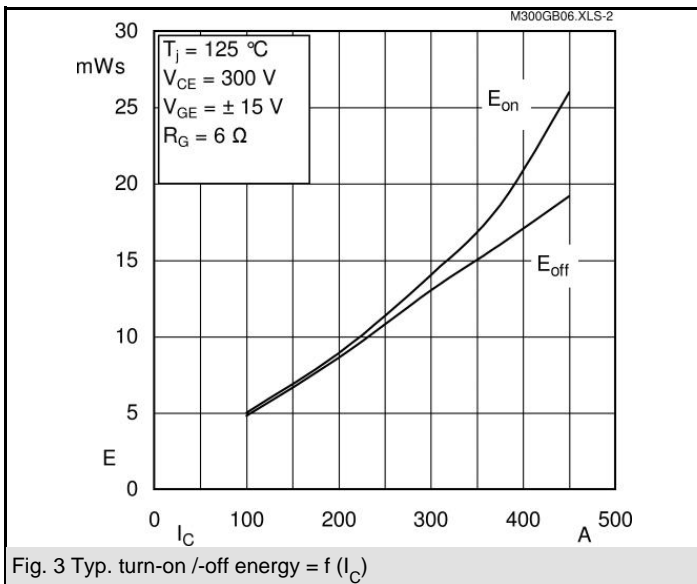
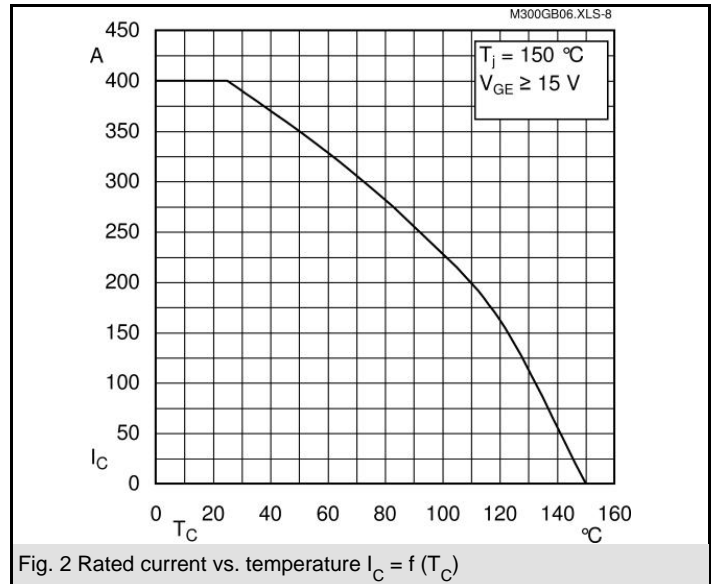
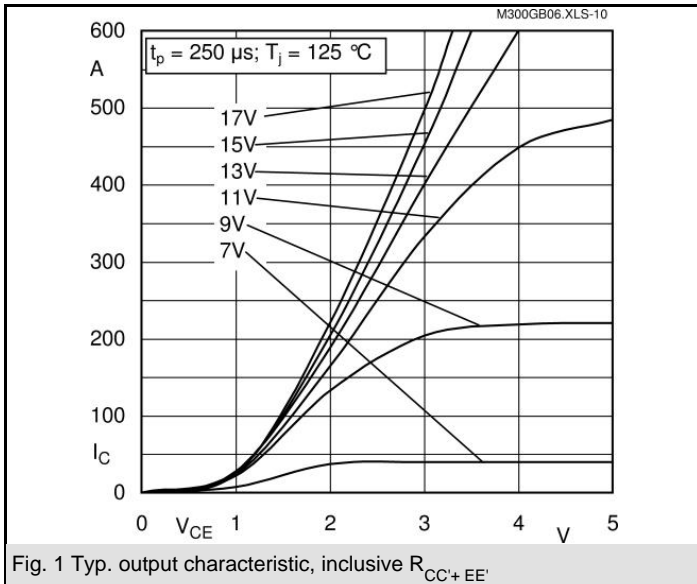

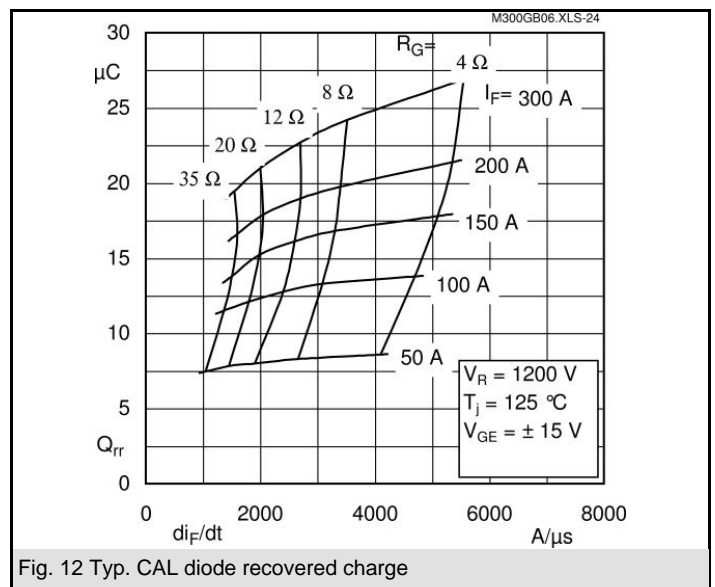
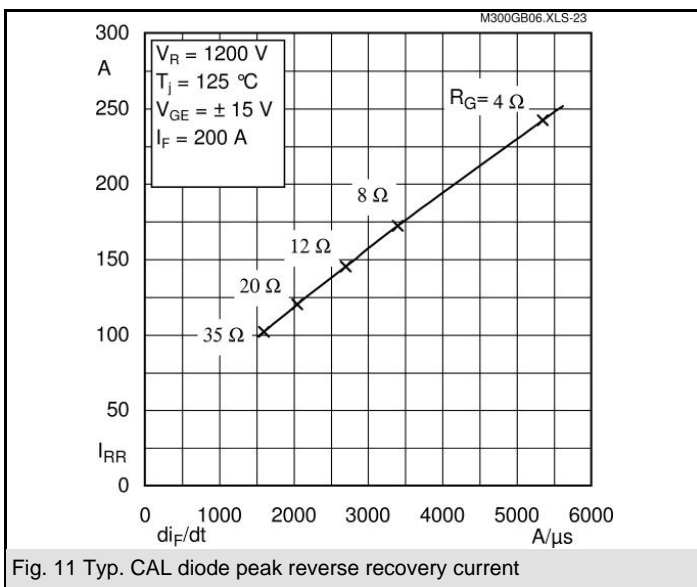
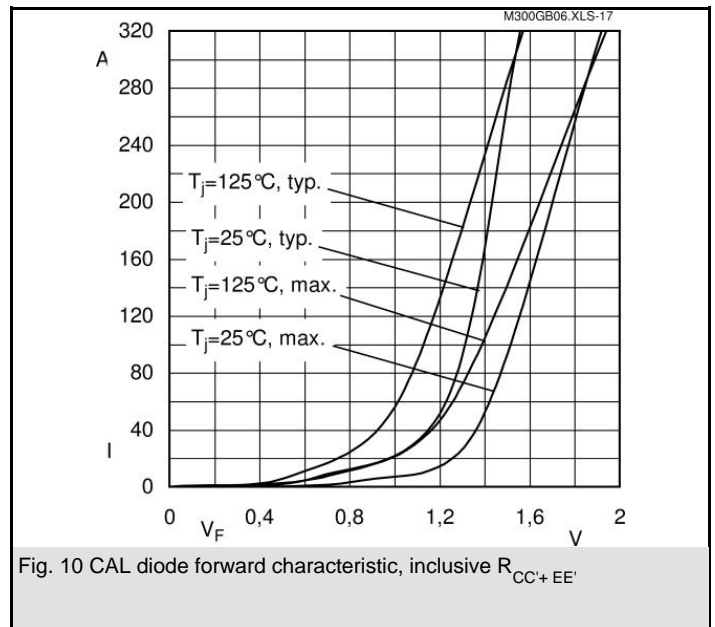
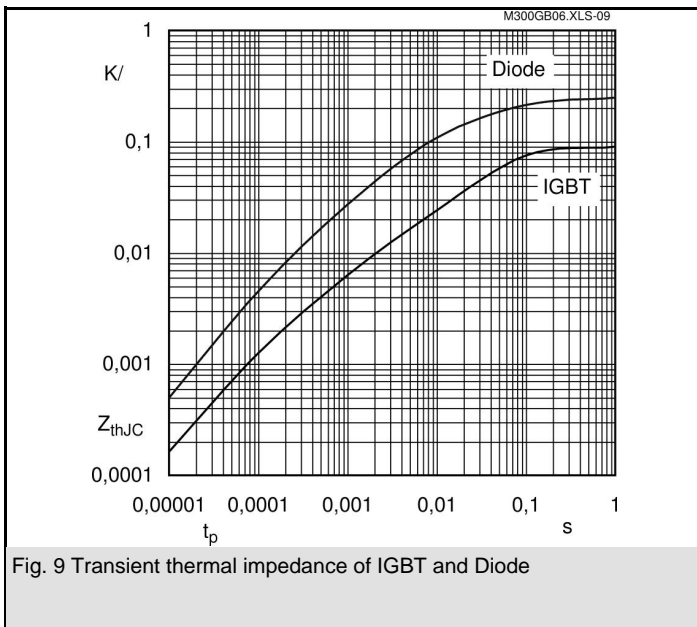
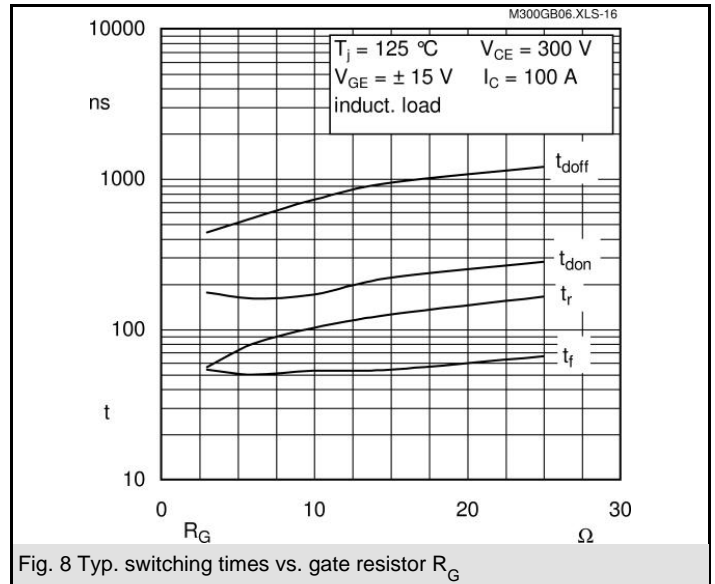
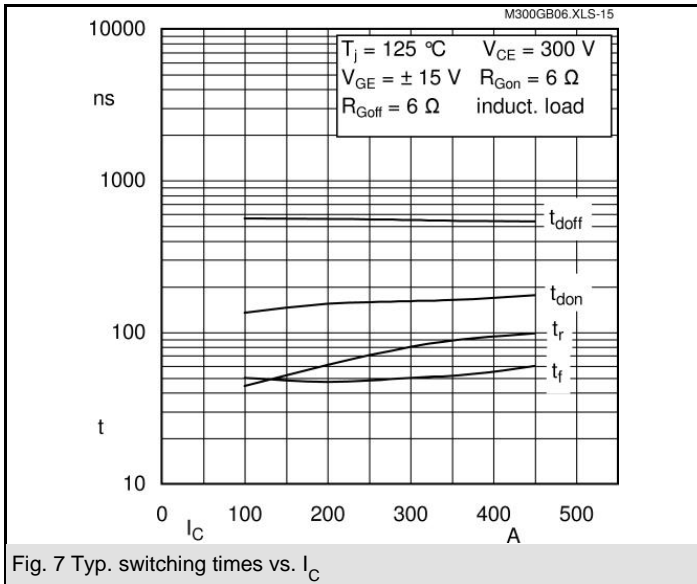

SKM 300GB063D

UL Recognized

CASED56

File no. E 63 532

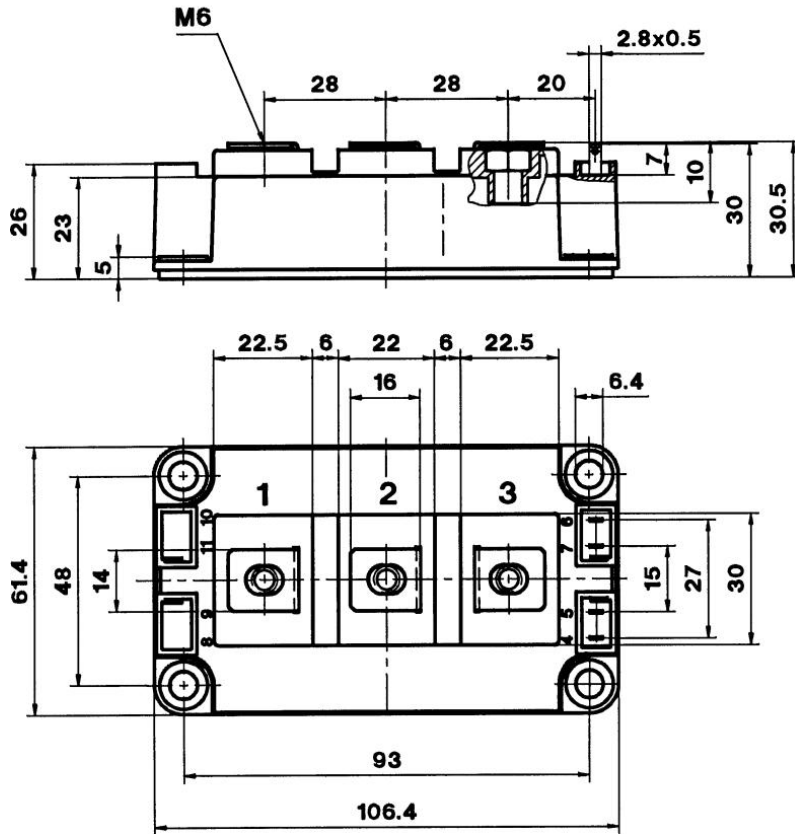

Case D 56

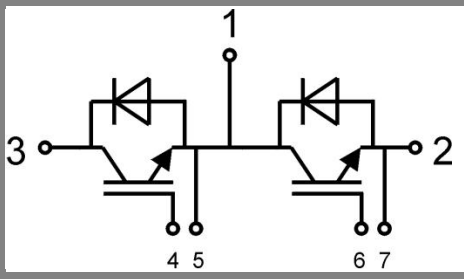

GB

Case D 56



GAL

Case D 57 (→ D 56)

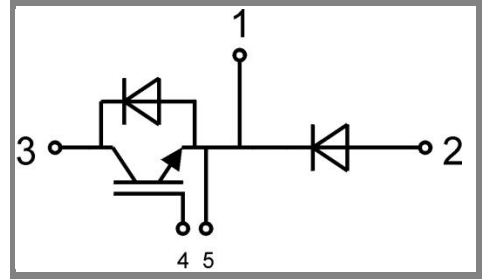

GAR

Case D 58 (→ D 56)