

SKM300GAL12T4



SEMITRANS®3

Fast IGBT4 Modules

SKM300GAL12T4

Features

- $V_{CE(sat)}$ with positive temperature coefficient
- High short circuit capability, self limiting to 6 x I_{Cnom}
- Fast & soft inverse CAL diodes
- Large clearance (10 mm) and creepage distances (20 mm)
- Isolated copper baseplate using DBC Technology (Direct Copper Bonding)

Typical Applications

- DC/DC – converter
- Brake chopper
- Switched reluctance motor
- DC – motor

Remarks

- Case temperature limited to $T_c = 125^\circ\text{C}$ max, recomm. $T_{op} = -40 \dots +150^\circ\text{C}$, product rel. results valid for $T_j = 150^\circ$

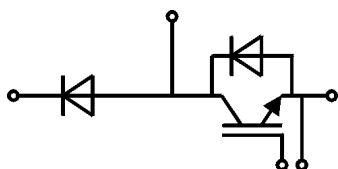

GAL

Absolute Maximum Ratings					
Symbol	Conditions		Values	Unit	
IGBT					
V_{CES}			1200	V	
I_C	$T_j = 175^\circ\text{C}$	$T_c = 25^\circ\text{C}$	422	A	
		$T_c = 80^\circ\text{C}$	324	A	
I_{Cnom}			300	A	
I_{CRM}	$I_{CRM} = 3 \times I_{Cnom}$		900	A	
V_{GES}			-20 ... 20	V	
t_{psc}	$V_{CC} = 800\text{ V}$ $V_{GE} \leq 15\text{ V}$ $V_{CES} \leq 1200\text{ V}$	$T_j = 150^\circ\text{C}$	10		μs
T_j			-40 ... 175	$^\circ\text{C}$	
Inverse diode					
I_F	$T_j = 175^\circ\text{C}$	$T_c = 25^\circ\text{C}$	353	A	
		$T_c = 80^\circ\text{C}$	264	A	
I_{Fnom}			300	A	
I_{FRM}	$I_{FRM} = 3 \times I_{Fnom}$		900	A	
I_{FSM}	$t_p = 10\text{ ms, sin } 180^\circ, T_j = 25^\circ\text{C}$		1548	A	
T_j			-40 ... 175	$^\circ\text{C}$	
Freewheeling diode					
I_F	$T_j = 175^\circ\text{C}$	$T_c = 25^\circ\text{C}$	353	A	
		$T_c = 80^\circ\text{C}$	264	A	
I_{Fnom}			300	A	
I_{FRM}	$I_{FRM} = 3 \times I_{Fnom}$		900	A	
I_{FSM}	$t_p = 10\text{ ms, sin } 180^\circ, T_j = 25^\circ\text{C}$		1548	A	
T_j			-40 ... 175	$^\circ\text{C}$	
Module					
$I_{t(RMS)}$			500	A	
T_{stg}			-40 ... 125	$^\circ\text{C}$	
V_{isol}	AC sinus 50Hz, $t = 1\text{ min}$		4000	V	

Characteristics						
Symbol	Conditions		min.	typ.	max.	Unit
IGBT						
$V_{CE(sat)}$	$I_C = 300\text{ A}$ $V_{GE} = 15\text{ V}$ chipelevel	$T_j = 25^\circ\text{C}$	1.85	2.1		V
		$T_j = 150^\circ\text{C}$	2.25	2.45		V
V_{CE0}		$T_j = 25^\circ\text{C}$	0.8	0.9		V
		$T_j = 150^\circ\text{C}$	0.7	0.8		V
r_{CE}	$V_{GE} = 15\text{ V}$	$T_j = 25^\circ\text{C}$	3.5	4.0		$\text{m}\Omega$
		$T_j = 150^\circ\text{C}$	5.2	5.5		$\text{m}\Omega$
$V_{GE(th)}$	$V_{GE} = V_{CE}, I_C = 12\text{ mA}$		5	5.8	6.5	V
I_{CES}	$V_{GE} = 0\text{ V}$ $V_{CE} = 1200\text{ V}$	$T_j = 25^\circ\text{C}$	0.1	0.3		mA
		$T_j = 150^\circ\text{C}$				mA
C_{ies}	$V_{CE} = 25\text{ V}$ $V_{GE} = 0\text{ V}$	$f = 1\text{ MHz}$	17.6			nF
C_{oes}		$f = 1\text{ MHz}$	1.16			nF
C_{res}		$f = 1\text{ MHz}$	0.94			nF
Q_G	$V_{GE} = -8\text{ V} \dots +15\text{ V}$		1700			nC
R_{Gint}	$T_j = 25^\circ\text{C}$		2.5			Ω



SEMITRANS®3

Fast IGBT4 Modules

SKM300GAL12T4

Features

- $V_{CE(sat)}$ with positive temperature coefficient
- High short circuit capability, self limiting to 6 x I_{cnom}
- Fast & soft inverse CAL diodes
- Large clearance (10 mm) and creepage distances (20 mm)
- Isolated copper baseplate using DBC Technology (Direct Copper Bonding)

Typical Applications

- DC/DC – converter
- Brake chopper
- Switched reluctance motor
- DC – motor

Remarks

- Case temperature limited to $T_c = 125^\circ\text{C}$ max, recomm. $T_{op} = -40 \dots +150^\circ\text{C}$, product rel. results valid for $T_j = 150^\circ$

Characteristics						
Symbol	Conditions		min.	typ.	max.	Unit
$t_{d(on)}$	$V_{CC} = 600\text{ V}$	$T_j = 150^\circ\text{C}$		200		ns
t_r	$I_C = 300\text{ A}$	$T_j = 150^\circ\text{C}$		44		ns
E_{on}	$V_{GE} = \pm 15\text{ V}$	$T_j = 150^\circ\text{C}$		27		mJ
$t_{d(off)}$	$R_{G\ on} = 1.5\ \Omega$	$T_j = 150^\circ\text{C}$		450		ns
t_f	$R_{G\ off} = 1.5\ \Omega$	$T_j = 150^\circ\text{C}$		90		ns
E_{off}	$di/dt_{on} = 7500\text{ A}/\mu\text{s}$	$T_j = 150^\circ\text{C}$		29		mJ
$R_{th(j-c)}$	per IGBT				0.11	K/W
Inverse diode						
$V_F = V_{EC}$	$I_F = 300\text{ A}$	$T_j = 25^\circ\text{C}$		2.17	2.49	V
	$V_{GE} = 0\text{ V}$	$T_j = 150^\circ\text{C}$		2.11	2.42	V
	chip					
V_{F0}		$T_j = 25^\circ\text{C}$		1.3	1.5	V
		$T_j = 150^\circ\text{C}$		0.9	1.1	V
r_F		$T_j = 25^\circ\text{C}$		2.9	3.3	m Ω
		$T_j = 150^\circ\text{C}$		4.0	4.4	m Ω
I_{RRM}	$I_F = 300\text{ A}$	$T_j = 150^\circ\text{C}$		345		A
Q_{rr}	$di/dt_{off} = 7300\text{ A}/\mu\text{s}$	$T_j = 150^\circ\text{C}$		54		μC
E_{rr}	$V_{GE} = \pm 15\text{ V}$	$T_j = 150^\circ\text{C}$		23		mJ
	$V_{CC} = 600\text{ V}$					
$R_{th(j-c)}$	per diode				0.17	K/W
Freewheeling diode						
$V_F = V_{EC}$	$I_F = 300\text{ A}$	$T_j = 25^\circ\text{C}$		2.17	2.49	V
	$V_{GE} = 0\text{ V}$	$T_j = 150^\circ\text{C}$		2.11	2.42	V
	chip					
V_{F0}		$T_j = 25^\circ\text{C}$		1.3	1.5	V
		$T_j = 150^\circ\text{C}$		0.9	1.1	V
r_F		$T_j = 25^\circ\text{C}$		2.9	3.3	m Ω
		$T_j = 150^\circ\text{C}$		4.0	4.4	m Ω
I_{RRM}	$I_F = 300\text{ A}$	$T_j = 150^\circ\text{C}$		345		A
Q_{rr}	$di/dt_{off} = 7300\text{ A}/\mu\text{s}$	$T_j = 150^\circ\text{C}$		54		μC
E_{rr}	$V_{GE} = \pm 15\text{ V}$	$T_j = 150^\circ\text{C}$		23		mJ
	$V_{CC} = 600\text{ V}$					
$R_{th(j-c)}$	per Diode				0.17	K/W
Module						
L_{CE}				15	20	nH
$R_{CC'+EE'}$	terminal-chip	$T_c = 25^\circ\text{C}$		0.25		m Ω
		$T_c = 125^\circ\text{C}$		0.5		m Ω
$R_{th(c-s)}$	per module			0.02	0.038	K/W
M_s	to heat sink M6			3	5	Nm
M_t		to terminals M6		2.5	5	Nm
						Nm
w					325	g

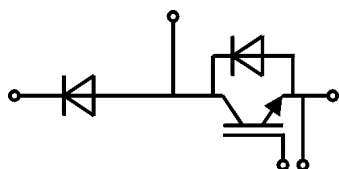

GAL

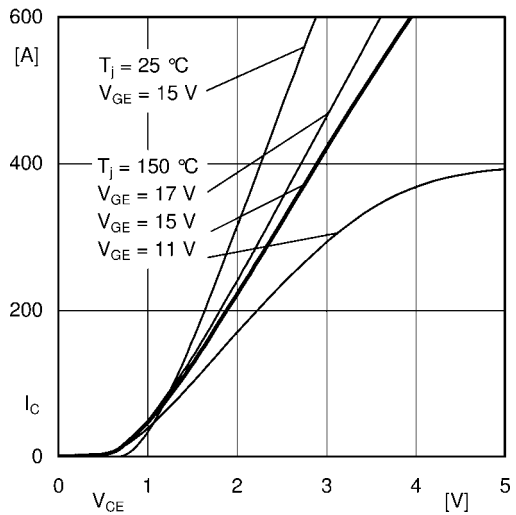

Fig. 1: Typ. output characteristic, inclusive $R_{CC'+EE'}$

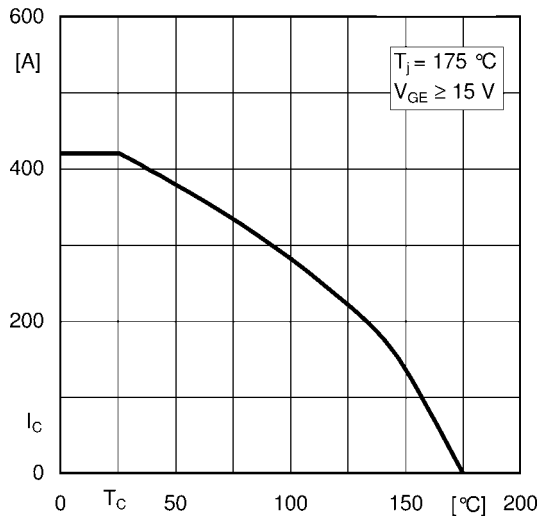

Fig. 2: Rated current vs. temperature $I_C = f(T_C)$

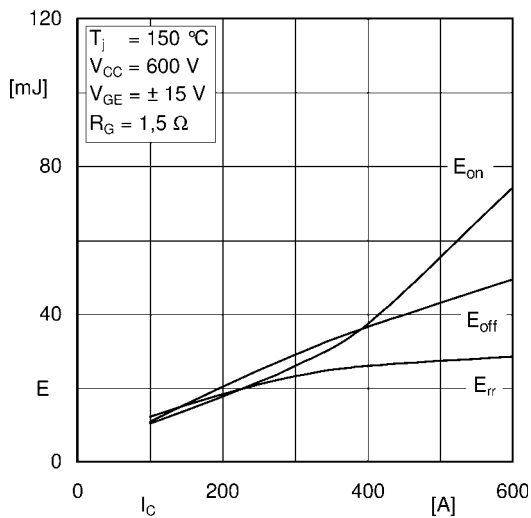

Fig. 3: Typ. turn-on /-off energy = $f(I_C)$

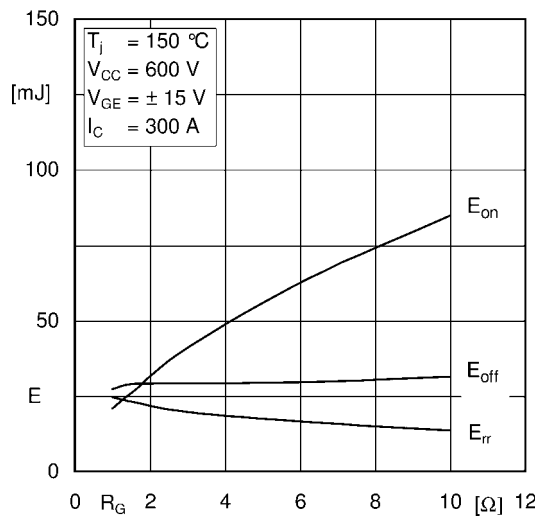

Fig. 4: Typ. turn-on /-off energy = $f(R_G)$

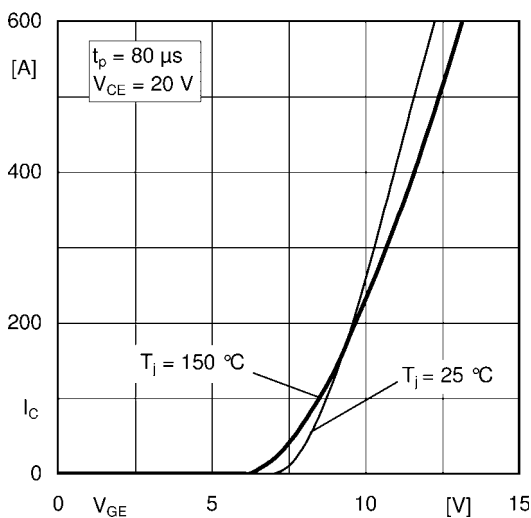

Fig. 5: Typ. transfer characteristic

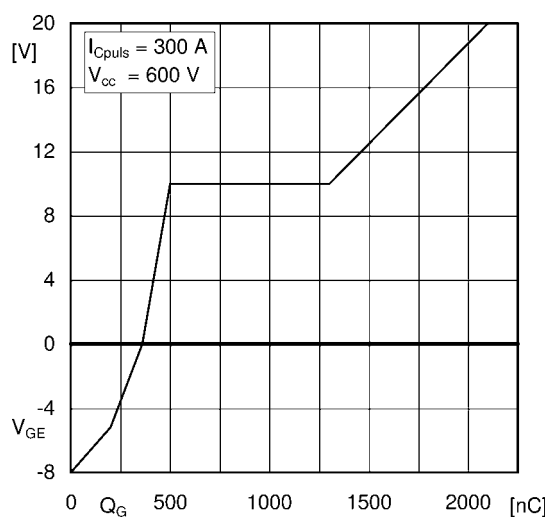

Fig. 6: Typ. gate charge characteristic

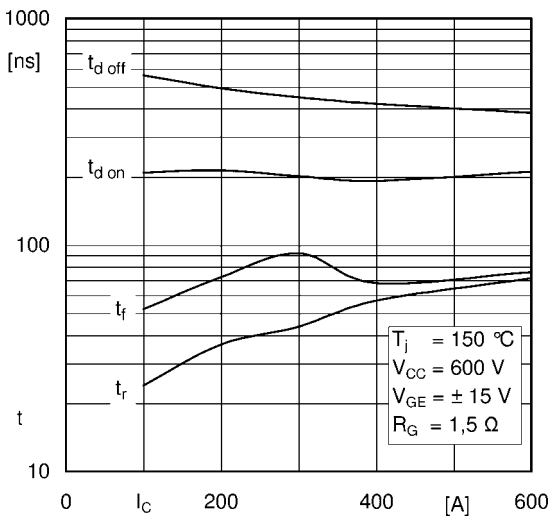

Fig. 7: Typ. switching times vs. I_C

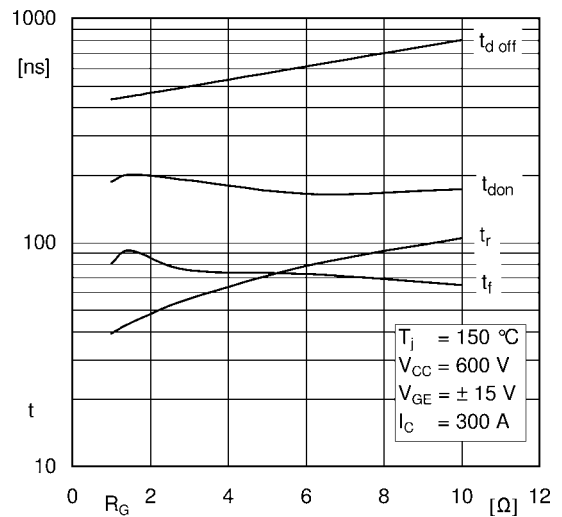

Fig. 8: Typ. switching times vs. gate resistor R_G

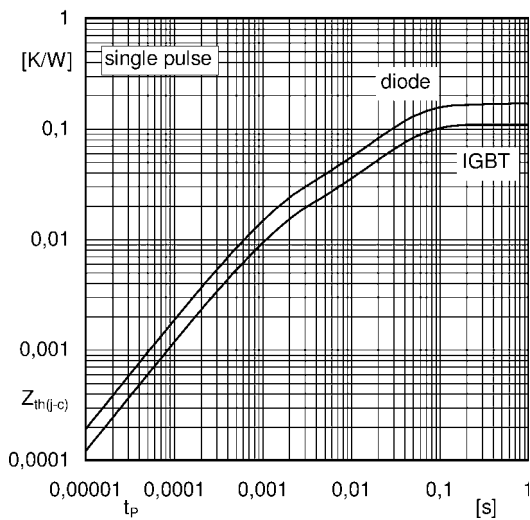

Fig. 9: Transient thermal impedance

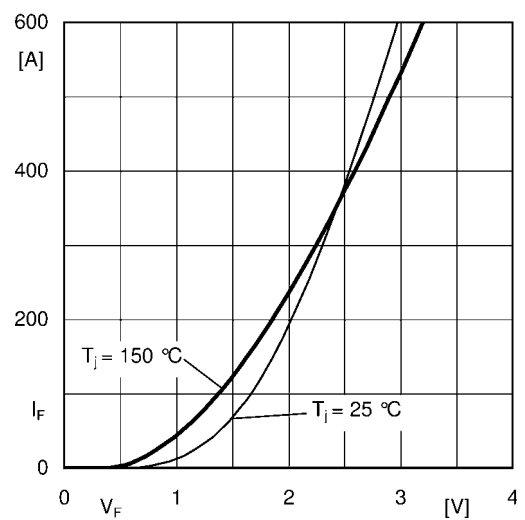

Fig. 10: CAL diode forward characteristic

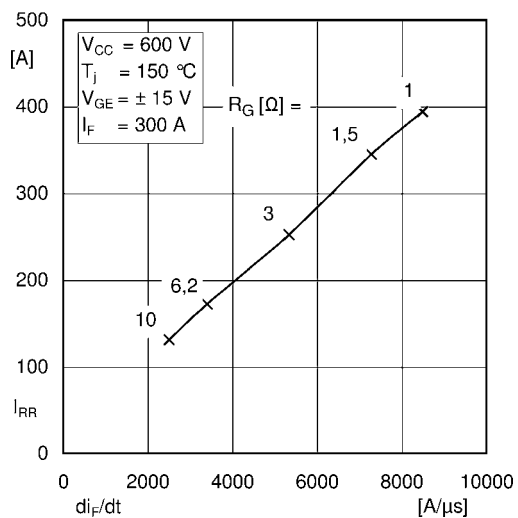

Fig. 11: CAL diode peak reverse recovery current

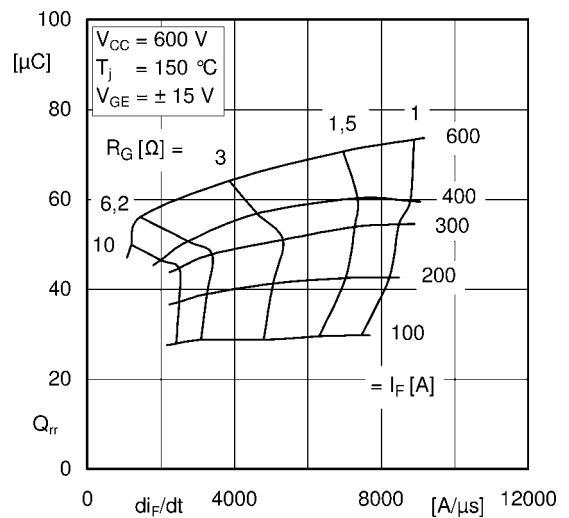
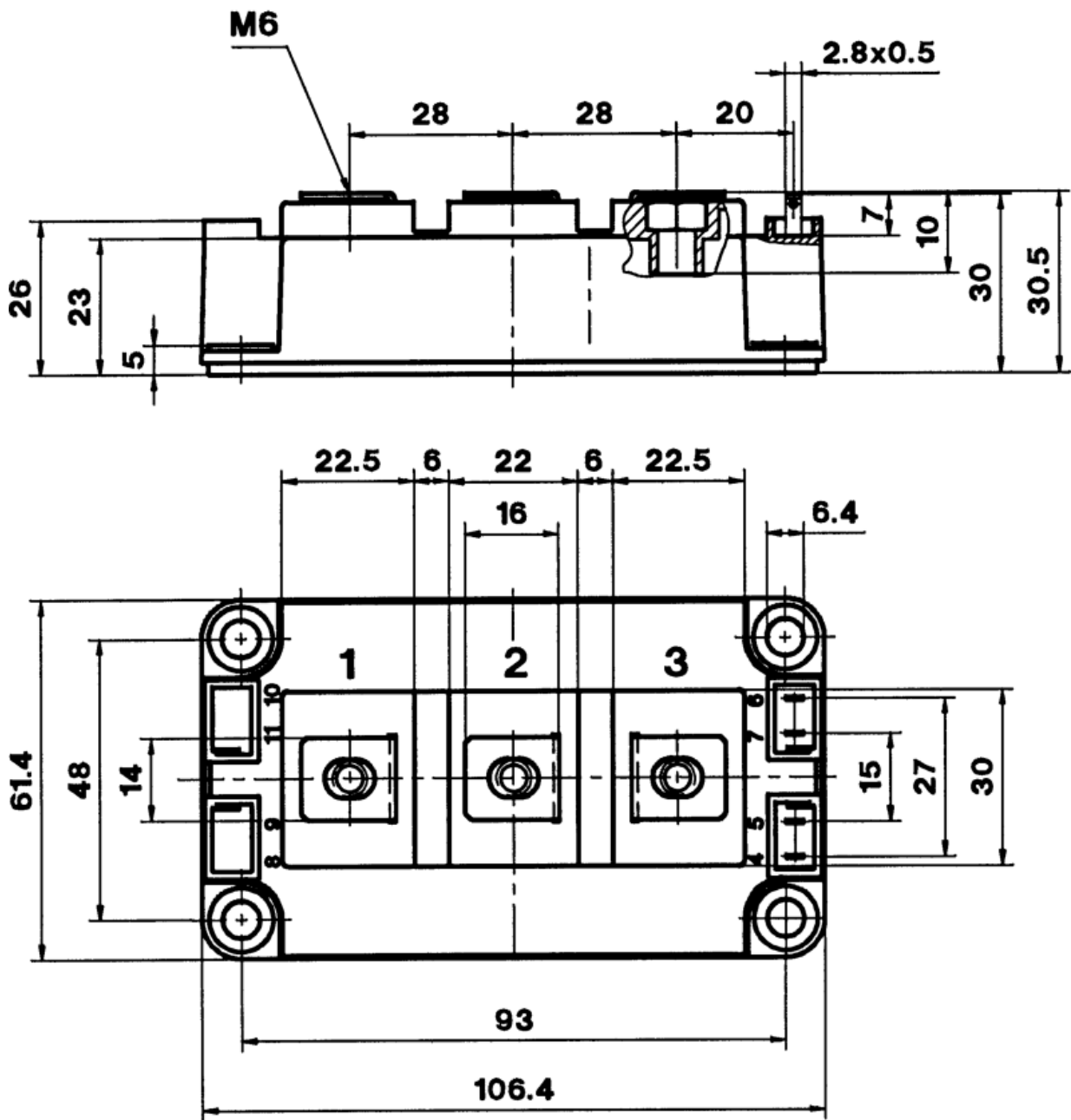
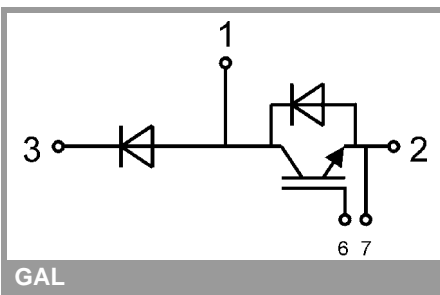

Fig. 12: Typ. CAL diode peak reverse recovery charge



Semitrans 3



This is an electrostatic discharge sensitive device (ESDS), international standard IEC 60747-1, Chapter IX.

This technical information specifies semiconductor devices but promises no characteristics. No warranty or guarantee expressed or implied is made regarding delivery, performance or suitability.