

SKM 145GB174DN



SEMITRANS™ 2N

Low Loss IGBT Modules

SKM 145GB174DN

SKM 145GAL174DN

Features

- N channel, homogeneous Silicon structure (NPT- Non punch-through IGBT)
- Low inductance case
- High short circuit capability, self limiting
- Fast & soft inverse CAL diodes
- Without hard mould
- Large clearance (10 mm) and creepage distances (20 mm)

Typical Applications

- AC inverter drives on mains
- 575 - 750 V AC
- DC bus voltage 750 - 1200 V_{DC}
- Public transport (auxiliary syst.)
- Switching (not for linear use)

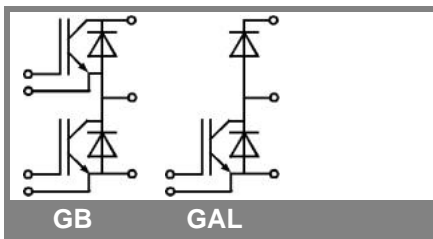

Absolute Maximum Ratings		$T_c = 25\text{ }^\circ\text{C}$, unless otherwise specified	
Symbol	Conditions	Values	Units
IGBT			
V_{CES}		1700	V
I_C	$T_c = 25\text{ (80) }^\circ\text{C}$	160 (110)	A
I_{CRM}	$t_p = 1\text{ ms}$	200	A
V_{GES}		± 20	V
T_{vj} (T_{stg})	$T_{OPERATION} \leq T_{stg}$	- 40 ... + 150 (125)	$^\circ\text{C}$
V_{isol}	AC, 1 min.	3400	V
Inverse diode			
I_F	$T_c = 25\text{ (80) }^\circ\text{C}$	145 (100)	A
I_{FRM}	$t_p = 1\text{ ms}$	200	A
I_{FSM}	$t_p = 10\text{ ms}$; sin.; $T_j = 150\text{ }^\circ\text{C}$	720	A
Freewheeling diode			
I_F	$T_c = 25\text{ (80) }^\circ\text{C}$	145 (100)	A
I_{FRM}	$t_p = 1\text{ ms}$	200	A
I_{FSM}	$t_p = 10\text{ ms}$; sin.; $T_j = 150\text{ }^\circ\text{C}$	720	A

Characteristics		$T_c = 25\text{ }^\circ\text{C}$, unless otherwise specified			
Symbol	Conditions	min.	typ.	max.	Units
IGBT					
$V_{GE(th)}$	$V_{GE} = V_{CE}$, $I_C = 5\text{ mA}$	4,5	5,5	6,5	V
I_{CES}	$V_{GE} = 0$, $V_{CE} = V_{CES}$, $T_j = 25\text{ (125) }^\circ\text{C}$		0,1	0,3	mA
$V_{CE(TO)}$	$T_j = 25\text{ (125) }^\circ\text{C}$				V
r_{CE}	$V_{GE} = 15\text{ V}$, $T_j = 25\text{ (125) }^\circ\text{C}$				m Ω
$V_{CE(sat)}$	$I_{Cnom} = 100\text{ A}$, $V_{GE} = 15\text{ V}$, chip level		2,6 (3,2)	3,3 (3,6)	V
C_{ies}	under following conditions		7	8,5	nF
C_{oes}	$V_{GE} = 0$, $V_{CE} = 25\text{ V}$, $f = 1\text{ MHz}$		1,1	1,5	nF
C_{res}			0,4	0,6	nF
L_{CE}				25	nH
$R_{CC'+EE'}$	res., terminal-chip $T_c = 25\text{ (125) }^\circ\text{C}$		0,75 (1)		m Ω
$t_{d(on)}$	$V_{CC} = 1200\text{ V}$, $I_{Cnom} = 100\text{ A}$		90		ns
t_r	$R_{Gon} = R_{Goff} = 15\text{ }^\circ\Omega$, $T_j = 125\text{ }^\circ\text{C}$		80		ns
$t_{d(off)}$	$V_{GE} = \pm 15\text{ V}$		900		ns
t_f			80		ns
$E_{on} (E_{off})$			50 (70)		mJ
Inverse diode					
$V_F = V_{EC}$	$I_{Fnom} = 100\text{ A}$; $V_{GE} = 0\text{ V}$; $T_j = 25\text{ (125) }^\circ\text{C}$		2,2 (1,9)	2,7 (2,4)	V
$V_{(TO)}$	$T_j = 25\text{ (125) }^\circ\text{C}$		1,3	1,5	V
r_T	$T_j = 25\text{ (125) }^\circ\text{C}$		9	12	m Ω
I_{RRM}	$I_{Fnom} = 100\text{ A}$; $T_j = 125\text{ () }^\circ\text{C}$		160		A
Q_{rr}	$di/dt = 2400\text{ A}/\mu\text{s}$		32		μC
E_{rr}	$V_{GE} = 0\text{ V}$		14		mJ
FWD					
$V_F = V_{EC}$	$I_F = 100\text{ A}$; $V_{GE} = 0\text{ V}$, $T_j = 25\text{ (125) }^\circ\text{C}$		2,2 (1,9)	2,7 (2,4)	V
$V_{(TO)}$	$T_j = 25\text{ (125) }^\circ\text{C}$		1,3	1,5	V
r_T	$T_j = 25\text{ (125) }^\circ\text{C}$		9	12	m Ω
I_{RRM}	$I_F = 100\text{ A}$; $T_j = 125\text{ () }^\circ\text{C}$		160		A
Q_{rr}	$di/dt = 2400\text{ A}/\mu\text{s}$		32		μC
E_{rr}	$V_{GE} = 0\text{ V}$		14		mJ
Thermal characteristics					
$R_{th(j-c)}$	per IGBT			0,16	K/W
$R_{th(j-c)D}$	per Inverse Diode			0,3	K/W
$R_{th(j-c)FD}$	per FWD			0,3	K/W
$R_{th(c-s)}$	per module			0,05	K/W
Mechanical data					
M_s	to heatsink M6	3		5	Nm
M_t	to terminals M5	2,5		5	Nm
w				160	g

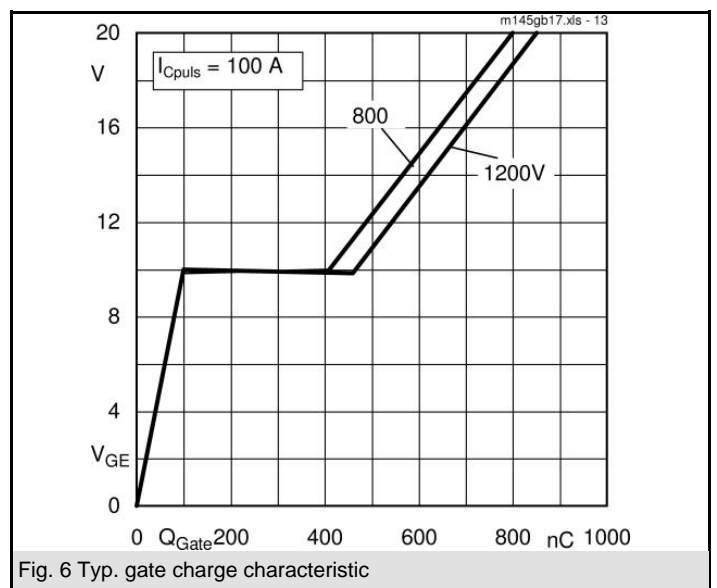
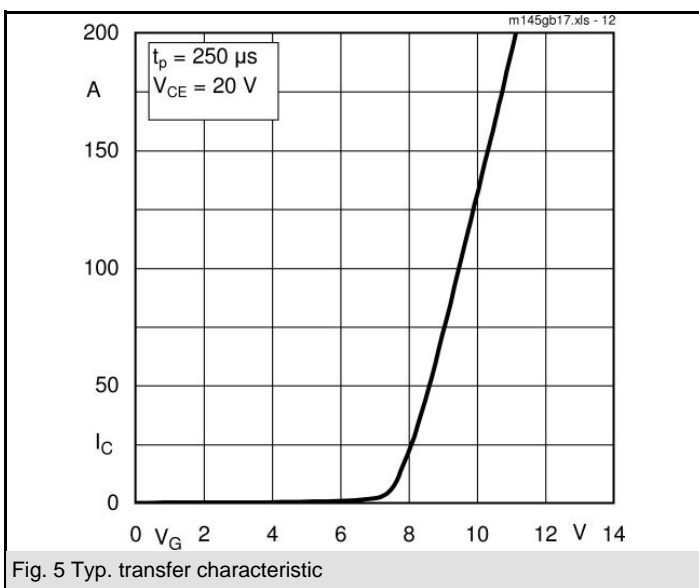
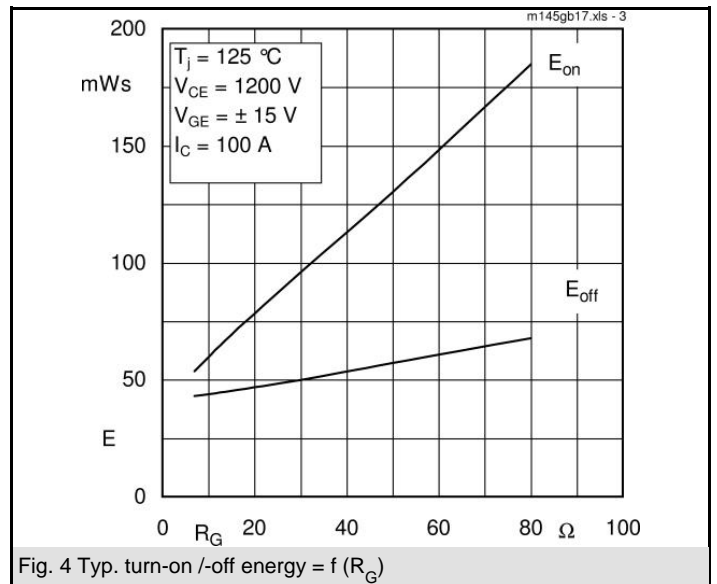
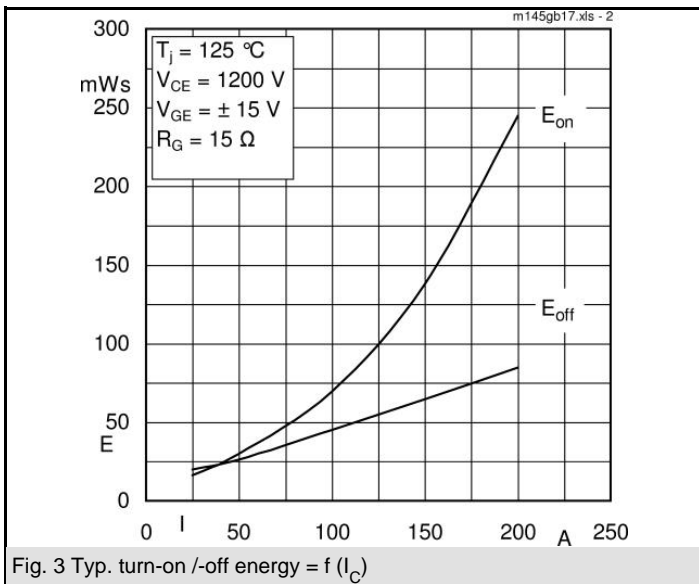
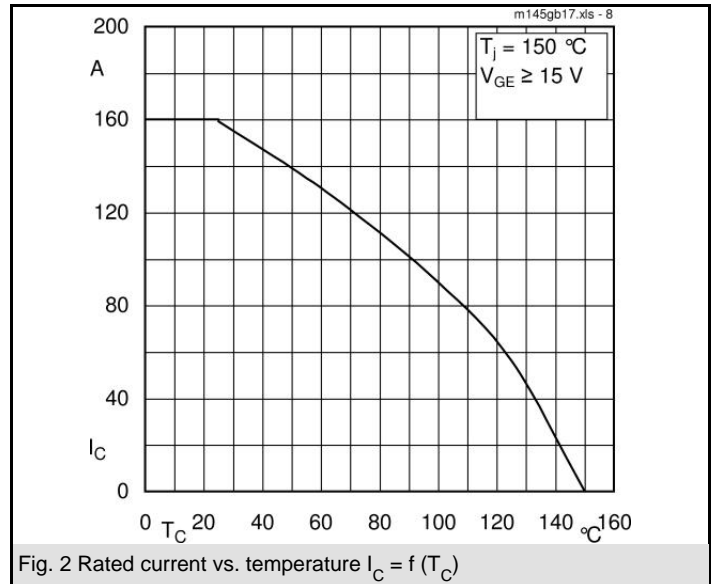
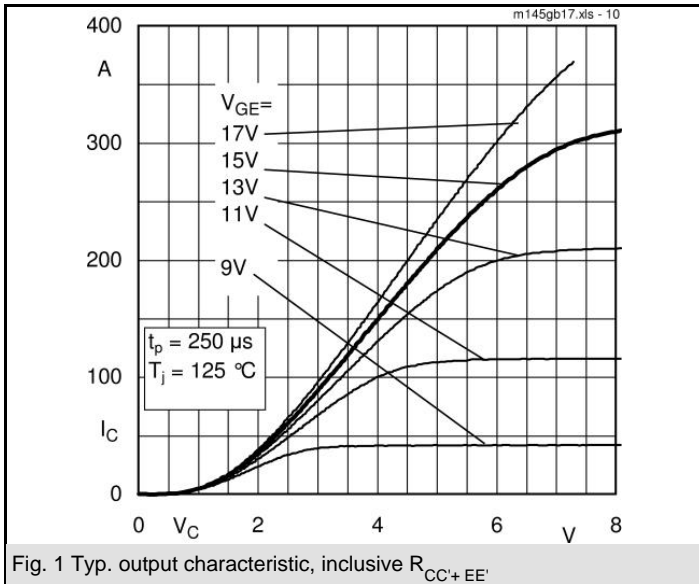

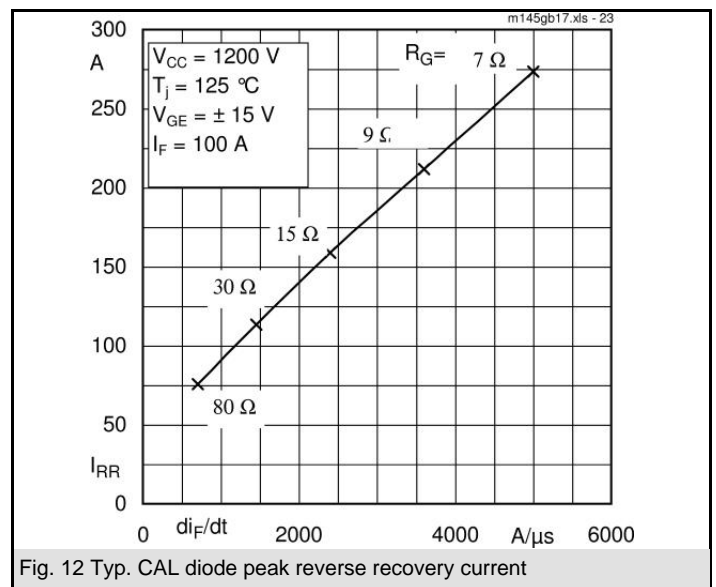
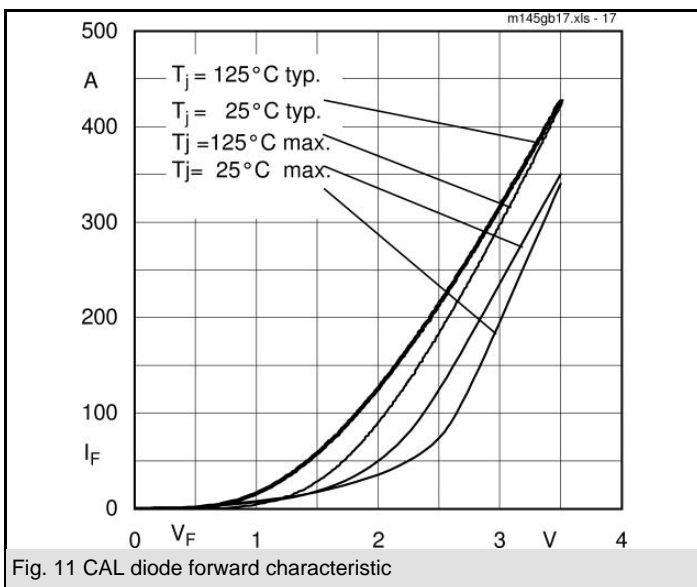
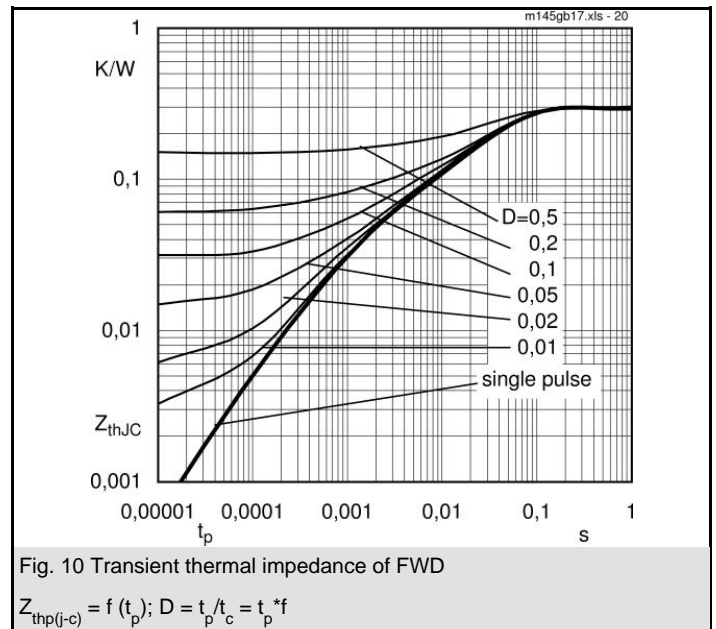
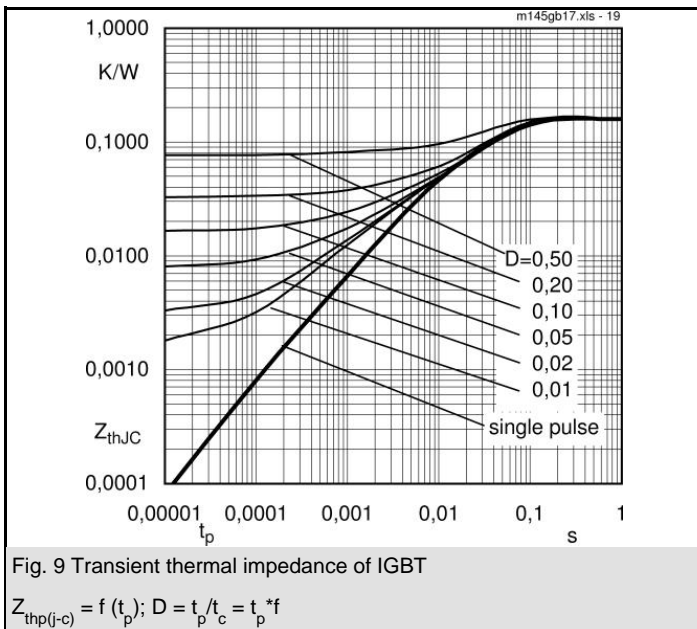
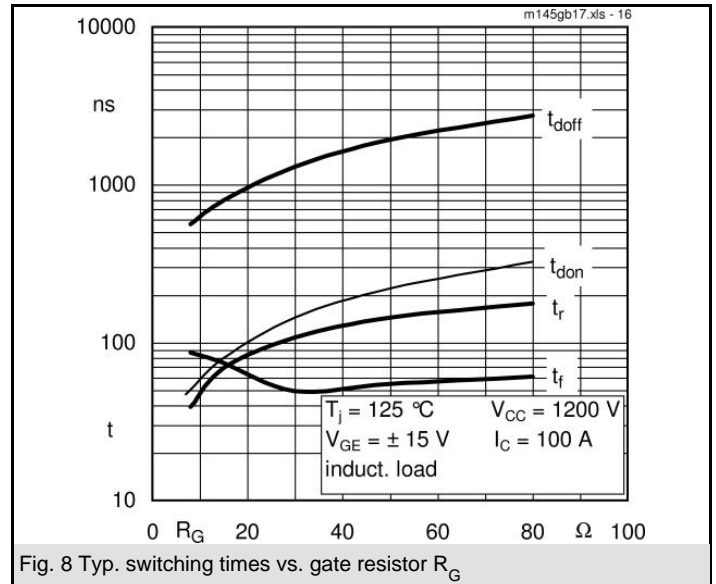
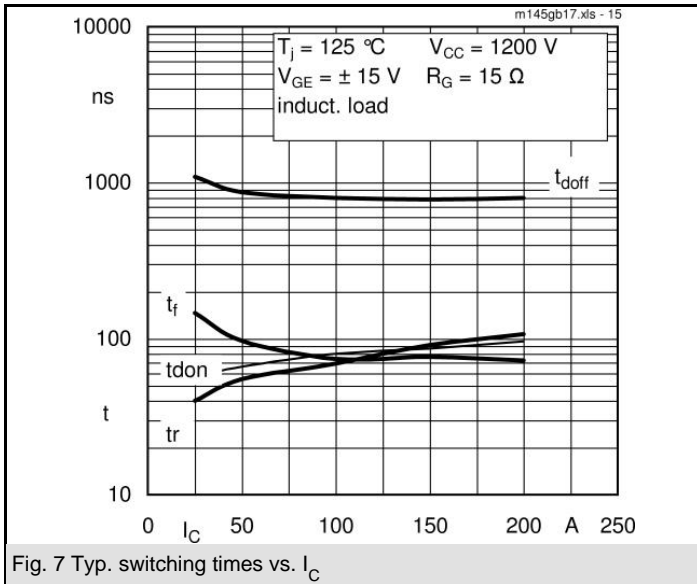

SKM 145GB174DN

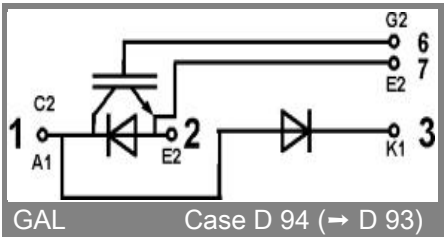
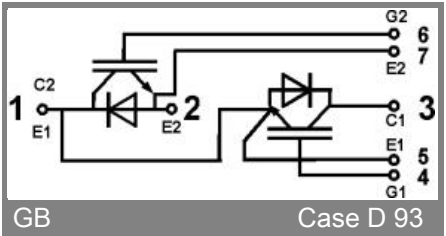
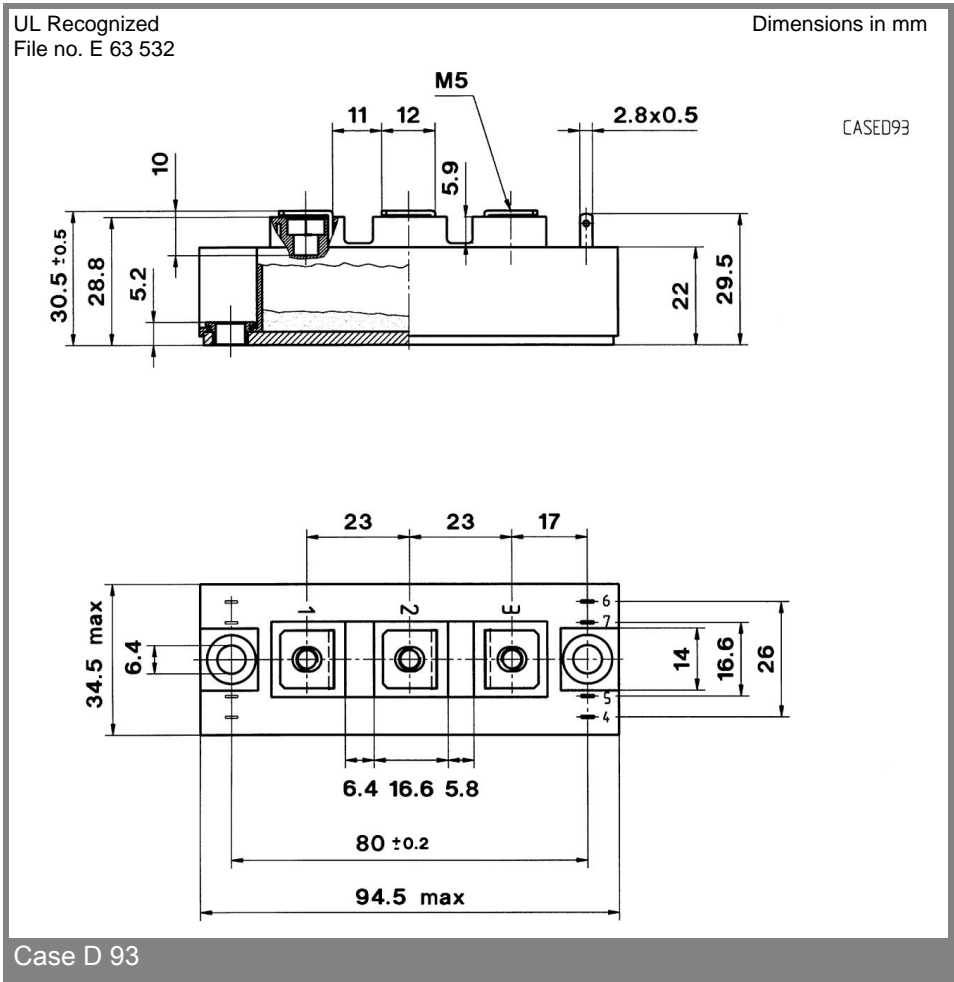
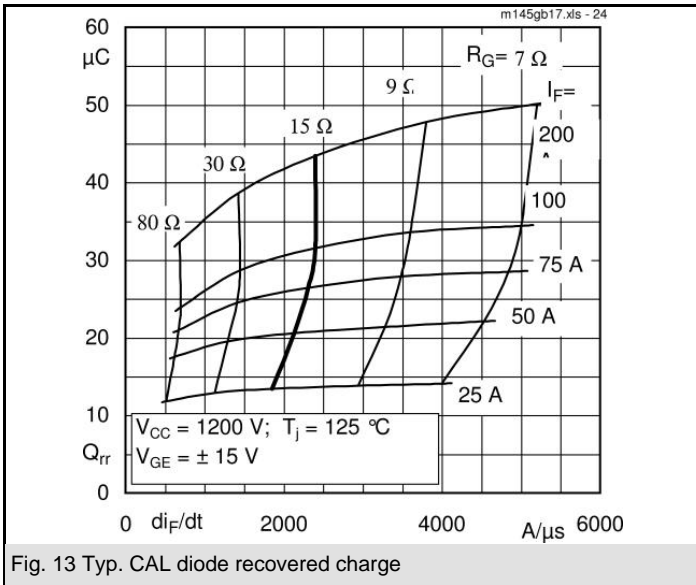

This is an electrostatic discharge sensitive device (ESDS), international standard IEC 60747-1, Chapter IX.

This technical information specifies semiconductor devices but promises no characteristics. No warranty or guarantee expressed or implied is made regarding delivery, performance or suitability.