

SEMITOP[®] 2

IGBT Module

SK8GD126

Preliminary Data

Features

- Fast TRENCH IGBTs
- Soft freewheeling diodes in CAL High Density technology
- Compact design
- One screw mounting
- Heat transfer and isolation through direct copper bonded aluminium oxide ceramic (DCB)

Typical Applications

- Switching (not for linear use)
- Inverter
- Switched mode power supplies
- UPS

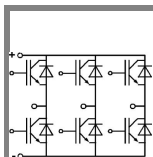

GD

Absolute Maximum Ratings		$T_s = 25\text{ °C}$, unless otherwise specified	
Symbol	Conditions	Values	Units
IGBT			
V_{CES}	$T_j = 25\text{ °C}$	1200	V
I_C	$T_j = 150\text{ °C}$	$T_s = 25\text{ °C}$	15 A
		$T_s = 80\text{ °C}$	10 A
I_{CRM}	$I_{CRM} = 2 \times I_{Cnom}$	16	A
V_{GES}		± 20	V
t_{psc}	$V_{CC} = 600\text{ V}; V_{GE} \leq 20\text{ V}; T_j = 125\text{ °C}$ $V_{CES} < 1200\text{ V}$	10	μs
Inverse Diode			
I_F	$T_j = 150\text{ °C}$	$T_s = 25\text{ °C}$	13 A
		$T_s = 80\text{ °C}$	9 A
I_{FRM}	$I_{FRM} = 2 \times I_{Fnom}$		A
I_{FSM}	$t_p = 10\text{ ms}; \text{half sine wave } T_j = 150\text{ °C}$	55	A
Module			
$I_{t(RMS)}$			A
T_{vj}		-40 ... +150	$^{\circ}\text{C}$
T_{stg}		-40 ... +125	$^{\circ}\text{C}$
V_{isol}	AC, 1 min.	2500	V

Characteristics		$T_s = 25\text{ °C}$, unless otherwise specified			
Symbol	Conditions	min.	typ.	max.	Units
IGBT					
$V_{GE(th)}$	$V_{GE} = V_{CE}, I_C = 0,3\text{ mA}$	5	5,8	6,5	V
I_{CES}	$V_{GE} = 1200\text{ V}, V_{CE} = V_{CES}$	$T_j = 25\text{ °C}$		0,05	mA
		$T_j = 125\text{ °C}$			mA
I_{GES}	$V_{CE} = 0\text{ V}, V_{GE} = 20\text{ V}$	$T_j = 25\text{ °C}$		120	nA
		$T_j = 125\text{ °C}$			nA
V_{CE0}		$T_j = 25\text{ °C}$	1	1,2	V
		$T_j = 125\text{ °C}$	0,9		V
r_{CE}	$V_{GE} = 15\text{ V}$	$T_j = 25\text{ °C}$	87,5		$\text{m}\Omega$
		$T_j = 125\text{ °C}$	137		$\text{m}\Omega$
$V_{CE(sat)}$	$I_{Cnom} = 8\text{ A}, V_{GE} = 15\text{ V}$	$T_j = 25\text{ °C}_{chiplev.}$	1,7	2,2	V
		$T_j = 125\text{ °C}_{chiplev.}$	2		V
C_{ies}	$V_{CE} = 25, V_{GE} = 0\text{ V}$	$f = 1\text{ MHz}$	0,605		nF
C_{oes}			0,037		nF
C_{res}			0,029		nF
$t_{d(on)}$	$R_{Gon} = 50\ \Omega$	$V_{CC} = 600\text{ V}$ $I_{Cnom} = 8\text{ A}$	85		ns
t_r			30		ns
E_{on}	$R_{Goff} = 50\ \Omega$	$T_j = 125\text{ °C}$ $V_{GE} = \pm 15\text{ V}$	0,78		mJ
$t_{d(off)}$			430		ns
t_f			90		ns
E_{off}			0,96		mJ
$R_{th(j-s)}$	per IGBT			2	K/W



SEMITOP[®] 2

IGBT Module

SK8GD126

Preliminary Data

Features

- Fast TRENCH IGBTs
- Soft freewheeling diodes in CAL High Density technology
- Compact design
- One screw mounting
- Heat transfer and isolation through direct copper bonded aluminium oxide ceramic (DCB)

Typical Applications

- Switching (not for linear use)
- Inverter
- Switched mode power supplies
- UPS

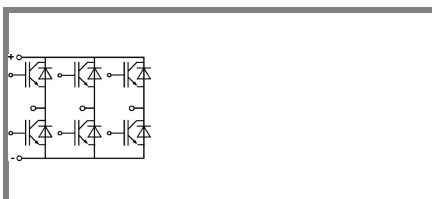

GD

Characteristics

Symbol	Conditions	min.	typ.	max.	Units
Inverse Diode					
$V_F = V_{EC}$	$I_{Fnom} = 8 \text{ A}; V_{GE} = 0 \text{ V}$	$T_j = 25 \text{ }^\circ\text{C}_{\text{chiplev.}}$	1,9	22	V
		$T_j = 125 \text{ }^\circ\text{C}_{\text{chiplev.}}$	2	2,4	V
V_{F0}		$T_j = 25 \text{ }^\circ\text{C}$	1	1,1	V
		$T_j = 125 \text{ }^\circ\text{C}$	0,8		V
r_F		$T_j = 25 \text{ }^\circ\text{C}$	112	138	mΩ
		$T_j = 125 \text{ }^\circ\text{C}$	150		mΩ
I_{RRM}	$I_{Fnom} = 8 \text{ A}$	$T_j = 125 \text{ }^\circ\text{C}$	9,4		A
Q_{rr}	$di/dt = -300 \text{ A}/\mu\text{s}$		1,5		μC
E_{rr}	$V_{CC} = 600\text{V}$		20,6		mJ
$R_{th(j-s)D}$	per diode			2,8	K/W
M_s	to heat sink			2	Nm
w			21		g

This is an electrostatic discharge sensitive device (ESDS), international standard IEC 60747-1, Chapter IX.

This technical information specifies semiconductor devices but promises no characteristics. No warranty or guarantee expressed or implied is made regarding delivery, performance or suitability.

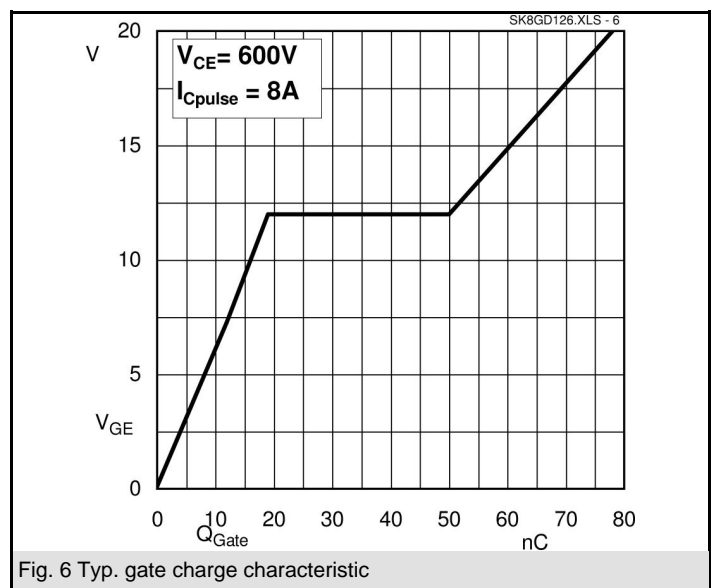
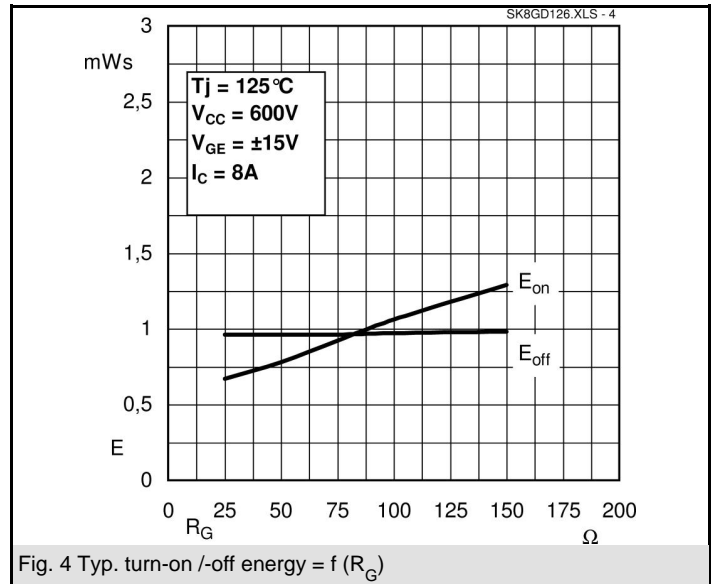
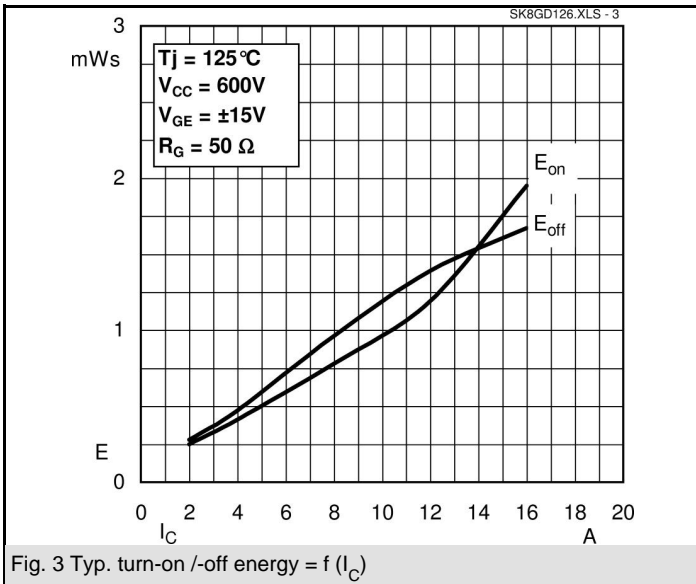
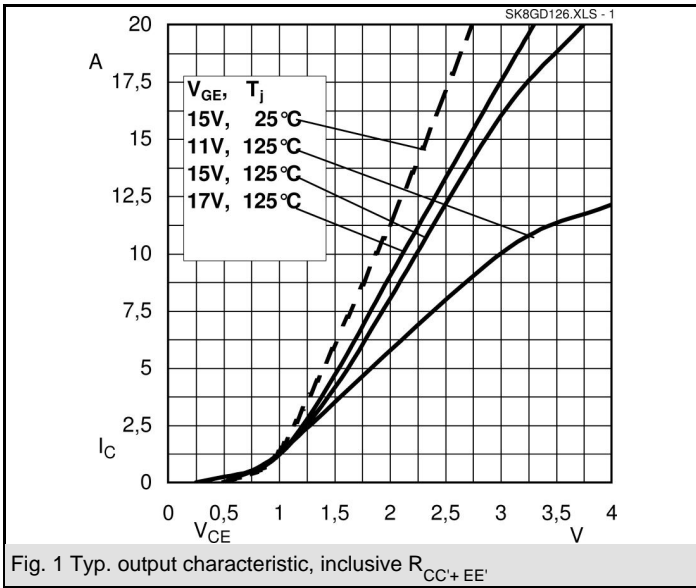

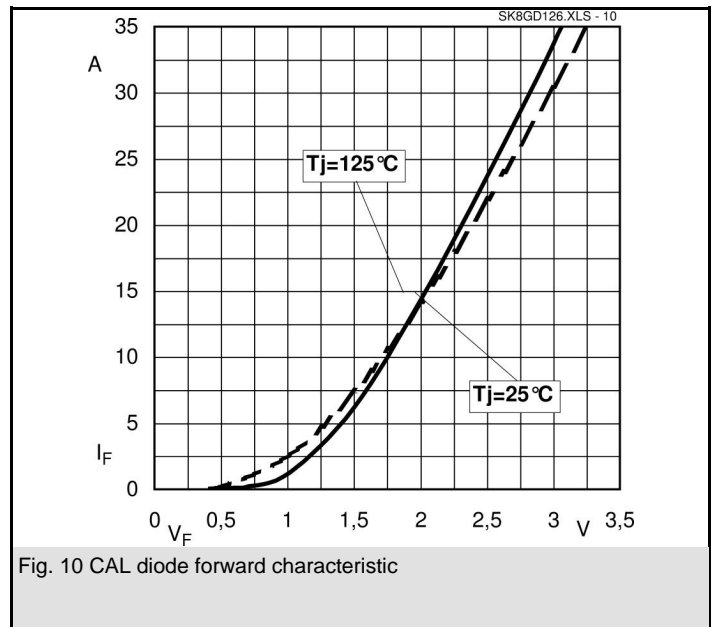
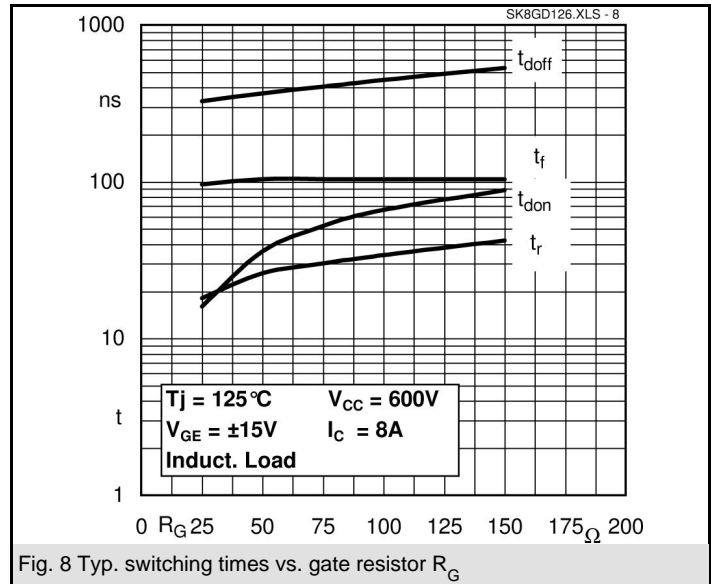
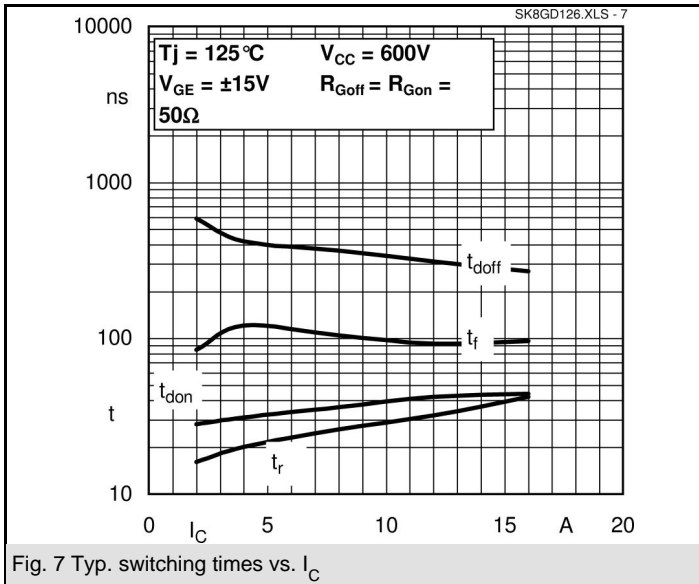

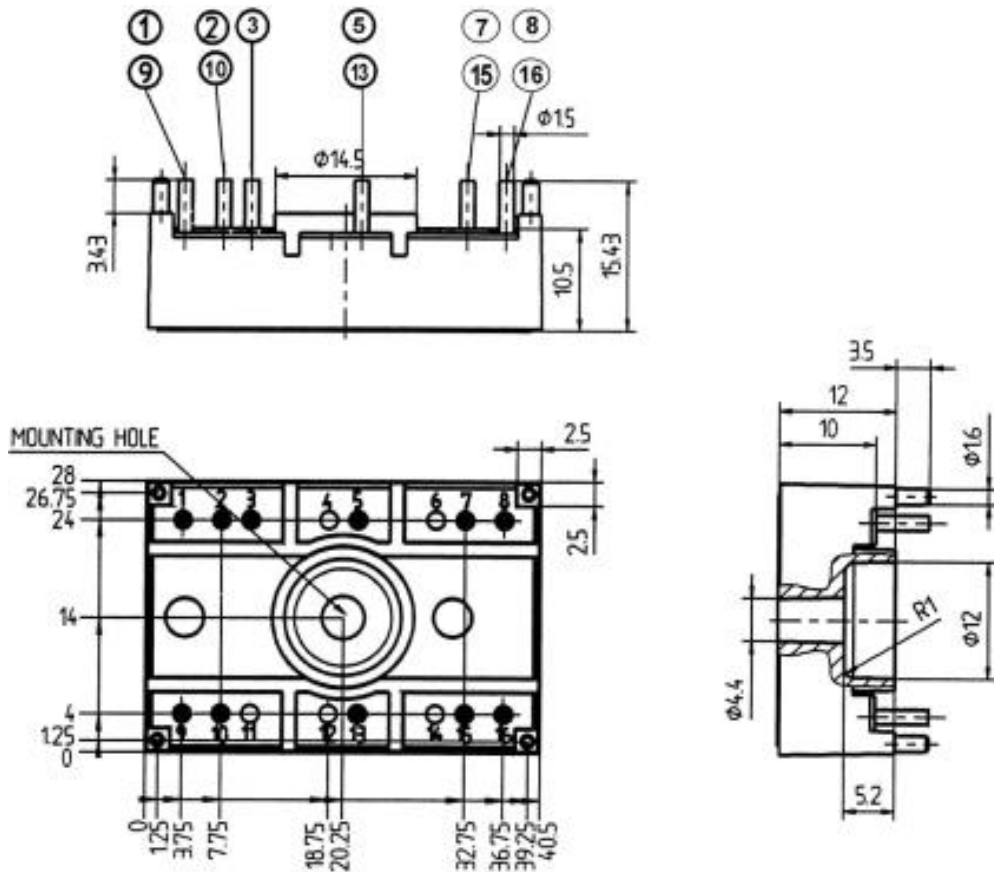

Case T47 (Suggested hole diameter, in the PCB, for solder pins and plastic mounting pins: 2mm)

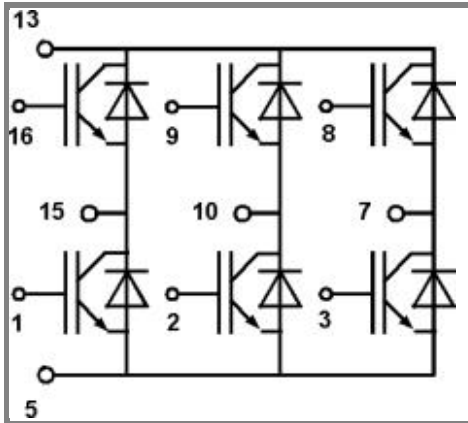

Case T47

GD