

SK 20 GD 065 ET

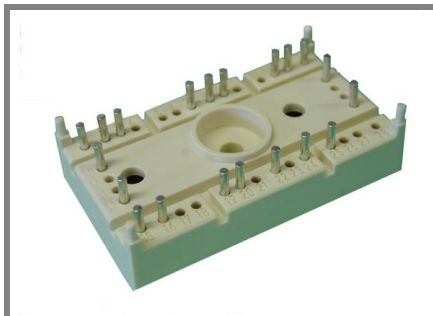

SEMITOP[®] 3

3-phase bridge inverter

SK 20 GD 065 ET

Preliminary Data

Features

- Compact design
- One screw mounting
- Heat transfer and isolation through direct copper bonded aluminum oxide ceramic (DCB)
- Ultrafast NPT technology IGBT
- CAL Technology FWD
- Integrated NTC temperature sensor

Typical Applications

- Inverter

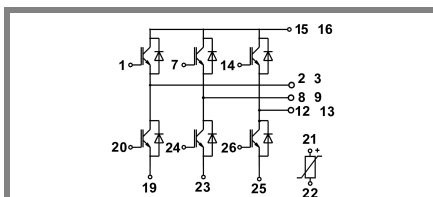

GD - ET

Absolute Maximum Ratings		T _s = 25°C, unless otherwise specified	
Symbol	Conditions	Values	Units
IGBT - Inverter, Chopper			
V _{CES}		600	V
I _C	T _s = 25 (80) °C	26 (18)	A
I _{CM}	T _s = 25 (80) °C, tp ≤ 1 ms	52 (36)	A
V _{GES}		±20	V
T _j		-40 ... +150	°C
Diode - Inverter, Chopper			
I _F	T _s = 25 (80) °C	27 (19)	A
I _{FM} = -I _{CM}	T _s = 25 (80) °C, tp ≤ 1 ms	54 (38)	A
T _j		-40 ... +150	°C
Rectifier			
V _{RRM}			V
I _{FAV} / I _{TAV}	T _s = °C		A
I _{FSM} / I _{TSM}	t _p = ms, sin°, T _j = °C		A
I _t ²	t _p = ms, sin°, T _j = °C		A ² s
T _j			°C
T _{sol}	Terminals, 10s	260	°C
T _{stg}		-40, ... +125	°C
V _{isol}	AC, 1 min. / 1s	2500 / 3000	V

Characteristics		T _s = 25°C, unless otherwise specified			
Symbol	Conditions	min.	typ.	max.	Units
IGBT - Inverter, Chopper					
V _{CEsat}	I _C = 20 A, T _j = 25 (125) °C		2,1 (2,2)	2,5	V
V _{GE(th)}	V _{GE} = V _{CE} , I _C = 0,5 mA	3	4	5	V
V _{CE(TO)}	T _j = °C () °C		1,2 (1,1)	1,3	V
r _T	T _j = °C () °C		40 (55)	60	mΩ
C _{ies}	V _{CE} = V _{GE} = 0 V, f = 1 MHz		1,2		nF
C _{oes}	V _{CE} = V _{GE} = 0 V, f = 1 MHz		-		nF
C _{res}	V _{CE} = V _{GE} = 0 V, f = 1 MHz		-		nF
R _{th(j-s)}	per IGBT			1,7	K/W
t _{d(on)}	under following conditions		-		ns
t _r	V _{CC} = 300 V, V _{GE} = ± 15 V		-		ns
t _{d(off)}	I _C = 20 A, T _j = 125 °C		-		ns
t _f	R _{Gon} = R _{Goff} = - Ω		-		ns
E _{on}	inductive load		0,6		mJ
E _{off}			0,44		mJ
Diode - Inverter, Chopper					
V _F = V _{EC}	I _F = 20 A, T _j = 25 (125) °C		1,6 (1,6)		V
V _(TO)	T _j = 25 °C (125) °C		1 (0,9)		V
r _T	T _j = 25 °C (125) °C		(52)		mΩ
R _{th(j-s)}	per diode			1,9	K/W
I _{RRM}	under following conditions		-		A
Q _{rr}	I _F = A, V _R = V		-		μC
E _{rr}	V _{GE} = 0 V, T _j = 125 °C		-		mJ
	di _F /dt = - A/μs				
Diode rectifier					
V _F	I _F = A, T _j = 25 °C				V
V _(TO)	T _j = °C				V
r _T	T _j = °C				mΩ
R _{th(j-s)}	per diode				K/W
Temperatur sensor					
R _{ts}	5 %, T _r = 25 (100) °C		5000(493)		Ω
Mechanical data					
w			30		g
M _s	Mounting torque			2,5	Nm

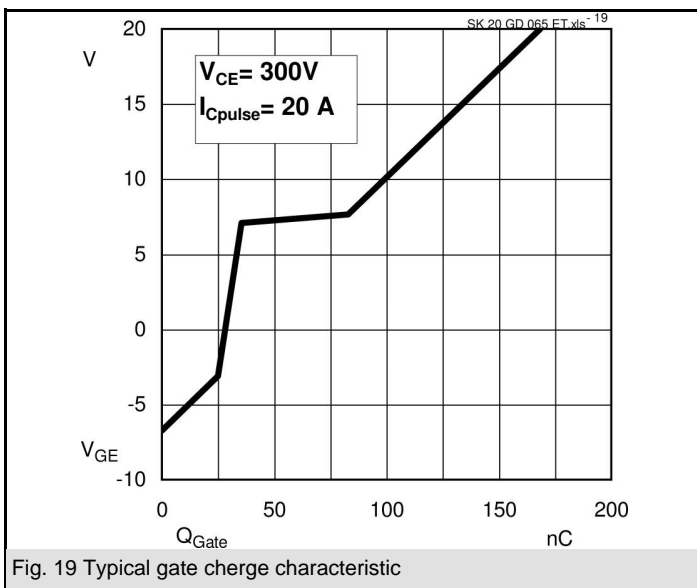
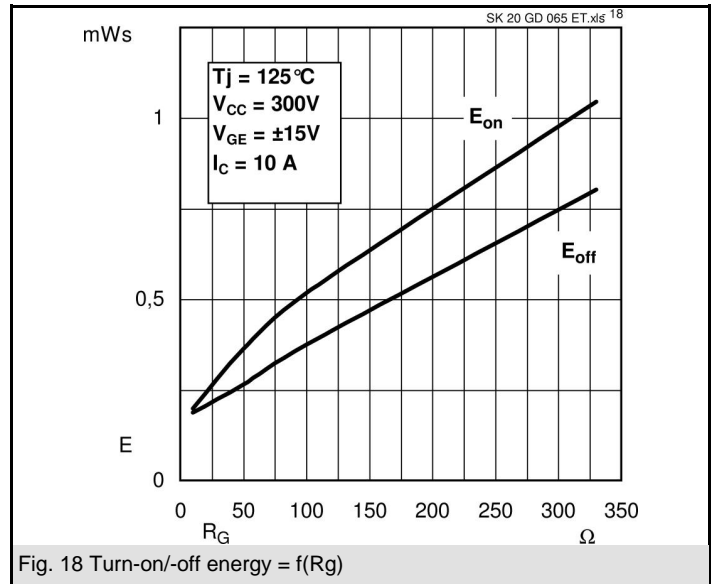
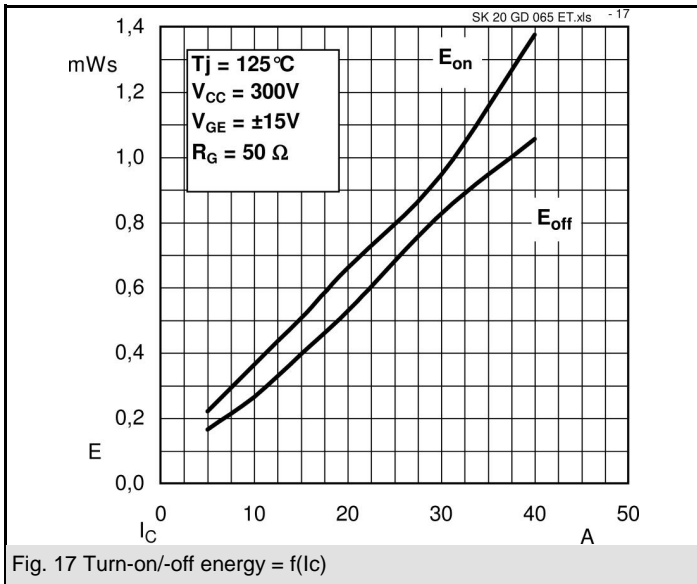
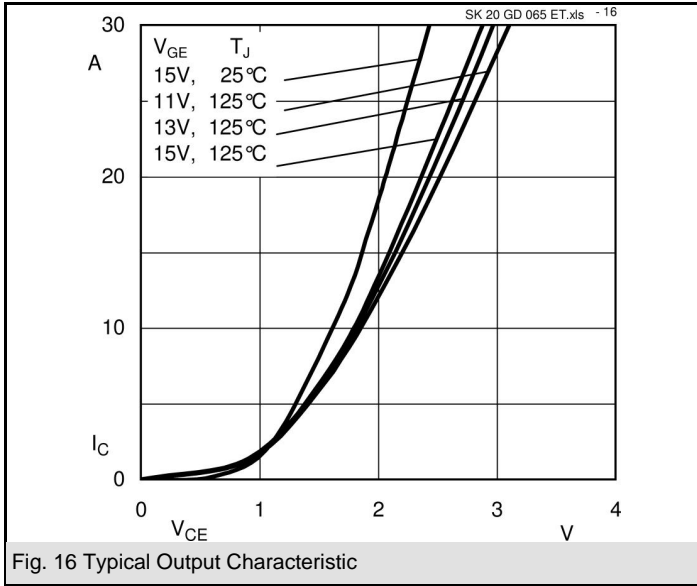

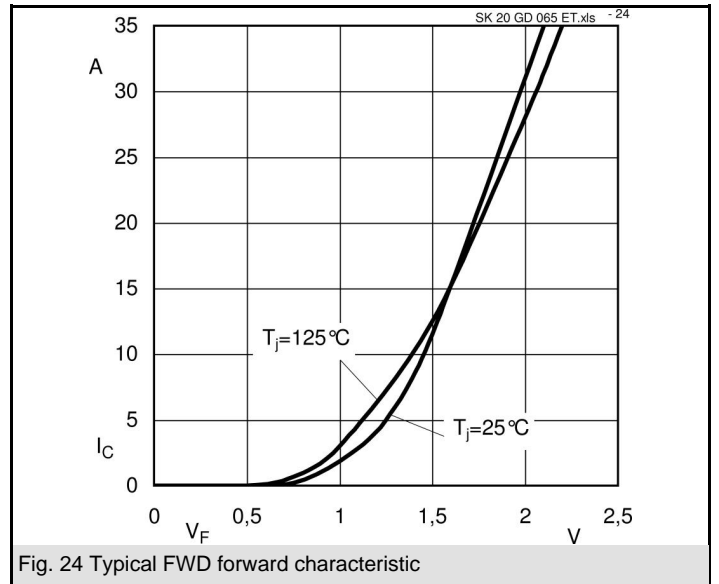
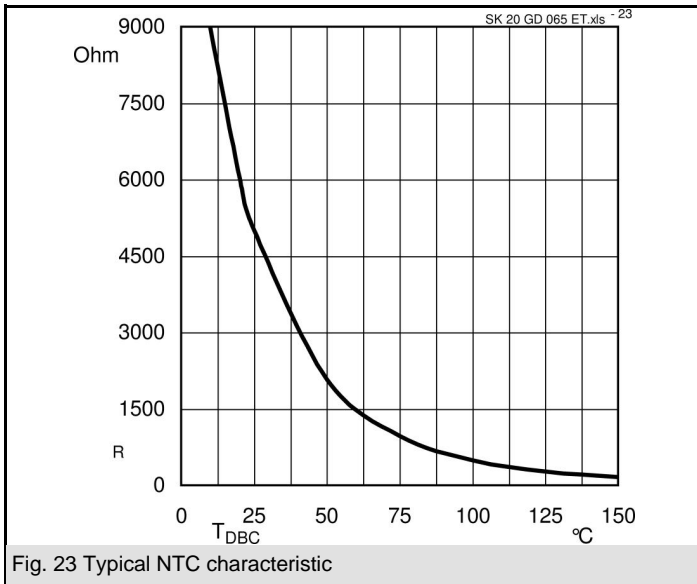
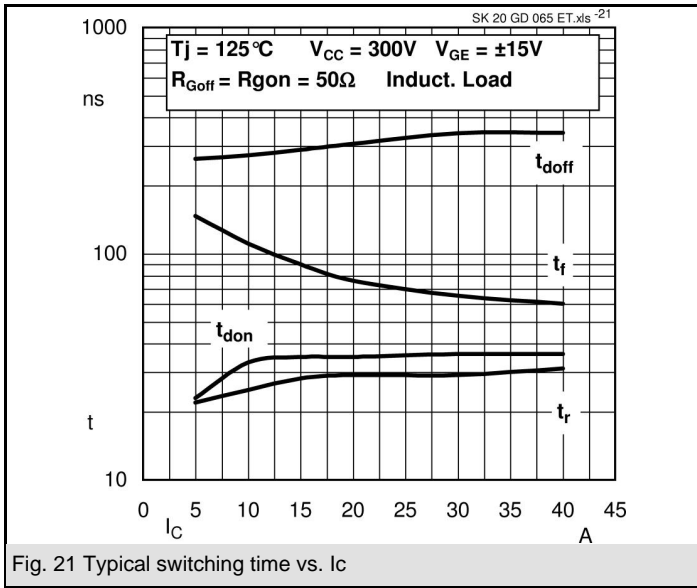

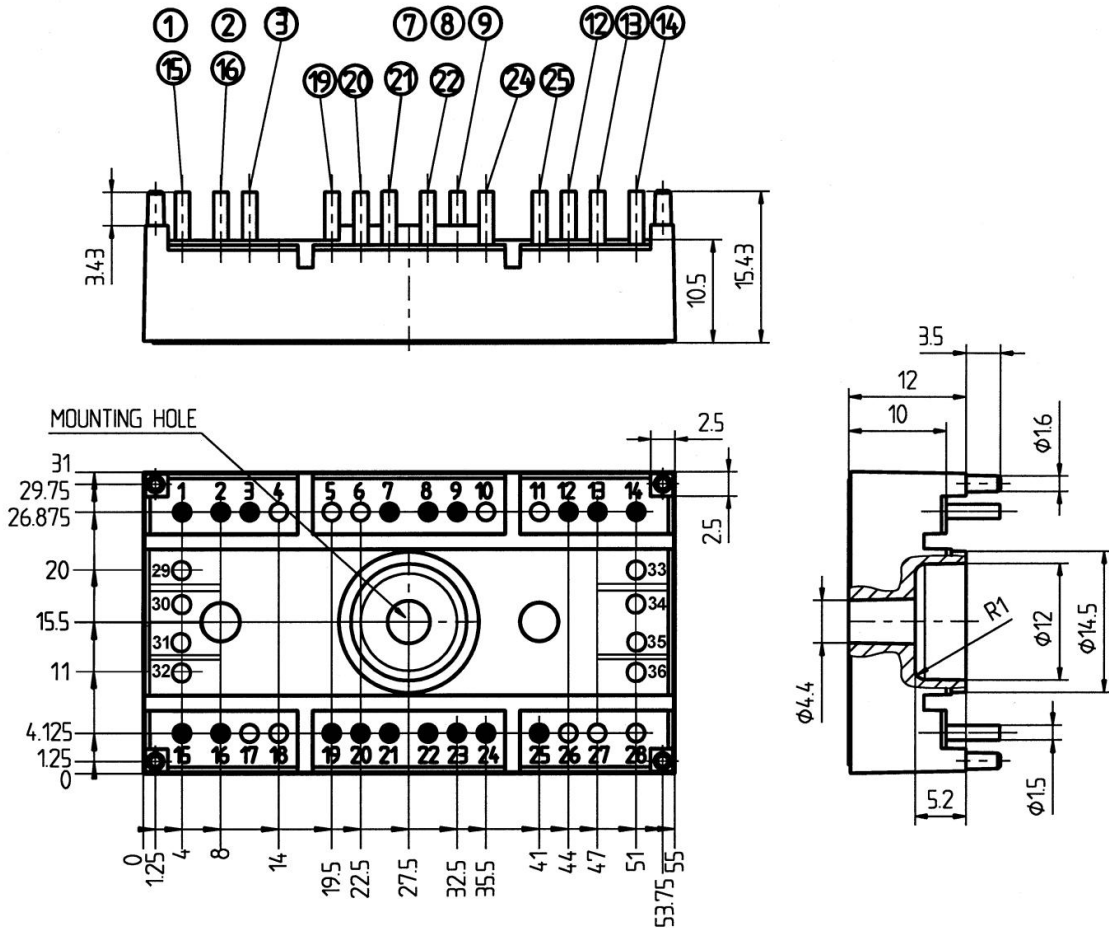

Case T 52 (Suggested hole diameter, in the PCB, for solder pins and plastic mounting pins: 2mm)

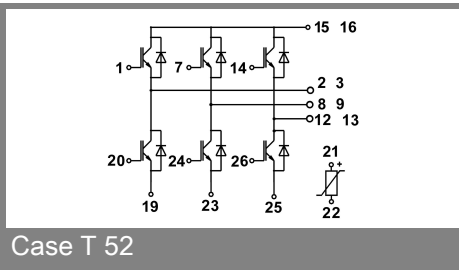

Case T 52

This is an electrostatic discharge sensitive device (ESDS), international standard IEC 60747-1, Chapter IX.

This technical information specifies semiconductor devices but promises no characteristics. No warranty or guarantee expressed or implied is made regarding delivery, performance or suitability.