

SEMiX452GAR126HDs



SEMiX[®]2s

Trench IGBT Modules

SEMiX452GAR126HDs

Preliminary Data

Features

- Homogeneous Si
- Trench = Trenchgate technology
- $V_{CE(sat)}$ with positive temperature coefficient
- High short circuit capability
- UL recognised file no. E63532

Typical Applications

- AC inverter drives
- UPS
- Electronic Welding

Remarks

- Case temperatur limited to $T_C=125^\circ\text{C}$ max.
- Not for new design

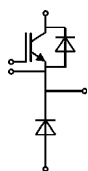

GAR

Absolute Maximum Ratings

Symbol	Conditions	Values	Unit	
IGBT				
V_{CES}		1200	V	
I_C	$T_j = 150^\circ\text{C}$	$T_c = 25^\circ\text{C}$	455	A
		$T_c = 80^\circ\text{C}$	319	A
I_{Cnom}		300	A	
I_{CRM}	$I_{CRM} = 2 \times I_{Cnom}$	600	A	
V_{GES}		-20 ... 20	V	
t_{psc}	$V_{CC} = 600\text{ V}$		10	μs
	$V_{GE} \leq 20\text{ V}$			
	$T_j = 125^\circ\text{C}$			
	$V_{CES} \leq 1200\text{ V}$			
T_j		-40 ... 150	$^\circ\text{C}$	
Inverse diode				
I_F	$T_j = 150^\circ\text{C}$	$T_c = 25^\circ\text{C}$	394	A
		$T_c = 80^\circ\text{C}$	272	A
I_{Fnom}		300	A	
I_{FRM}	$I_{FRM} = 2 \times I_{Fnom}$	600	A	
I_{FSM}	$t_p = 10\text{ ms, sin } 180^\circ, T_j = 25^\circ\text{C}$	1900	A	
T_j		-40 ... 150	$^\circ\text{C}$	
Freewheeling diode				
I_F	$T_j = 150^\circ\text{C}$	$T_c = 25^\circ\text{C}$	394	A
		$T_c = 80^\circ\text{C}$	272	A
I_{Fnom}		300	A	
I_{FRM}	$I_{FRM} = 2 \times I_{Fnom}$	600	A	
I_{FSM}	$t_p = 10\text{ ms, sin } 180^\circ, T_j = 25^\circ\text{C}$	1900	A	
T_j		-40 ... 150	$^\circ\text{C}$	
Module				
$I_{t(RMS)}$		600	A	
T_{stg}		-40 ... 125	$^\circ\text{C}$	
V_{isol}	AC sinus 50Hz, $t = 1\text{ min}$	4000	V	

Characteristics

Symbol	Conditions	min.	typ.	max.	Unit
IGBT					
$V_{CE(sat)}$	$I_C = 300\text{ A}$ $V_{GE} = 15\text{ V}$ chipllevel	$T_j = 25^\circ\text{C}$	1.7	2.1	V
		$T_j = 125^\circ\text{C}$	2.00	2.45	V
V_{CE0}		$T_j = 25^\circ\text{C}$	1	1.2	V
		$T_j = 125^\circ\text{C}$	0.9	1.1	V
r_{CE}	$V_{GE} = 15\text{ V}$	$T_j = 25^\circ\text{C}$	2.3	3.0	$\text{m}\Omega$
		$T_j = 125^\circ\text{C}$	3.7	4.5	$\text{m}\Omega$
$V_{GE(th)}$	$V_{GE} = V_{CE}, I_C = 12\text{ mA}$	5	5.8	6.5	V
I_{CES}	$V_{GE} = 0\text{ V}$ $V_{CE} = 1200\text{ V}$	$T_j = 25^\circ\text{C}$	0.1	0.3	mA
		$T_j = 125^\circ\text{C}$			mA
C_{ies}	$V_{CE} = 25\text{ V}$		21.5		nF
C_{oes}	$V_{GE} = 0\text{ V}$		1.13		nF
C_{res}			0.98		nF
Q_G	$V_{GE} = -8\text{ V...} + 15\text{ V}$		2400		nC
R_{Gint}	$T_j = 25^\circ\text{C}$		2.50		Ω

SEMiX452GAR126HDs



SEMiX[®]2s

Trench IGBT Modules

SEMiX452GAR126HDs

Preliminary Data

Features

- Homogeneous Si
- Trench = Trenchgate technology
- $V_{CE(sat)}$ with positive temperature coefficient
- High short circuit capability
- UL recognised file no. E63532

Typical Applications

- AC inverter drives
- UPS
- Electronic Welding

Remarks

- Case temperature limited to $T_C=125^\circ\text{C}$ max.
- Not for new design

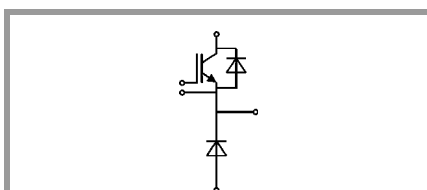

GAR

Characteristics						
Symbol	Conditions		min.	typ.	max.	Unit
$t_{d(on)}$	$V_{CC} = 600\text{ V}$			280		ns
t_r	$I_C = 300\text{ A}$			65		ns
E_{on}	$T_j = 125^\circ\text{C}$			35		mJ
$t_{d(off)}$	$R_{G\ on} = 2\ \Omega$			630		ns
t_f	$R_{G\ off} = 2\ \Omega$			130		ns
E_{off}				45		mJ
$R_{th(j-c)}$	per IGBT				0.083	K/W
$R_{th(j-s)}$	per IGBT					K/W
Inverse diode						
$V_F = V_{EC}$	$I_F = 300\text{ A}$	$T_j = 25^\circ\text{C}$		1.6	1.8	V
	$V_{GE} = 0\text{ V}$	$T_j = 125^\circ\text{C}$		1.6	1.8	V
	chipllevel					
V_{F0}		$T_j = 25^\circ\text{C}$	0.9	1	1.1	V
		$T_j = 125^\circ\text{C}$	0.7	0.8	0.9	V
r_F		$T_j = 25^\circ\text{C}$	1.7	2.0	2.3	m Ω
		$T_j = 125^\circ\text{C}$	2.3	2.7	3.0	m Ω
I_{RRM}	$I_F = 300\text{ A}$	$T_j = 125^\circ\text{C}$		375		A
Q_{rr}	$di/dt_{off} = 6200\text{ A}/\mu\text{s}$	$T_j = 125^\circ\text{C}$		75		μC
E_{rr}	$V_{GE} = -15\text{ V}$	$T_j = 125^\circ\text{C}$		33		mJ
	$V_{CC} = 600\text{ V}$					
$R_{th(j-c)}$	per diode				0.15	K/W
$R_{th(j-s)}$	per diode					K/W
Freewheeling diode						
$V_F = V_{EC}$	$I_F = 300\text{ A}$	$T_j = 25^\circ\text{C}$		1.6	1.8	V
	$V_{GE} = 0\text{ V}$	$T_j = 125^\circ\text{C}$		1.6	1.8	V
	chipllevel					
V_{F0}		$T_j = 25^\circ\text{C}$	0.9	1	1.1	V
		$T_j = 125^\circ\text{C}$	0.7	0.8	0.9	V
r_F		$T_j = 25^\circ\text{C}$	1.7	2.0	2.3	m Ω
		$T_j = 125^\circ\text{C}$	2.3	2.7	3.0	m Ω
I_{RRM}	$I_F = 300\text{ A}$	$T_j = 125^\circ\text{C}$		375		A
Q_{rr}	$di/dt_{off} = 6200\text{ A}/\mu\text{s}$	$T_j = 125^\circ\text{C}$		75		μC
E_{rr}	$V_{GE} = -15\text{ V}$	$T_j = 125^\circ\text{C}$		33		mJ
	$V_{CC} = 600\text{ V}$					
$R_{th(j-c)}$	per diode				0.15	K/W
$R_{th(j-s)}$	per diode					K/W
Module						
L_{CE}				18		nH
$R_{CC+EE'}$	res., terminal-chip	$T_C = 25^\circ\text{C}$		0.7		m Ω
		$T_C = 125^\circ\text{C}$		1		m Ω
$R_{th(c-s)}$	per module			0.045		K/W
M_s	to heat sink (M5)		3		5	Nm
M_t		to terminals (M6)	2.5		5	Nm
						Nm
w					250	g
Temperature sensor						
R_{100}	$T_C=100^\circ\text{C}$ ($R_{25}=5\text{ k}\Omega$)			0,493	$\pm 5\%$	k Ω
$B_{100/125}$	$R_{(T)}=R_{100}\exp[B_{100/125}(1/T-1/T_{100})]$; $T[\text{K}]$;			3550	$\pm 2\%$	K

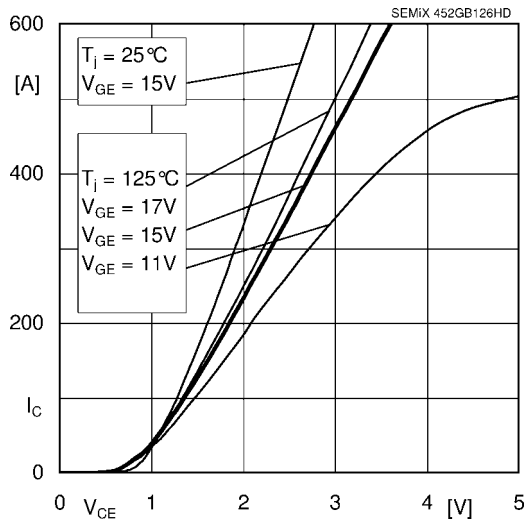

Fig. 1 Typ. output characteristic, inclusive $R_{CC'+EE'}$

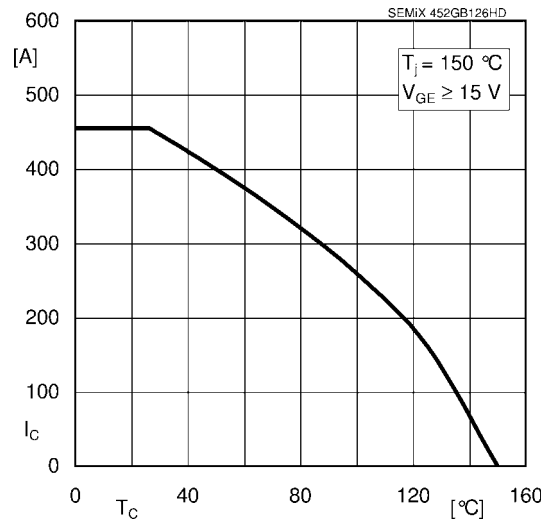

Fig. 2 Rated current vs. temperature $I_C = f(T_C)$

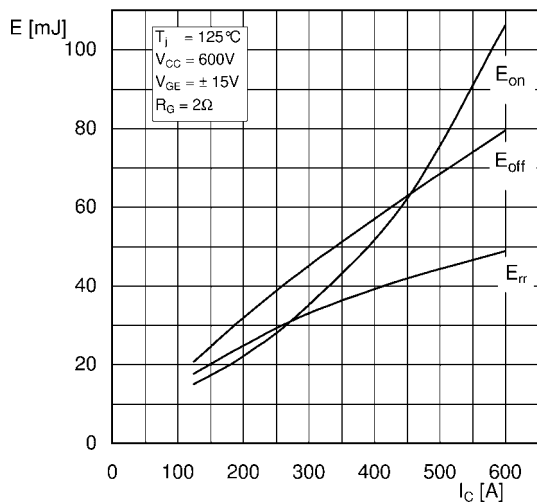

Fig. 3 Typ. turn-on /-off energy = $f(I_C)$

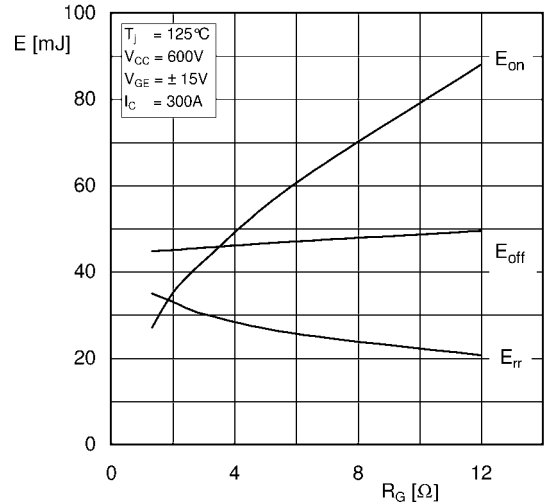

Fig. 4 Typ. turn-on /-off energy = $f(R_G)$

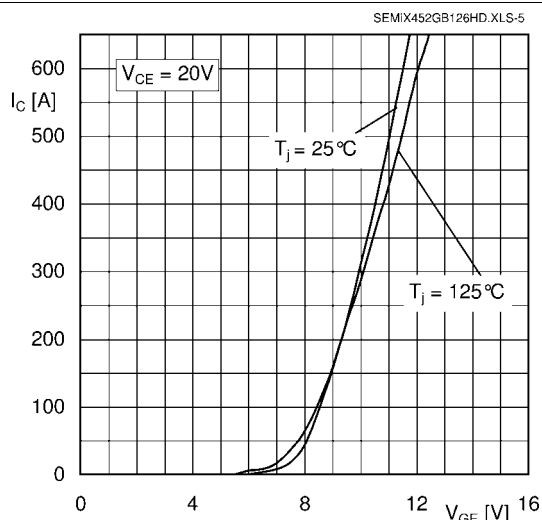

Fig. 5 Typ. transfer characteristic

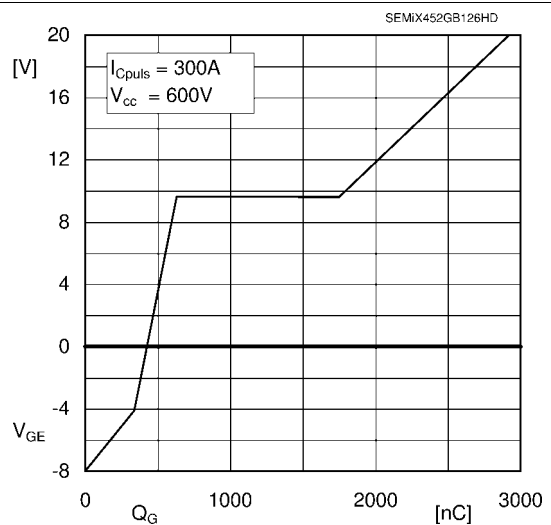

Fig. 6 Typ. gate charge characteristic

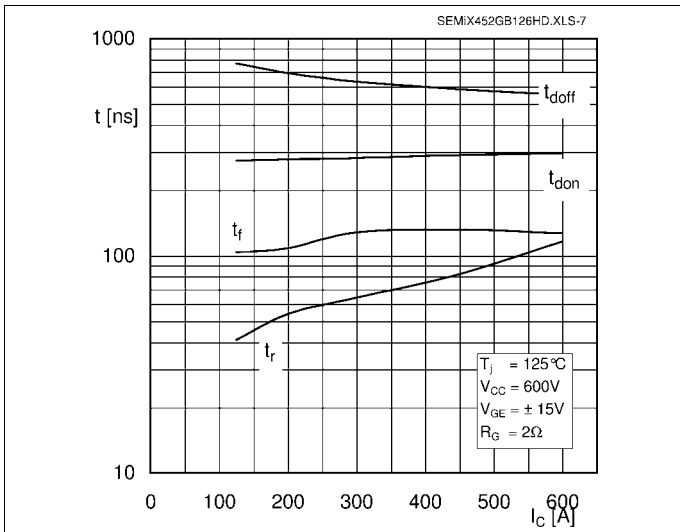

Fig. 7 Typ. switching times vs. I_C

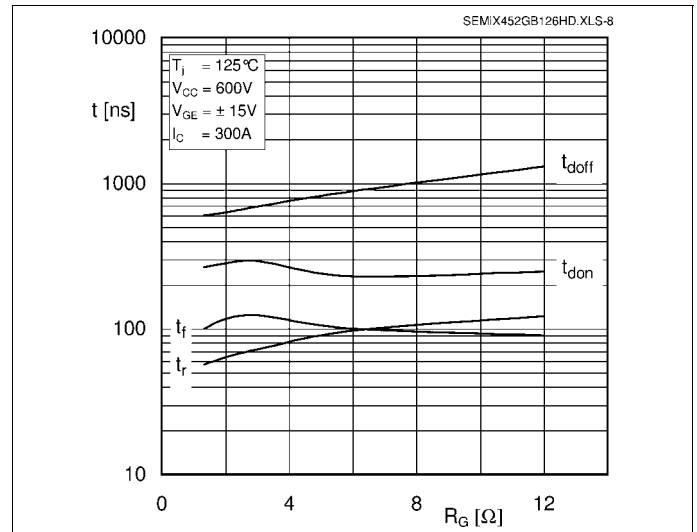

Fig. 8 Typ. switching times vs. gate resistor R_G

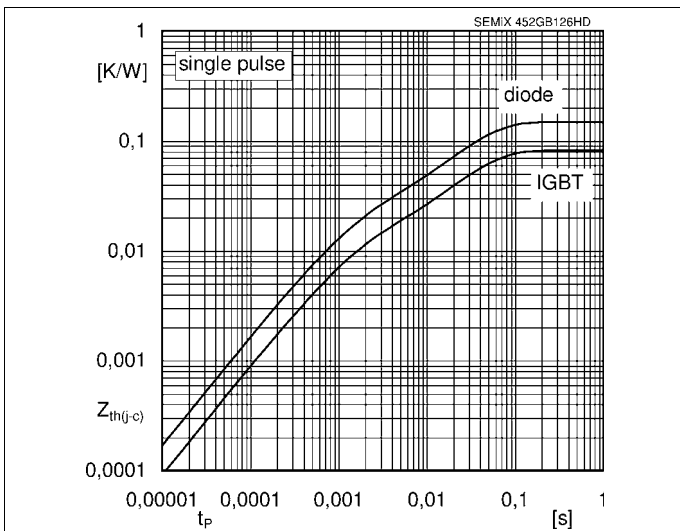

Fig. 9 Typ. transient thermal impedance

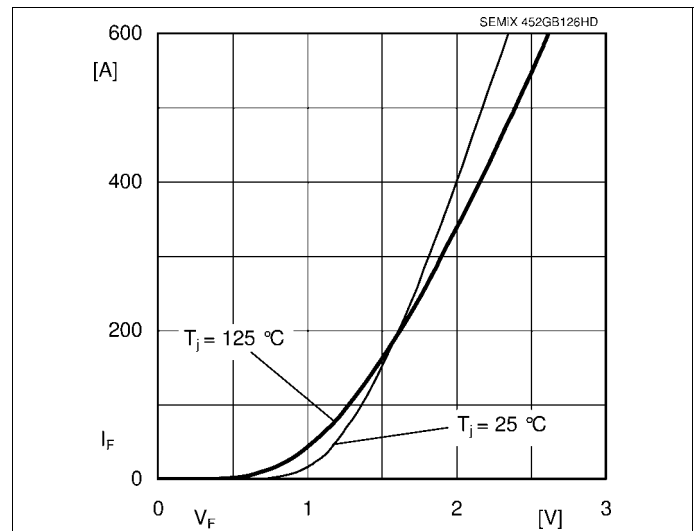

Fig. 10 Typ. CAL diode forward charact., incl. R_{CC+EE}

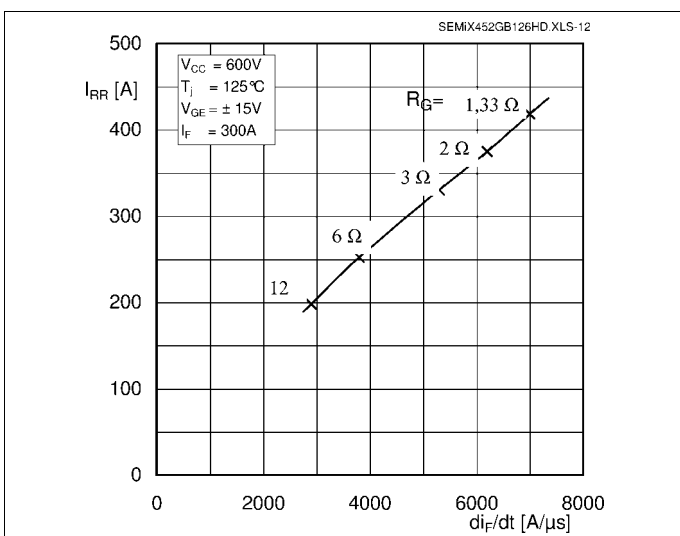

Fig. 11 Typ. CAL diode peak reverse recovery current

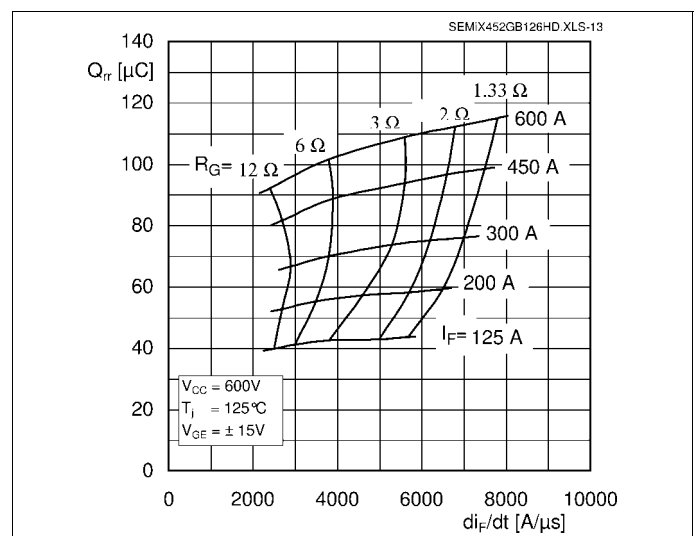
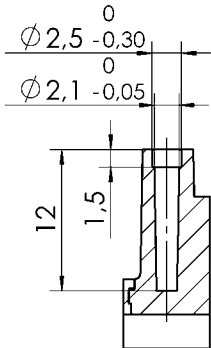

Fig. 12 Typ. CAL diode recovery charge

SEMiX452GAR126HDs

case: SEMiX 2s

screw duct (4x):
A-A (2 : 1)



\square	0,3	main terminal +, - / ~, ~
\parallel	0,2	A

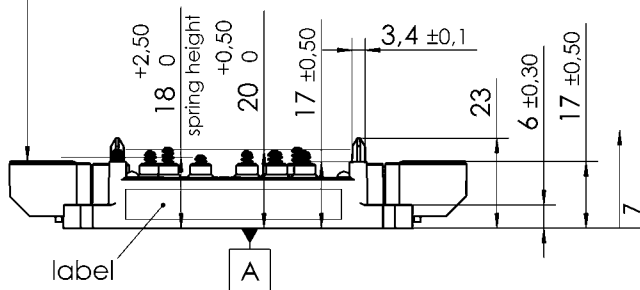

All measures in Z-direction
valid as mounted to heat sink

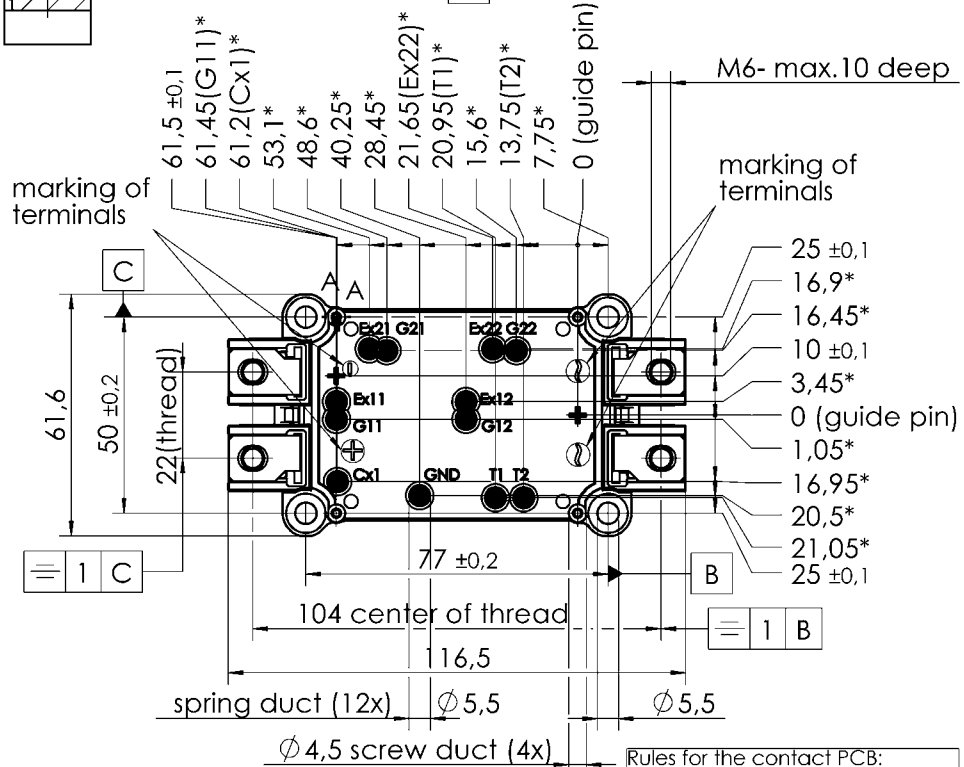

* all measures with \oplus 0,2 B C

Rules for the contact PCB:
- holes guidepins = $\varnothing 4 \pm 0,1$
- spring landing pad = $\varnothing 3,5 \pm 0,2$

SEMiX 2s

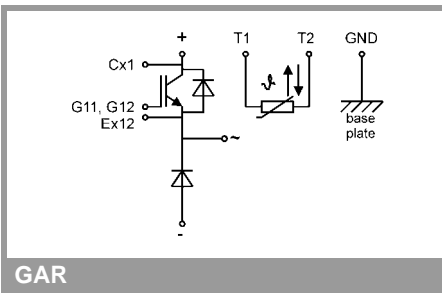

GAR

This is an electrostatic discharge sensitive device (ESDS), international standard IEC 60747-1, Chapter IX

This technical information specifies semiconductor devices but promises no characteristics. No warranty or guarantee expressed or implied is made regarding delivery, performance or suitability.