

# SEMiX151GD12Vs



SEMiX® 13

## SEMiX151GD12Vs

### Features

- Homogeneous Si
- $V_{CE(sat)}$  with positive temperature coefficient
- High short circuit capability
- UL recognised file no. E63532

### Typical Applications\*

- AC inverter drives
- UPS
- Electronic Welding

### Remarks

- Case temperature limited to  $T_C=125^\circ\text{C}$  max.
- Product reliability results are valid for  $T_j=150^\circ\text{C}$

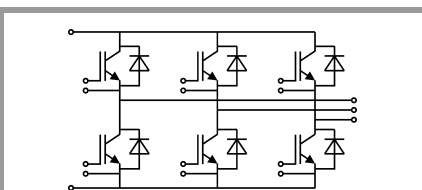

GD

Absolute Maximum Ratings				
Symbol	Conditions	Values	Unit	
<b>IGBT</b>				
$V_{CES}$		1200	V	
$I_C$	$T_j = 175^\circ\text{C}$	$T_c = 25^\circ\text{C}$	231	A
		$T_c = 80^\circ\text{C}$	176	A
$I_{Cnom}$		150	A	
$I_{CRM}$	$I_{CRM} = 3 \times I_{Cnom}$	450	A	
$V_{GES}$		-20 ... 20	V	
$t_{psc}$	$V_{CC} = 600\text{ V}$	$T_j = 125^\circ\text{C}$	10	$\mu\text{s}$
	$V_{GE} \leq 15\text{ V}$			
	$V_{CES} \leq 1200\text{ V}$			
$T_j$		-40 ... 175		$^\circ\text{C}$
<b>Inverse diode</b>				
$I_F$	$T_j = 175^\circ\text{C}$	$T_c = 25^\circ\text{C}$	189	A
		$T_c = 80^\circ\text{C}$	141	A
$I_{Fnom}$		150	A	
$I_{FRM}$	$I_{FRM} = 3 \times I_{Fnom}$	450	A	
$I_{FSM}$	$t_p = 10\text{ ms, sin } 180^\circ, T_j = 25^\circ\text{C}$	900	A	
$T_j$		-40 ... 175		$^\circ\text{C}$
<b>Module</b>				
$I_{t(RMS)}$	$T_{terminal} = 80^\circ\text{C}$	600	A	
$T_{stg}$		-40 ... 125	$^\circ\text{C}$	
$V_{isol}$	AC sinus 50Hz, $t = 1\text{ min}$	4000	V	

Characteristics					
Symbol	Conditions	min.	typ.	max.	Unit
<b>IGBT</b>					
$V_{CE(sat)}$	$I_C = 150\text{ A}$ $V_{GE} = 15\text{ V}$ chipllevel	$T_j = 25^\circ\text{C}$	1.75	2.2	V
		$T_j = 150^\circ\text{C}$	2.2	2.5	V
$V_{CE0}$		$T_j = 25^\circ\text{C}$	0.94	1.04	V
		$T_j = 150^\circ\text{C}$	0.88	0.98	V
$r_{CE}$	$V_{GE} = 15\text{ V}$	$T_j = 25^\circ\text{C}$	5.4	7.7	$\text{m}\Omega$
		$T_j = 150^\circ\text{C}$	8.8	10.1	$\text{m}\Omega$
$V_{GE(th)}$	$V_{GE}=V_{CE}, I_C = 6\text{ mA}$	5.5	6	6.5	V
$I_{CES}$	$V_{GE} = 0\text{ V}$ $V_{CE} = 1200\text{ V}$	$T_j = 25^\circ\text{C}$	0.1	0.3	$\text{mA}$
		$T_j = 150^\circ\text{C}$			$\text{mA}$
$C_{ies}$	$V_{CE} = 25\text{ V}$ $V_{GE} = 0\text{ V}$	$f = 1\text{ MHz}$	9.0		$\text{nF}$
$C_{oes}$		$f = 1\text{ MHz}$	0.89		$\text{nF}$
$C_{res}$		$f = 1\text{ MHz}$	0.88		$\text{nF}$
$Q_G$	$V_{GE} = -8\text{ V...} + 15\text{ V}$		1650		$\text{nC}$
$R_{Gint}$	$T_j = 25^\circ\text{C}$		5.00		$\Omega$
$t_{d(on)}$	$V_{CC} = 600\text{ V}$ $I_C = 150\text{ A}$	$T_j = 150^\circ\text{C}$	319		$\text{ns}$
$t_r$	$V_{GE} = \pm 15\text{ V}$	$T_j = 150^\circ\text{C}$	46		$\text{ns}$
$E_{on}$	$R_{Gon} = 1\ \Omega$	$T_j = 150^\circ\text{C}$	19.4		$\text{mJ}$
$t_{d(off)}$	$R_{Goff} = 1\ \Omega$	$T_j = 150^\circ\text{C}$	482		$\text{ns}$
$t_f$	$di/dt_{on} = 4600\text{ A}/\mu\text{s}$	$T_j = 150^\circ\text{C}$	68		$\text{ns}$
$E_{off}$	$di/dt_{off} = 1700\text{ A}/\mu\text{s}$	$T_j = 150^\circ\text{C}$	17.1		$\text{mJ}$
	$du/dt_{off} = 6700\text{ V}/\mu\text{s}$				
$R_{th(j-c)}$	per IGBT		0.19		$\text{K/W}$

# SEMiX151GD12Vs



SEMiX® 13

## SEMiX151GD12Vs

### Features

- Homogeneous Si
- $V_{CE(sat)}$  with positive temperature coefficient
- High short circuit capability
- UL recognised file no. E63532

### Typical Applications\*

- AC inverter drives
- UPS
- Electronic Welding

### Remarks

- Case temperature limited to  $T_C=125^\circ\text{C}$  max.
- Product reliability results are valid for  $T_j=150^\circ\text{C}$

Characteristics						
Symbol	Conditions		min.	typ.	max.	Unit
<b>Inverse diode</b>						
$V_F = V_{EC}$	$I_F = 150\text{ A}$ $V_{GE} = 0\text{ V}$ chip	$T_j = 25^\circ\text{C}$		2.1	2.46	V
		$T_j = 150^\circ\text{C}$		2.1	2.4	V
$V_{F0}$		$T_j = 25^\circ\text{C}$	1.1	1.3	1.5	V
		$T_j = 150^\circ\text{C}$	0.7	0.9	1.1	V
$r_F$		$T_j = 25^\circ\text{C}$	4.3	5.6	6.4	m $\Omega$
		$T_j = 150^\circ\text{C}$	7.0	7.8	8.5	m $\Omega$
$I_{RRM}$	$I_F = 150\text{ A}$ $di/dt_{off} = 4400\text{ A}/\mu\text{s}$ $V_{GE} = -15\text{ V}$ $V_{CC} = 600\text{ V}$	$T_j = 150^\circ\text{C}$		175		A
$Q_{rr}$		$T_j = 150^\circ\text{C}$		27.5		$\mu\text{C}$
$E_{rr}$		$T_j = 150^\circ\text{C}$			11.5	
$R_{th(j-c)}$	per diode				0.31	K/W
<b>Module</b>						
$L_{CE}$				20		nH
$R_{CC'+EE'}$	res., terminal-chip	$T_C = 25^\circ\text{C}$		0.7		m $\Omega$
		$T_C = 125^\circ\text{C}$		1		m $\Omega$
$R_{th(c-s)}$	per module			0.04		K/W
$M_s$	to heat sink (M5)		3		5	Nm
$M_t$		to terminals (M6)	2.5		5	Nm
						Nm
$w$					350	g
<b>Temperatur Sensor</b>						
$R_{100}$	$T_C=100^\circ\text{C}$ ( $R_{25}=5\text{ k}\Omega$ )			$493 \pm 5\%$		$\Omega$
$B_{100/125}$	$R(T)=R_{100}\exp[B_{100/125}(1/T-1/T_{100})]$ ; $T[\text{K}]$ ;			$3550 \pm 2\%$		K

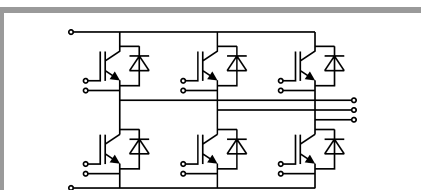

GD

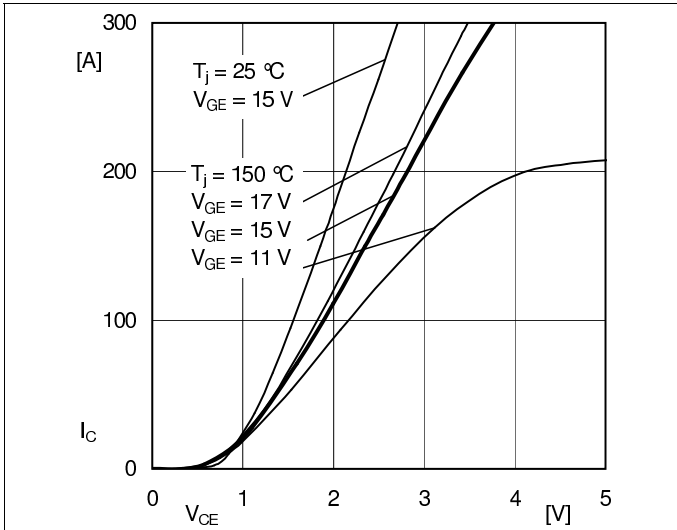

Fig. 1: Typ. output characteristic, inclusive  $R_{CC+EE}$

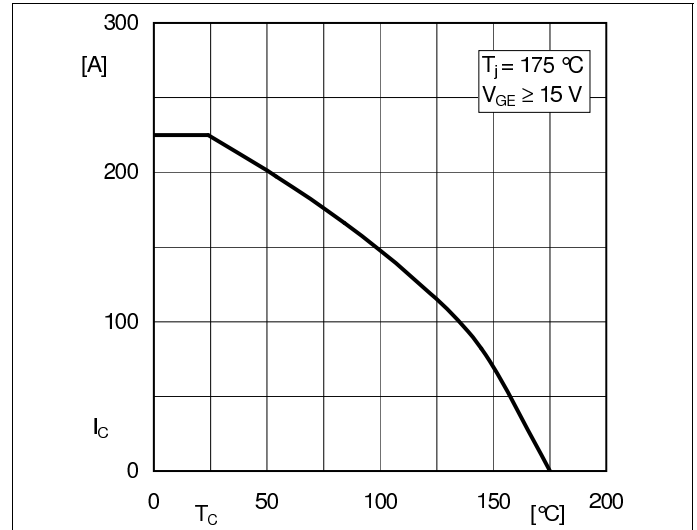

Fig. 2: Rated current vs. temperature  $I_C = f(T_C)$

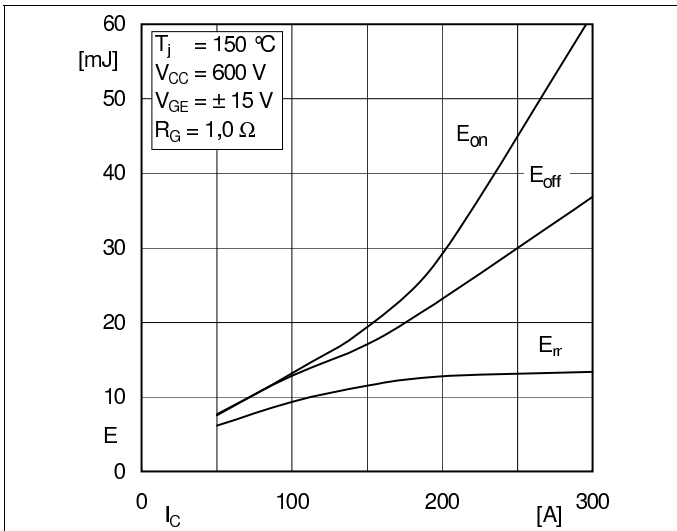

Fig. 3: Typ. turn-on /-off energy =  $f(I_C)$

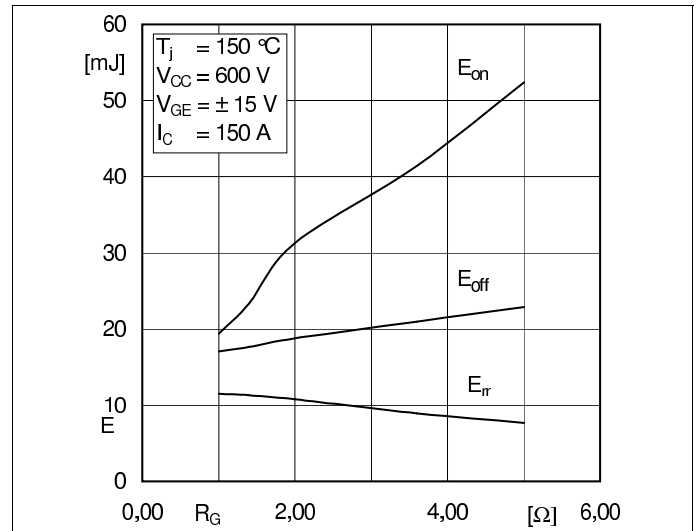

Fig. 4: Typ. turn-on /-off energy =  $f(R_G)$

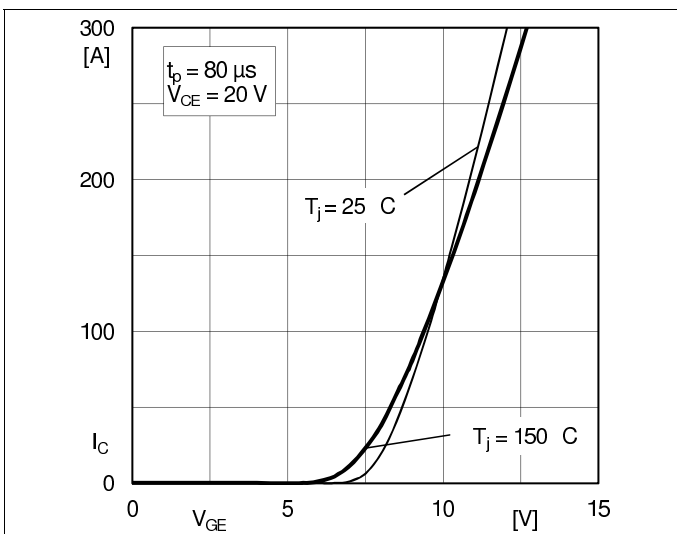

Fig. 5: Typ. transfer characteristic

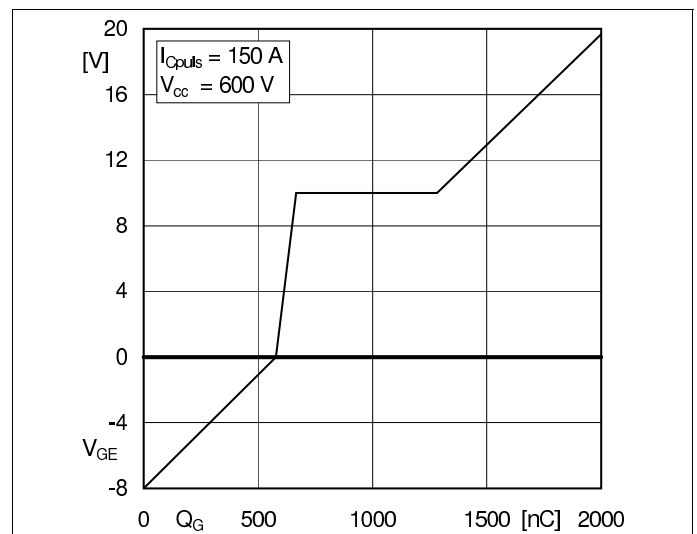

Fig. 6: Typ. gate charge characteristic

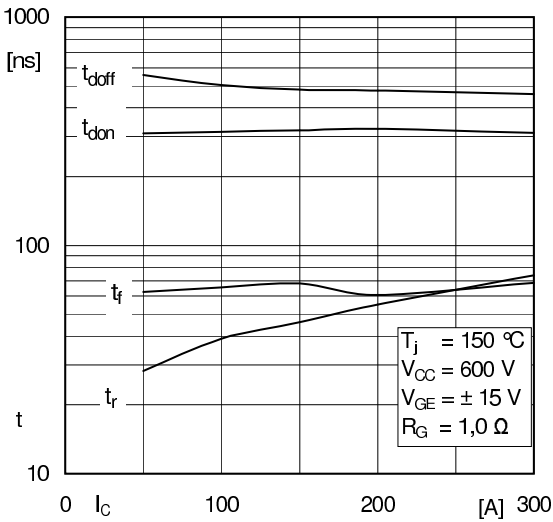

Fig. 7: Typ. switching times vs.  $I_C$

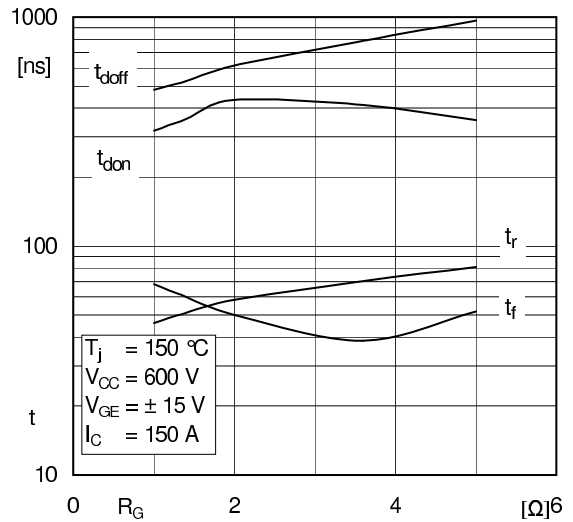

Fig. 8: Typ. switching times vs. gate resistor  $R_G$

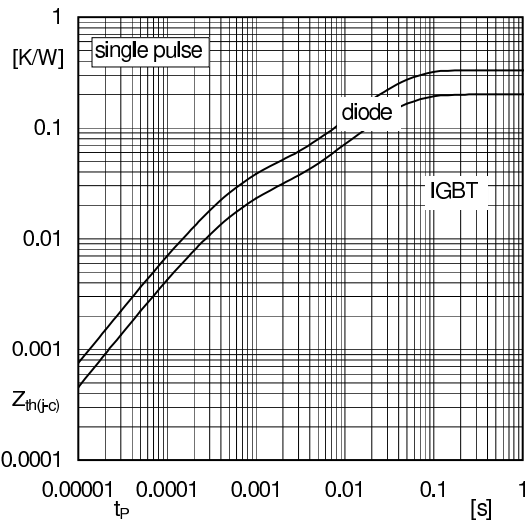

Fig. 9: Typ. transient thermal impedance

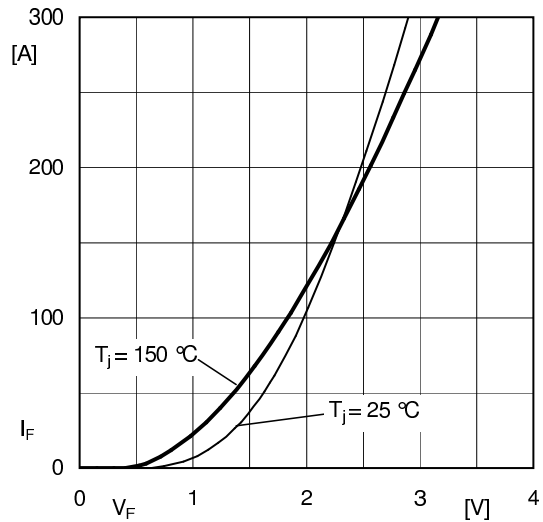

Fig. 10: Typ. CAL diode forward charact., incl.  $R_{CC+EE}$

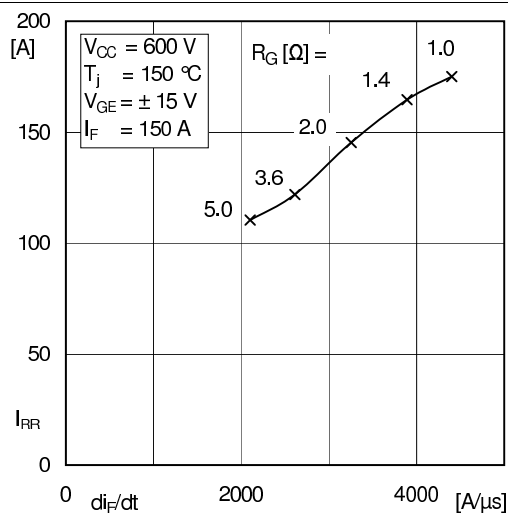

Fig. 11: Typ. CAL diode peak reverse recovery current

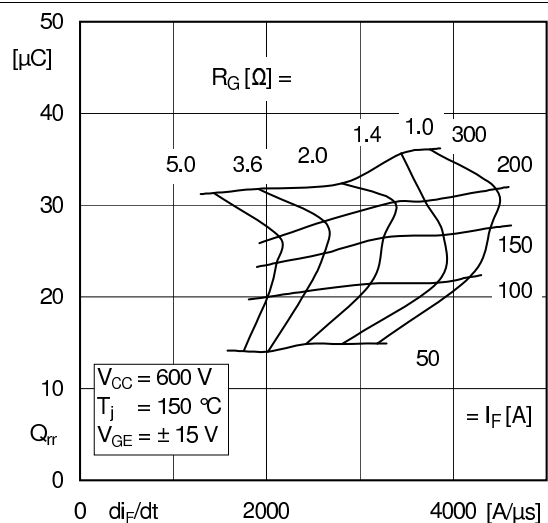
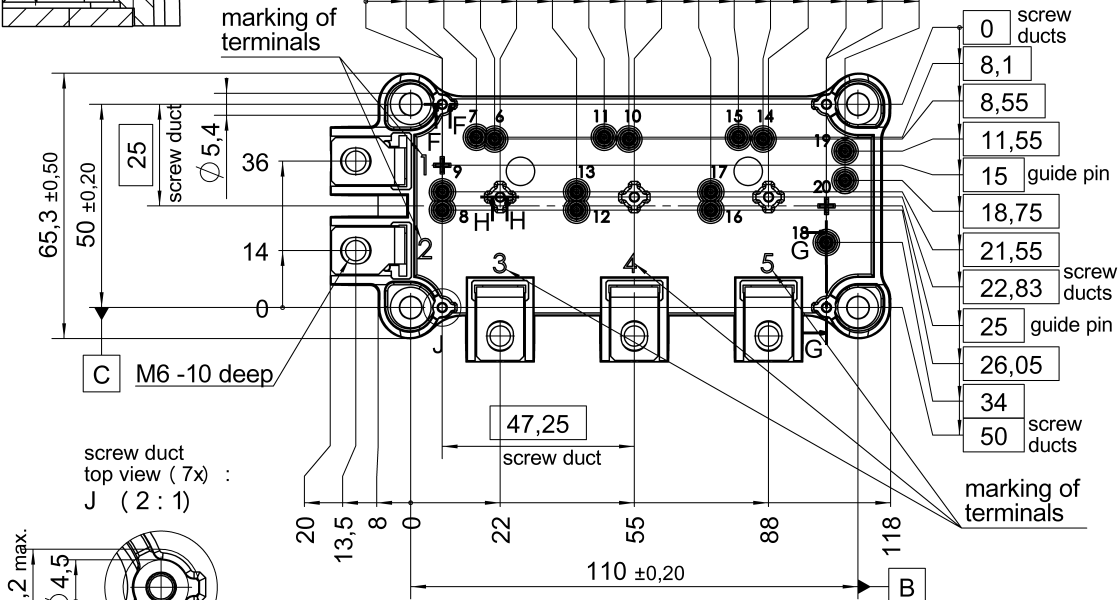
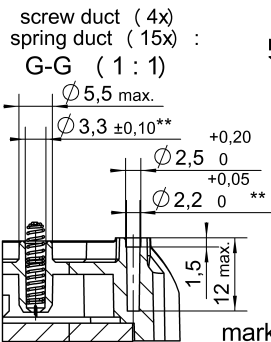
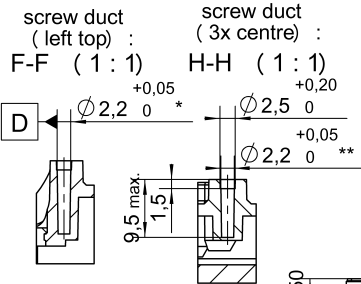

Fig. 12: Typ. CAL diode recovery charge

# SEMiX151GD12Vs

Case: SEMiX 13



$\square$	0,3	connector 1-2 / 3-5
$\parallel$	0,2	each connector A

general tolerance:  
ISO 2768-mK  
ISO 8015

All measures in Z-direction valid when mounted to heat sink

\*screw duct left / top with  $\varnothing 0,2$  A B C

\*\*screw ducts / guide pins / spring ducts with  $\varnothing 0,2$  A D C

Rules for the contact PCB:			
- holes guidepins =	$\varnothing 4 \pm 0,1$	/ position tolerance	$\pm 0,1$
- holes for screws =	$\varnothing 2,9 \pm 0,1$	/ position tolerance	$\pm 0,1$
- spring contact pad =	$\varnothing 3,6 \pm 0,1$	/ position tolerance	$\pm 0,1$

SEMiX 13

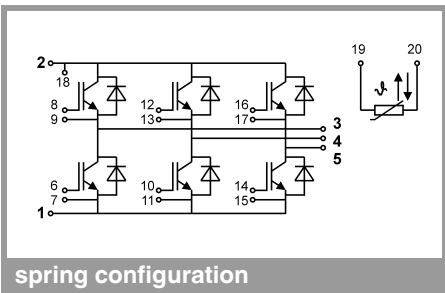

This is an electrostatic discharge sensitive device (ESDS), international standard IEC 60747-1, Chapter IX

\* The specifications of our components may not be considered as an assurance of component characteristics. Components have to be tested for the respective application. Adjustments may be necessary. The use of SEMIKRON products in life support appliances and systems is subject to prior specification and written approval by SEMIKRON. We therefore strongly recommend prior consultation of our staff.