

MITSUBISHI HVIGBT MODULES  
**CM1200HA-50H**

HVIGBT (High Voltage Insulated Gate Bipolar Transistor) Modules

HIGH POWER SWITCHING USE  
 INSULATED TYPE

**CM1200HA-50H**



- IC..... 1200A
- VCES ..... 2500V
- Insulated Type
- 1-element in a pack

**APPLICATION**

Inverters, Converters, DC choppers, Induction heating, DC to DC converters.

**OUTLINE DRAWING & CIRCUIT DIAGRAM**

Dimensions in mm

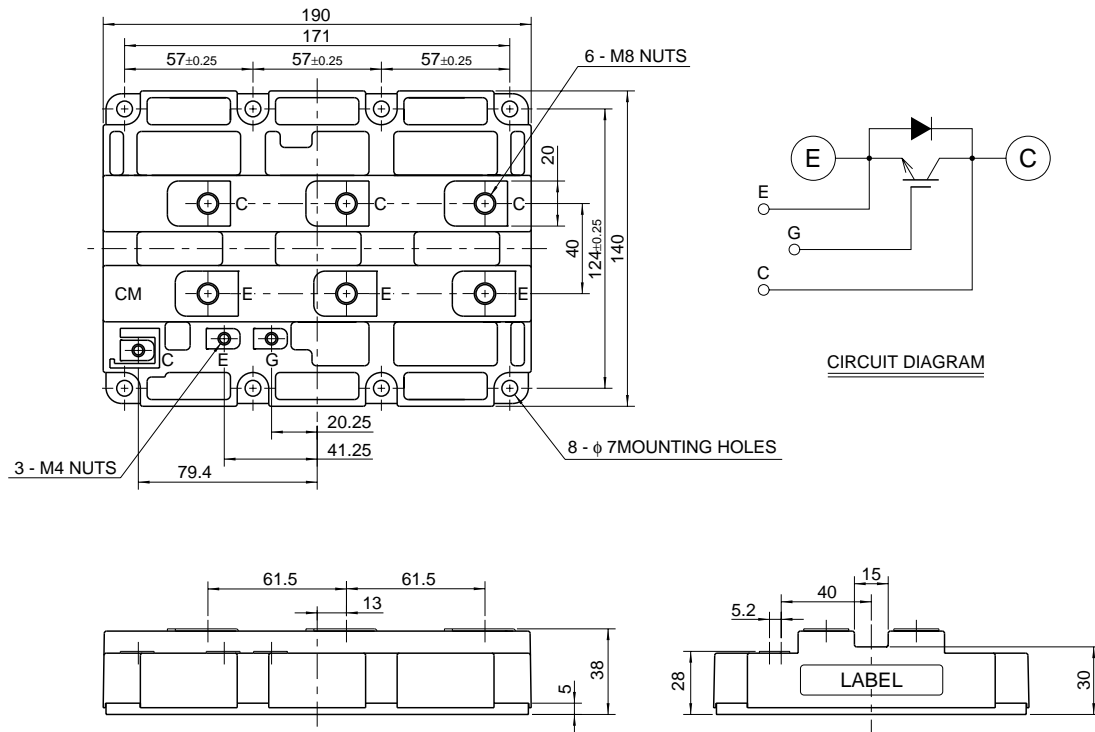

HVIGBT MODULES (High Voltage Insulated Gate Bipolar Transistor Modules)

Mar. 2003

**CM1200HA-50H**

**HIGH POWER SWITCHING USE  
INSULATED TYPE**

HVIGBT (High Voltage Insulated Gate Bipolar Transistor) Modules

**MAXIMUM RATINGS (Tj = 25°C)**

Symbol	Item	Conditions	Ratings	Unit
V <sub>CE</sub> S	Collector-emitter voltage	V <sub>GE</sub> = 0V	2500	V
V <sub>GE</sub> S	Gate-emitter voltage	V <sub>CE</sub> = 0V	±20	V
I <sub>C</sub>	Collector current	DC, T <sub>C</sub> = 80°C	1200	A
I <sub>CM</sub>		Pulse (Note 1)	2400	A
I <sub>E</sub> (Note 2)	Emitter current		1200	A
I <sub>EM</sub> (Note 2)		Pulse (Note 1)	2400	A
P <sub>C</sub> (Note 3)	Maximum collector dissipation	T <sub>C</sub> = 25°C, IGBT part	10400	W
T <sub>j</sub>	Junction temperature	—	-40 ~ +150	°C
T <sub>stg</sub>	Storage temperature	—	-40 ~ +125	°C
V <sub>iso</sub>	Isolation voltage	Charged part to base plate, rms, sinusoidal, AC 60Hz 1min.	6000	V
—	Mounting torque	Main terminals screw M8	6.67 ~ 13.00	N·m
		Mounting screw M6	2.84 ~ 6.00	N·m
		Auxiliary terminals screw M4	0.88 ~ 2.00	N·m
—	Mass	Typical value	2.2	kg

**ELECTRICAL CHARACTERISTICS (Tj = 25°C)**

Symbol	Item	Conditions	Limits			Unit
			Min	Typ	Max	
I <sub>CE</sub> S	Collector cutoff current	V <sub>CE</sub> = V <sub>CE</sub> S, V <sub>GE</sub> = 0V	—	—	15	mA
V <sub>GE(th)</sub>	Gate-emitter threshold voltage	I <sub>C</sub> = 120mA, V <sub>CE</sub> = 10V	4.5	6.0	7.5	V
I <sub>GE</sub> S	Gate-leakage current	V <sub>GE</sub> = V <sub>GE</sub> S, V <sub>CE</sub> = 0V	—	—	0.5	µA
V <sub>CE(sat)</sub>	Collector-emitter saturation voltage	T <sub>j</sub> = 25°C	—	3.20	4.16	V
		T <sub>j</sub> = 125°C	—	3.60	—	
C <sub>ies</sub>	Input capacitance	V <sub>CE</sub> = 10V V <sub>GE</sub> = 0V	—	120	—	nF
C <sub>oes</sub>	Output capacitance		—	13.2	—	nF
C <sub>res</sub>	Reverse transfer capacitance		—	4.0	—	nF
Q <sub>G</sub>	Total gate charge	V <sub>CC</sub> = 1250V, I <sub>C</sub> = 1200A, V <sub>GE</sub> = 15V	—	5.4	—	µC
t <sub>d(on)</sub>	Turn-on delay time	V <sub>CC</sub> = 1250V, I <sub>C</sub> = 1200A	—	—	1.60	µs
t <sub>r</sub>	Turn-on rise time	V <sub>GE1</sub> = V <sub>GE2</sub> = 15V	—	—	2.00	µs
t <sub>d(off)</sub>	Turn-off delay time	R <sub>G</sub> = 2.5Ω	—	—	2.50	µs
t <sub>f</sub>	Turn-off fall time	Resistive load switching operation	—	—	1.00	µs
V <sub>EC</sub> (Note 2)	Emitter-collector voltage	I <sub>E</sub> = 1200A, V <sub>GE</sub> = 0V	—	2.90	3.77	V
t <sub>rr</sub> (Note 2)	Reverse recovery time	I <sub>E</sub> = 1200A	—	—	1.20	µs
Q <sub>rr</sub> (Note 2)	Reverse recovery charge	die / dt = -2400A / µs	—	250	—	µC
R <sub>th(j-c)Q</sub>	Thermal resistance	Junction to case, IGBT part	—	—	0.012	K/W
R <sub>th(j-c)R</sub>		Junction to case, FWDi part	—	—	0.024	K/W
R <sub>th(c-f)</sub>	Contact thermal resistance	Case to fin, conductive grease applied	—	0.006	—	K/W

- Note 1. Pulse width and repetition rate should be such that the device junction temp. (T<sub>j</sub>) does not exceed T<sub>jmax</sub> rating.  
 2. I<sub>E</sub>, V<sub>EC</sub>, t<sub>rr</sub>, Q<sub>rr</sub> & die/dt represent characteristics of the anti-parallel, emitter to collector free-wheel diode.  
 3. Junction temperature (T<sub>j</sub>) should not increase beyond 150°C.  
 4. Pulse width and repetition rate should be such as to cause negligible temperature rise.

# CM1200HA-50H

HIGH POWER SWITCHING USE  
INSULATED TYPE

HVIGBT (High Voltage Insulated Gate Bipolar Transistor) Modules

## PERFORMANCE CURVES

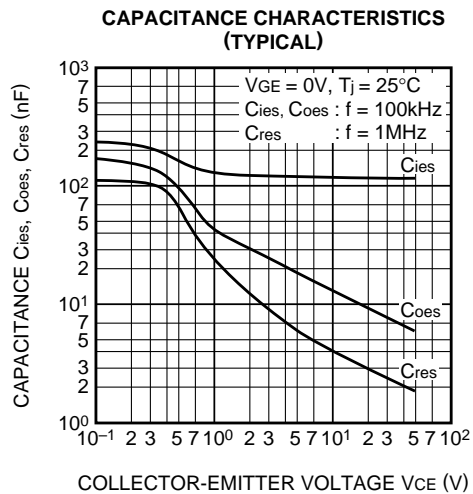
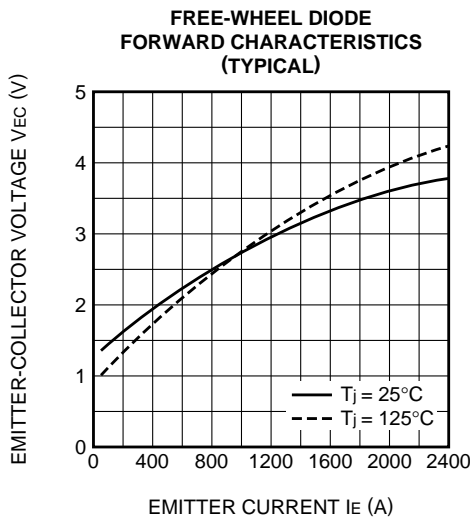
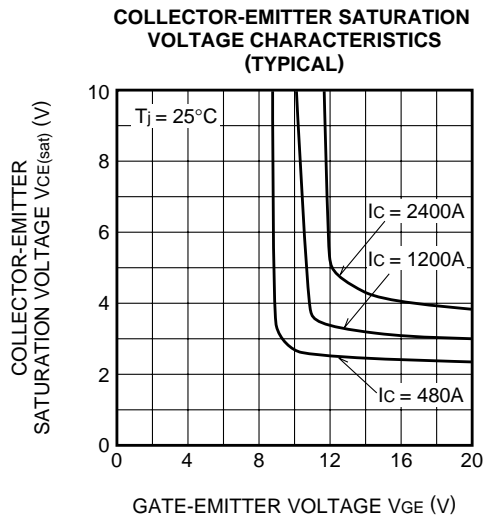
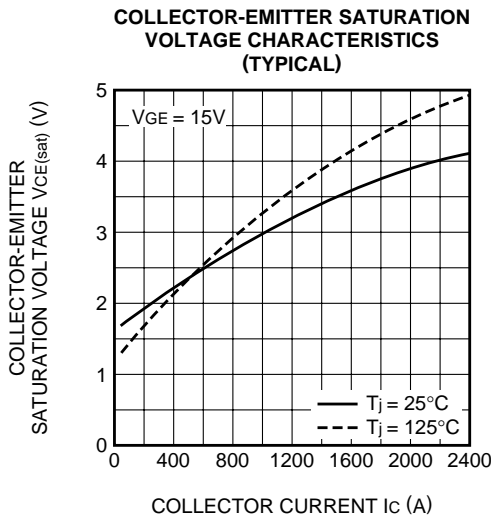
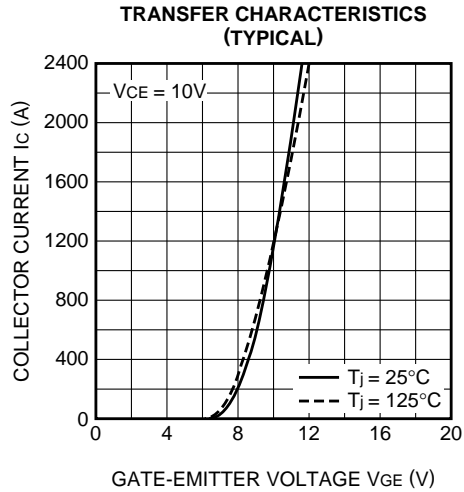
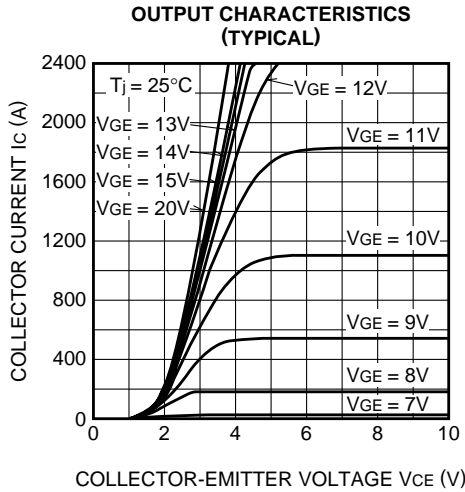

# CM1200HA-50H

HIGH POWER SWITCHING USE  
INSULATED TYPE

HVIGBT (High Voltage Insulated Gate Bipolar Transistor) Modules

**HALF-BRIDGE  
SWITCHING TIME CHARACTERISTICS  
(TYPICAL)**

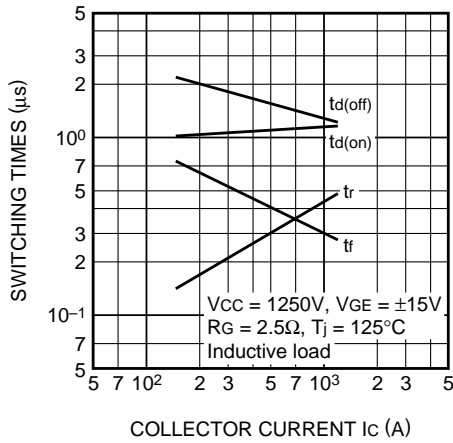

**REVERSE RECOVERY CHARACTERISTICS  
OF FREE-WHEEL DIODE  
(TYPICAL)**

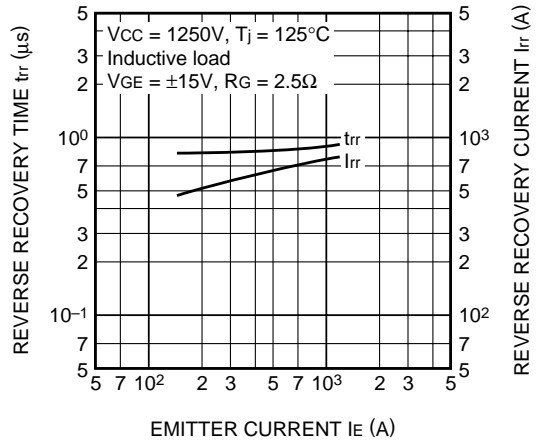

**HALF-BRIDGE  
SWITCHING ENERGY CHARACTERISTICS  
(TYPICAL)**

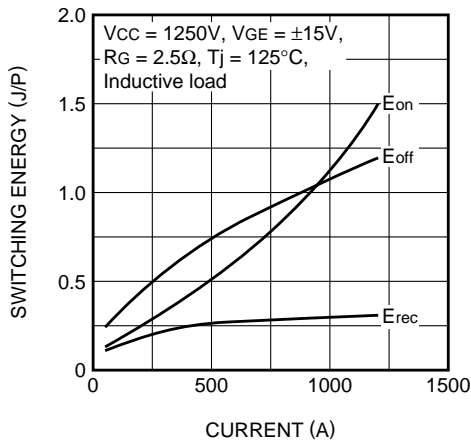

**HALF-BRIDGE  
SWITCHING ENERGY CHARACTERISTICS  
(TYPICAL)**

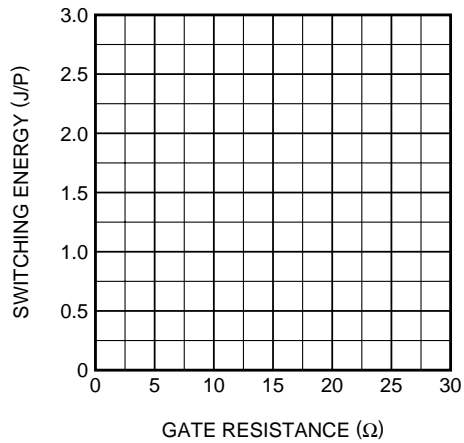

**GATE CHARGE CHARACTERISTICS  
(TYPICAL)**

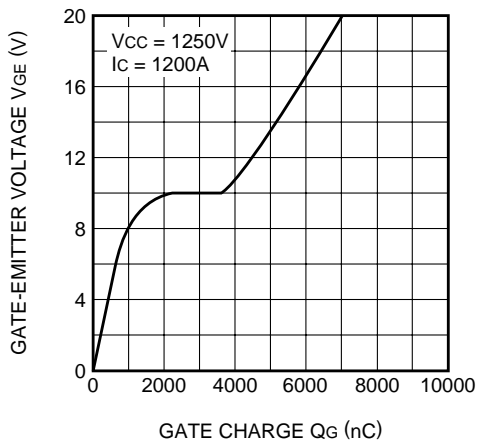

**TRANSIENT THERMAL  
IMPEDANCE CHARACTERISTICS**

