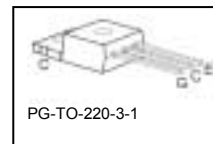
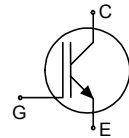


## Fast IGBT in NPT-technology

- lower  $E_{off}$  compared to previous generation
- Short circuit withstand time – 10  $\mu$ s
- Designed for:
  - Motor controls
  - Inverter
  - SMPS
- NPT-Technology offers:
  - very tight parameter distribution
  - high ruggedness, temperature stable behaviour
  - parallel switching capability



- Qualified according to JEDEC<sup>1</sup> for target applications
- Pb-free lead plating; RoHS compliant
- Complete product spectrum and PSpice Models : <http://www.infineon.com/igbt/>

| Type      | $V_{CE}$ | $I_C$ | $E_{off}$ | $T_j$ | Marking  | Package       |
|-----------|----------|-------|-----------|-------|----------|---------------|
| SGP07N120 | 1200V    | 8A    | 0.7mJ     | 150°C | GP07N120 | PG-TO-220-3-1 |

### Maximum Ratings

| Parameter   | Symbol         | Value      | Unit             |
|---|----------------|------------|------------------|
| Collector-emitter voltage   | $V_{CE}$       | 1200       | V                |
| DC collector current  | $I_C$          | 16.5       | A                |
| $T_C = 25^\circ\text{C}$  |                | 7.9        |                  |
| $T_C = 100^\circ\text{C}$   |                |            |                  |
| Pulsed collector current, $t_p$ limited by $T_{jmax}$   | $I_{Cpuls}$    | 27         |                  |
| Turn off safe operating area  | -              | 27         |                  |
| $V_{CE} \leq 1200\text{V}, T_j \leq 150^\circ\text{C}$  |                |            |                  |
| Gate-emitter voltage  | $V_{GE}$       | $\pm 20$   | V                |
| Avalanche energy, single pulse  | $E_{AS}$       | 40         | mJ               |
| $I_C = 8\text{A}, V_{CC} = 50\text{V}, R_{GE} = 25\Omega$ , start at $T_j = 25^\circ\text{C}$ |                |            |                  |
| Short circuit withstand time <sup>2</sup>   | $t_{SC}$       | 10         | $\mu$ s          |
| $V_{GE} = 15\text{V}, 100\text{V} \leq V_{CC} \leq 1200\text{V}, T_j \leq 150^\circ\text{C}$  |                |            |                  |
| Power dissipation   | $P_{tot}$      | 125        | W                |
| $T_C = 25^\circ\text{C}$  |                |            |                  |
| Operating junction and storage temperature  | $T_j, T_{stg}$ | -55...+150 | $^\circ\text{C}$ |
| Soldering temperature, 1.6mm (0.063 in.) from case for 10s                                    | -              | 260        |                  |

<sup>1</sup> J-STD-020 and JESD-022

<sup>2</sup> Allowed number of short circuits: <1000; time between short circuits: >1s.

**Thermal Resistance**

| Parameter                                | Symbol     | Conditions    | Max. Value | Unit |
|--|------------|---------------|------------|------|
| <b>Characteristic</b>                    |            |               |            |      |
| IGBT thermal resistance, junction – case | $R_{thJC}$ |               | 1          | K/W  |
| Thermal resistance, junction – ambient   | $R_{thJA}$ | PG-TO-220-3-1 | 62         |      |

**Electrical Characteristic, at  $T_j = 25\text{ }^\circ\text{C}$ , unless otherwise specified**

| Parameter  | Symbol        | Conditions  | Value |      |      | Unit    |
|--|---------------|---|-------|------|------|---------|
|  |               |   | min.  | typ. | max. |         |
| <b>Static Characteristic</b>                                   |               |   |       |      |      |         |
| Collector-emitter breakdown voltage                            | $V_{(BR)CES}$ | $V_{GE}=0V, I_C=500\mu A$   | 1200  | -    | -    | V       |
| Collector-emitter saturation voltage                           | $V_{CE(sat)}$ | $V_{GE} = 15V, I_C=8A$<br>$T_j=25^\circ C$<br>$T_j=150^\circ C$                           | 2.5   | 3.1  | 3.6  |         |
|  |               |   | -     | 3.7  | 4.3  |         |
| Gate-emitter threshold voltage                                 | $V_{GE(th)}$  | $I_C=350\mu A, V_{CE}=V_{GE}$   | 3     | 4    | 5    |         |
| Zero gate voltage collector current                            | $I_{CES}$     | $V_{CE}=1200V, V_{GE}=0V$<br>$T_j=25^\circ C$<br>$T_j=150^\circ C$                        | -     | -    | 100  | $\mu A$ |
|  |               |   | -     | -    | 400  |         |
| Gate-emitter leakage current                                   | $I_{GES}$     | $V_{CE}=0V, V_{GE}=20V$   | -     | -    | 100  | nA      |
| Transconductance   | $g_{fs}$      | $V_{CE}=20V, I_C=8A$  |       | 6    | -    | S       |
| <b>Dynamic Characteristic</b>                                  |               |   |       |      |      |         |
| Input capacitance  | $C_{iss}$     | $V_{CE}=25V,$<br>$V_{GE}=0V,$<br>$f=1MHz$   | -     | 720  | 870  | pF      |
| Output capacitance   | $C_{oss}$     |   | -     | 60   | 75   |         |
| Reverse transfer capacitance                                   | $C_{riss}$    |   | -     | 40   | 50   |         |
| Gate charge  | $Q_{Gate}$    | $V_{CC}=960V, I_C=8A$<br>$V_{GE}=15V$   | -     | 70   | 90   | nC      |
| Internal emitter inductance measured 5mm (0.197 in.) from case | $L_E$         |   | -     | 7    | -    | nH      |
| Short circuit collector current <sup>2)</sup>                  | $I_{C(SC)}$   | $V_{GE}=15V, t_{SC}\leq 10\mu s$<br>$100V\leq V_{CC}\leq 1200V,$<br>$T_j\leq 150^\circ C$ | -     | 75   | -    | A       |

<sup>2)</sup> Allowed number of short circuits: <1000; time between short circuits: >1s.

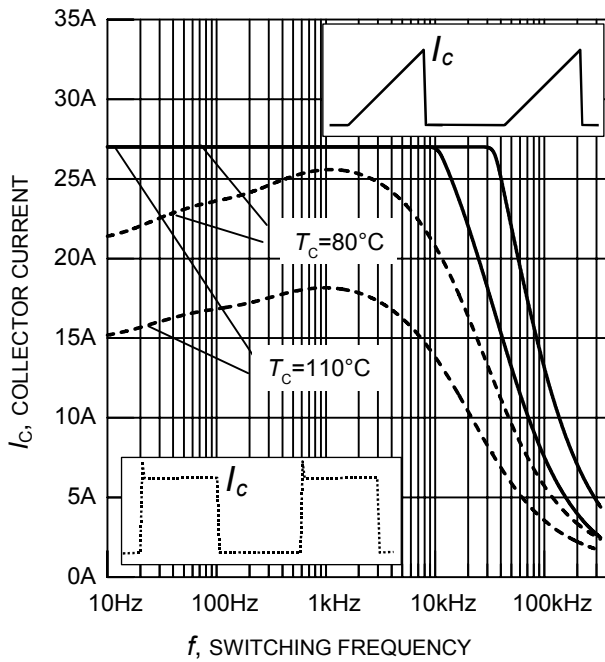
### Switching Characteristic, Inductive Load, at $T_j=25\text{ }^\circ\text{C}$

| Parameter                  | Symbol       | Conditions   | Value |      |      | Unit |
|----------------------------|--------------|--|-------|------|------|------|
|                            |              |  | min.  | typ. | max. |      |
| <b>IGBT Characteristic</b> |              |  |       |      |      |      |
| Turn-on delay time         | $t_{d(on)}$  | $T_j=25\text{ }^\circ\text{C}$ ,<br>$V_{CC}=800\text{V}$ , $I_C=8\text{A}$ ,<br>$V_{GE}=15\text{V}/0\text{V}$ ,<br>$R_G=47\Omega$ ,<br>$L_\sigma^{(1)}=180\text{nH}$ ,<br>$C_\sigma^{(1)}=40\text{pF}$<br>Energy losses include<br>"tail" and diode<br>reverse recovery. | -     | 27   | 35   | ns   |
| Rise time                  | $t_r$        |  | -     | 29   | 38   |      |
| Turn-off delay time        | $t_{d(off)}$ |  | -     | 440  | 570  |      |
| Fall time                  | $t_f$        |  | -     | 21   | 27   |      |
| Turn-on energy             | $E_{on}$     |  | -     | 0.6  | 0.8  | mJ   |
| Turn-off energy            | $E_{off}$    |  | -     | 0.4  | 0.55 |      |
| Total switching energy     | $E_{ts}$     |  | -     | 1.0  | 1.35 |      |

### Switching Characteristic, Inductive Load, at $T_j=150\text{ }^\circ\text{C}$

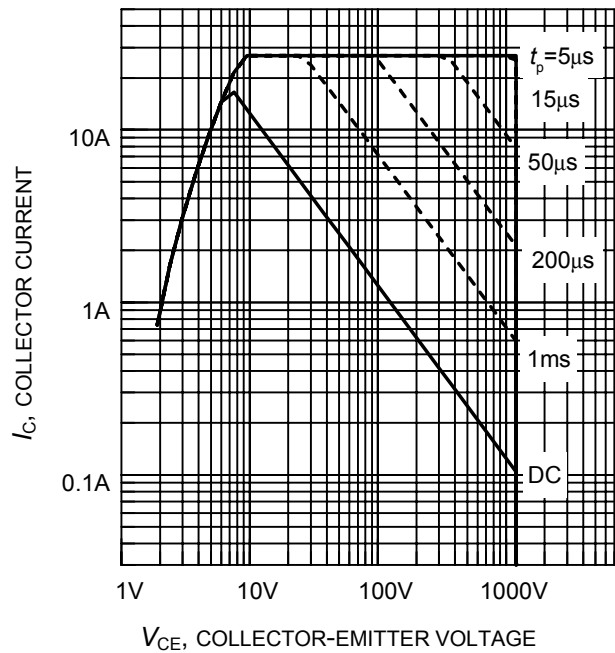
| Parameter                  | Symbol       | Conditions   | Value |      |      | Unit |
|----------------------------|--------------|--|-------|------|------|------|
|                            |              |  | min.  | typ. | max. |      |
| <b>IGBT Characteristic</b> |              |  |       |      |      |      |
| Turn-on delay time         | $t_{d(on)}$  | $T_j=150\text{ }^\circ\text{C}$<br>$V_{CC}=800\text{V}$ ,<br>$I_C=8\text{A}$ ,<br>$V_{GE}=15\text{V}/0\text{V}$ ,<br>$R_G=47\Omega$ ,<br>$L_\sigma^{(1)}=180\text{nH}$ ,<br>$C_\sigma^{(1)}=40\text{pF}$<br>Energy losses include<br>"tail" and diode<br>reverse recovery. | -     | 30   | 36   | ns   |
| Rise time                  | $t_r$        |  | -     | 26   | 31   |      |
| Turn-off delay time        | $t_{d(off)}$ |  | -     | 490  | 590  |      |
| Fall time                  | $t_f$        |  | -     | 30   | 36   |      |
| Turn-on energy             | $E_{on}$     |  | -     | 1.0  | 1.2  | mJ   |
| Turn-off energy            | $E_{off}$    |  | -     | 0.7  | 0.9  |      |
| Total switching energy     | $E_{ts}$     |  | -     | 1.7  | 2.1  |      |

<sup>1)</sup> Leakage inductance  $L_\sigma$  and stray capacity  $C_\sigma$  due to dynamic test circuit in figure E.



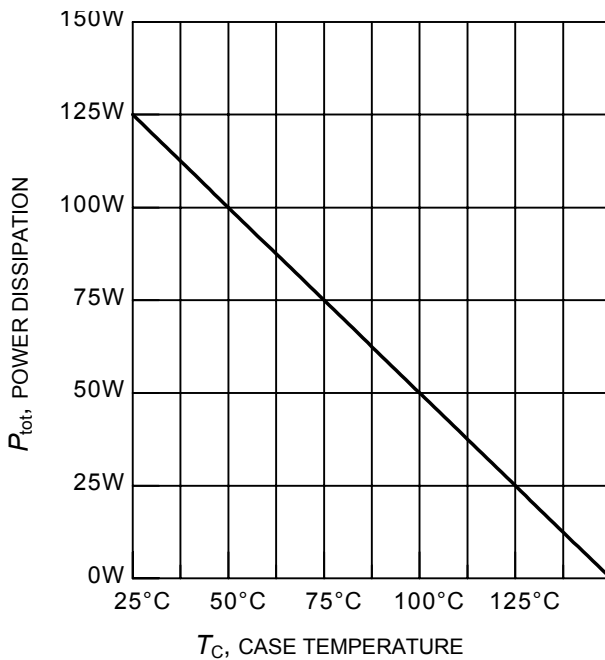
**Figure 1. Collector current as a function of switching frequency**

( $T_j \leq 150^\circ\text{C}$ ,  $D = 0.5$ ,  $V_{CE} = 800\text{V}$ ,  $V_{GE} = +15\text{V}/0\text{V}$ ,  $R_G = 47\Omega$ )



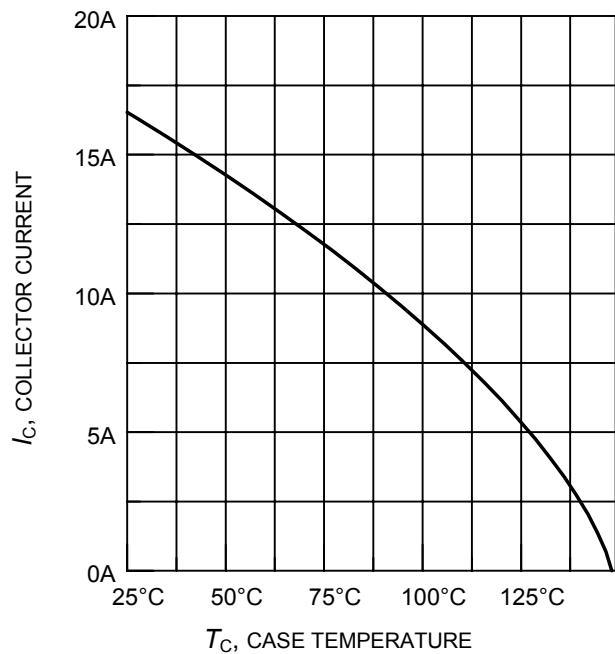
**Figure 2. Safe operating area**

( $D = 0$ ,  $T_C = 25^\circ\text{C}$ ,  $T_j \leq 150^\circ\text{C}$ )



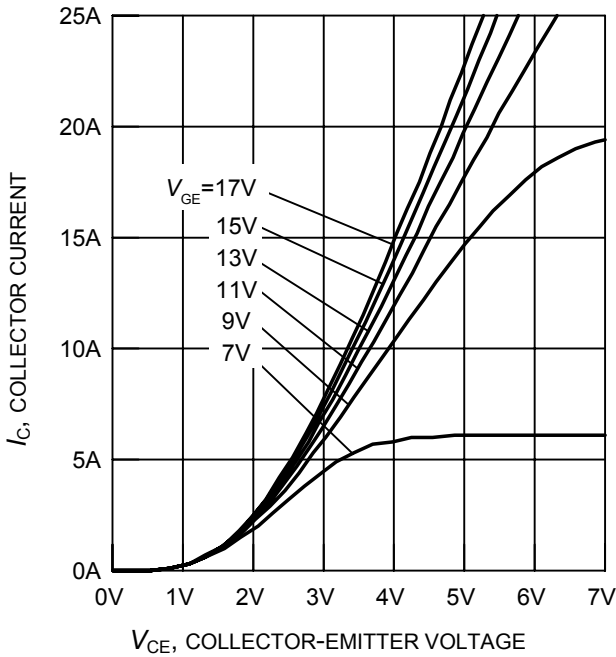
**Figure 3. Power dissipation as a function of case temperature**

( $T_j \leq 150^\circ\text{C}$ )

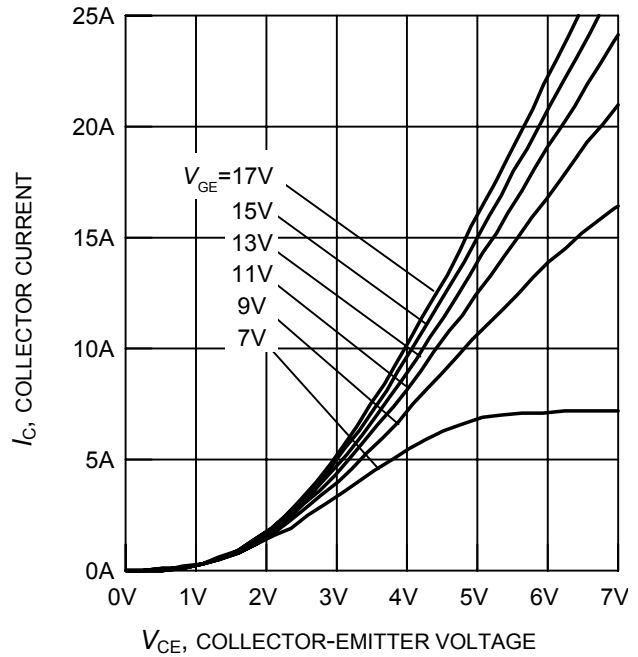


**Figure 4. Collector current as a function of case temperature**

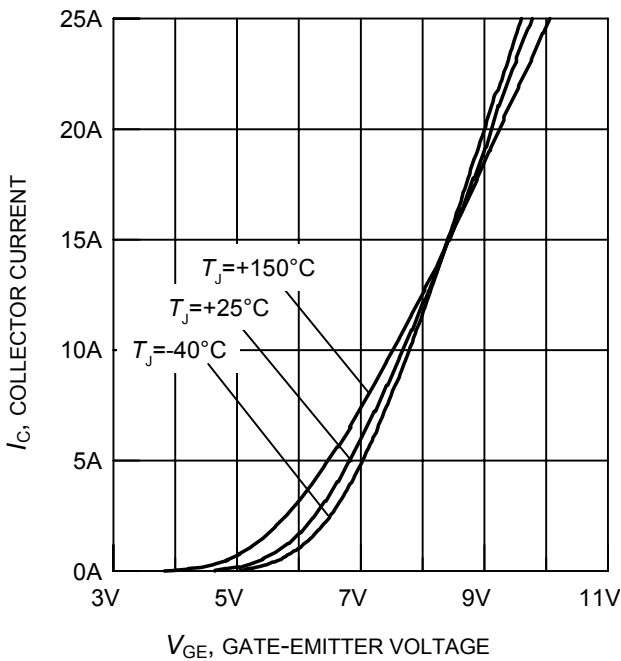
( $V_{GE} \leq 15\text{V}$ ,  $T_j \leq 150^\circ\text{C}$ )



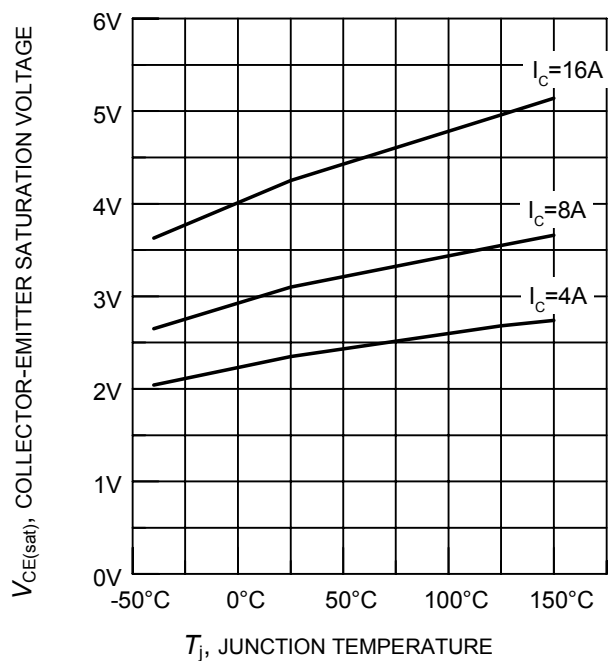
**Figure 5. Typical output characteristics**  
( $T_j = 25^\circ\text{C}$ )



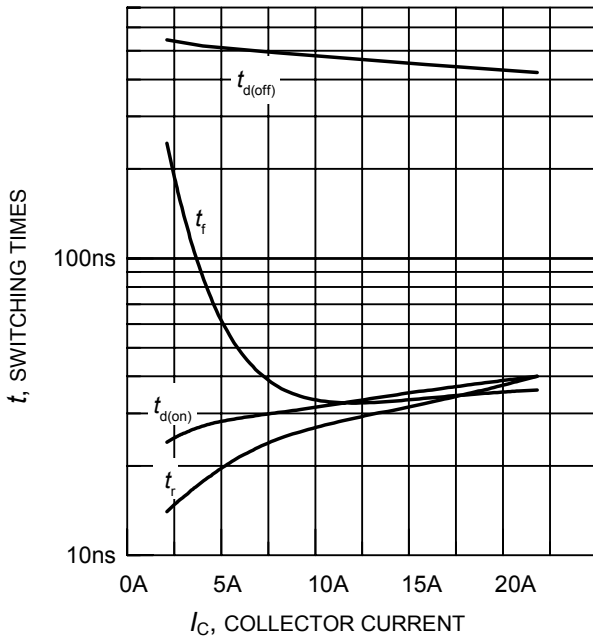
**Figure 6. Typical output characteristics**  
( $T_j = 150^\circ\text{C}$ )



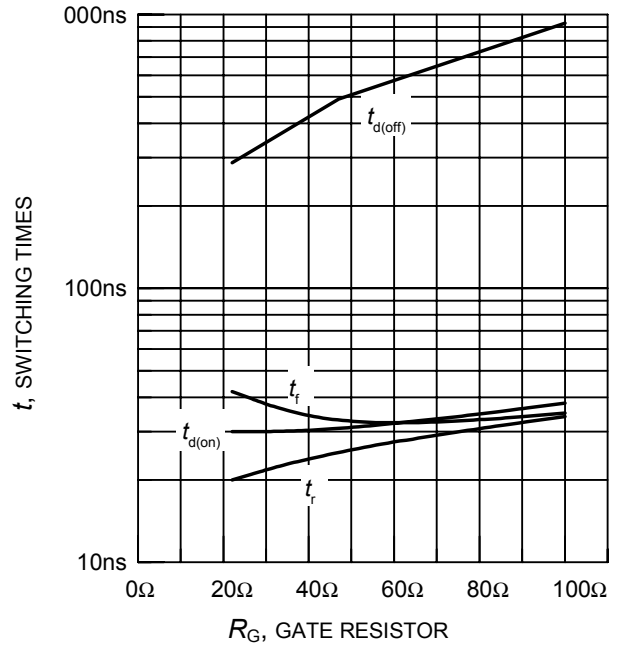
**Figure 7. Typical transfer characteristics**  
( $V_{CE} = 20\text{V}$ )



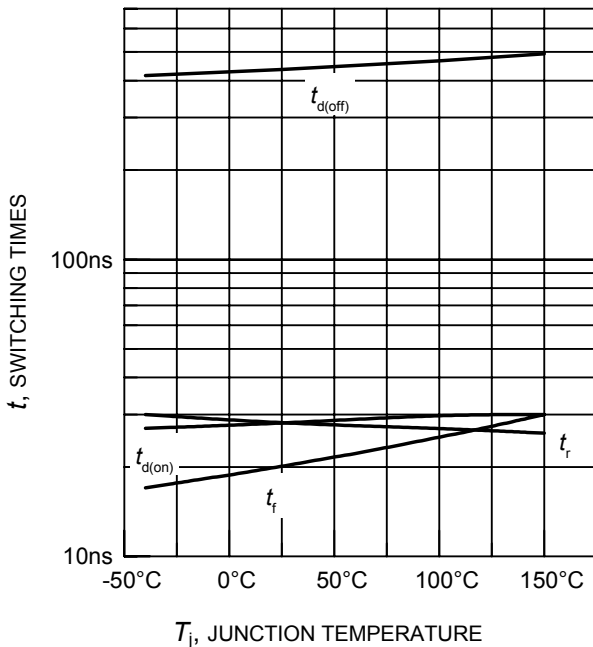
**Figure 8. Typical collector-emitter saturation voltage as a function of junction temperature**  
( $V_{GE} = 15\text{V}$ )



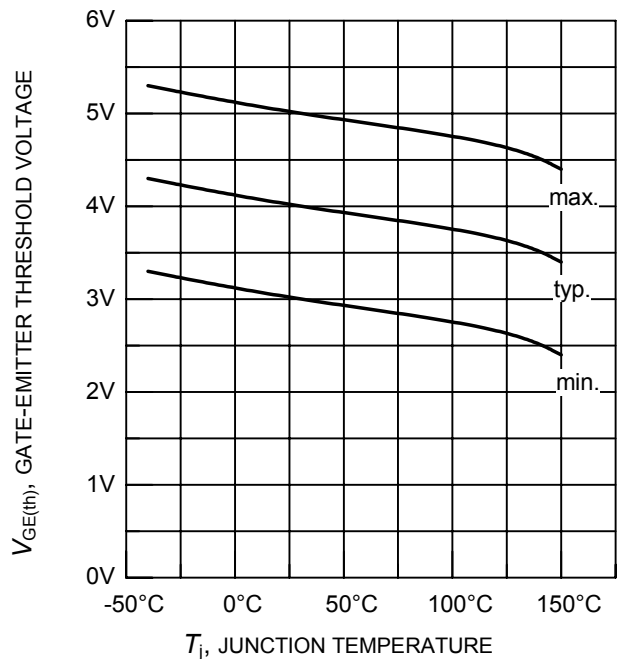
**Figure 9. Typical switching times as a function of collector current**  
 (inductive load,  $T_j = 150^\circ\text{C}$ ,  
 $V_{CE} = 800\text{V}$ ,  $V_{GE} = +15\text{V}/0\text{V}$ ,  $R_G = 47\Omega$ ,  
 dynamic test circuit in Fig.E )



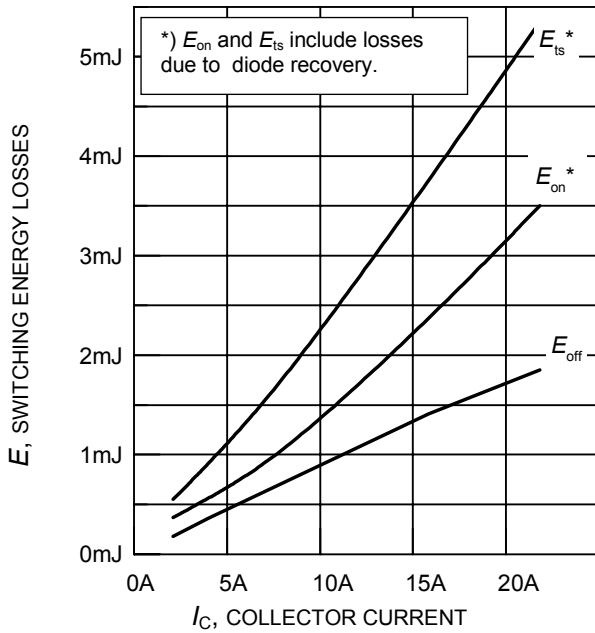
**Figure 10. Typical switching times as a function of gate resistor**  
 (inductive load,  $T_j = 150^\circ\text{C}$ ,  
 $V_{CE} = 800\text{V}$ ,  $V_{GE} = +15\text{V}/0\text{V}$ ,  $I_C = 8\text{A}$ ,  
 dynamic test circuit in Fig.E )



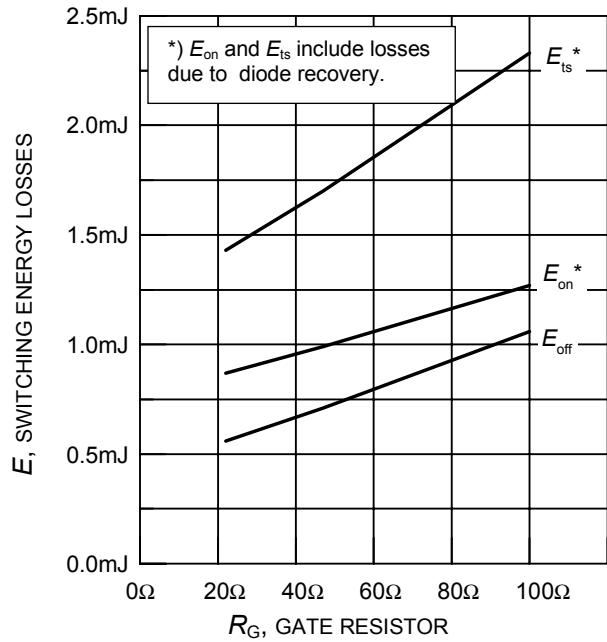
**Figure 11. Typical switching times as a function of junction temperature**  
 (inductive load,  $V_{CE} = 800\text{V}$ ,  
 $V_{GE} = +15\text{V}/0\text{V}$ ,  $I_C = 8\text{A}$ ,  $R_G = 47\Omega$ ,  
 dynamic test circuit in Fig.E )



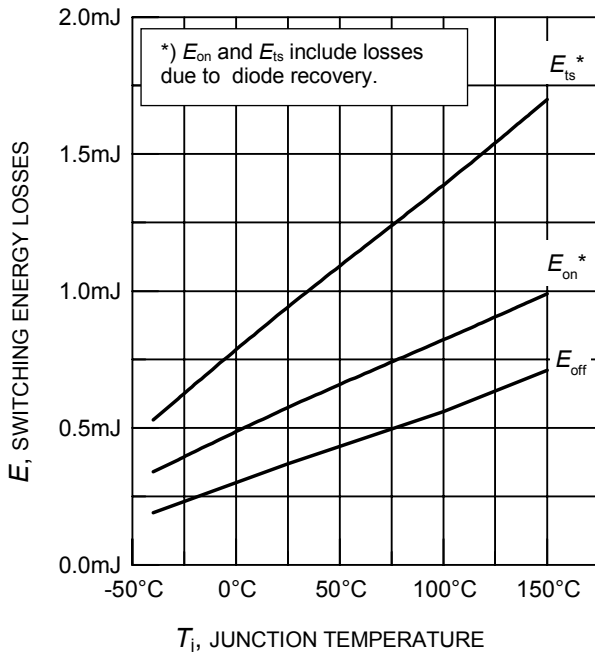
**Figure 12. Gate-emitter threshold voltage as a function of junction temperature**  
 ( $I_C = 0.3\text{mA}$ )



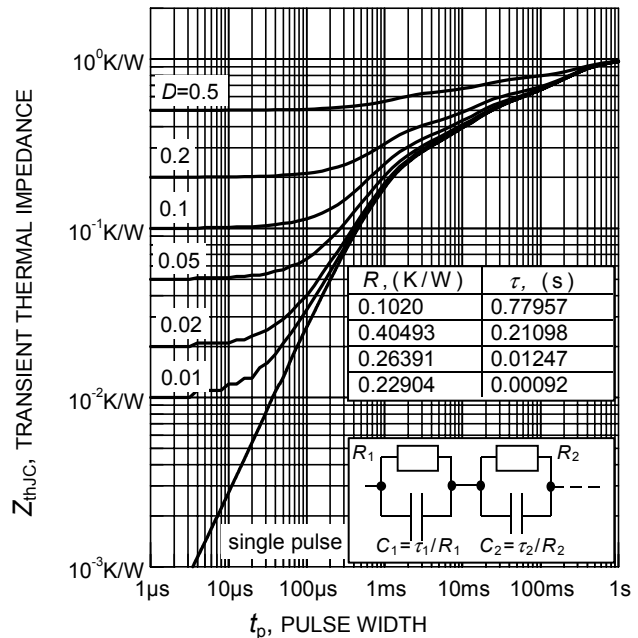
**Figure 13. Typical switching energy losses as a function of collector current** (inductive load,  $T_j = 150^\circ\text{C}$ ,  $V_{CE} = 800\text{V}$ ,  $V_{GE} = +15\text{V}/0\text{V}$ ,  $R_G = 47\ \Omega$ , dynamic test circuit in Fig.E )



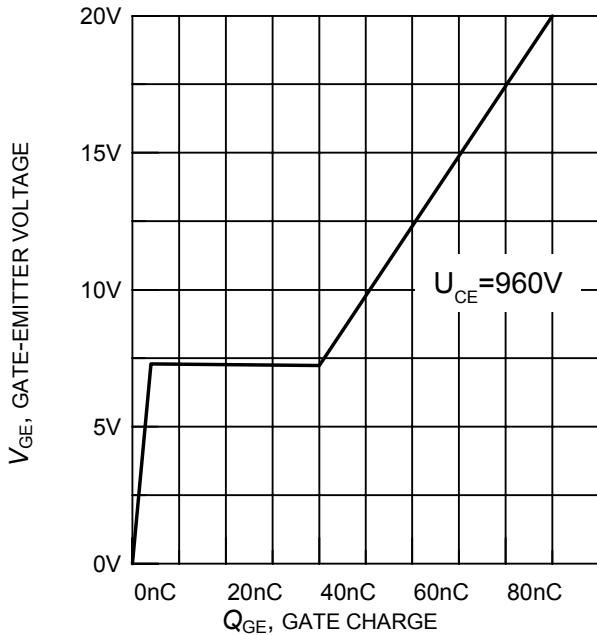
**Figure 14. Typical switching energy losses as a function of gate resistor** (inductive load,  $T_j = 150^\circ\text{C}$ ,  $V_{CE} = 800\text{V}$ ,  $V_{GE} = +15\text{V}/0\text{V}$ ,  $I_C = 8\text{A}$ , dynamic test circuit in Fig.E )



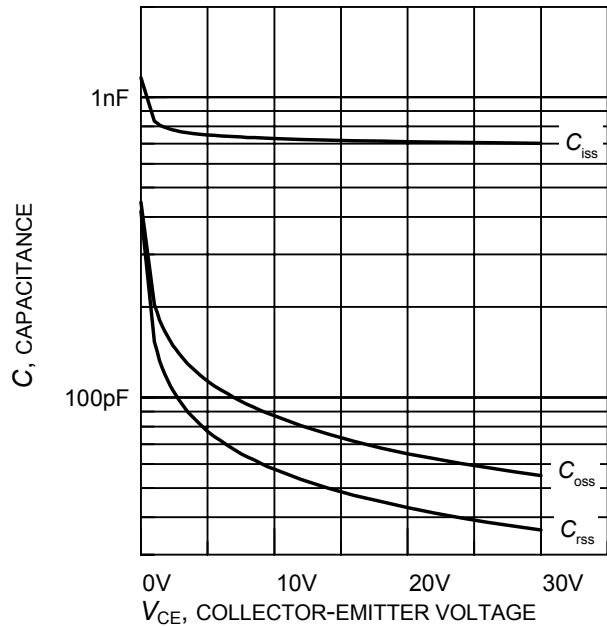
**Figure 15. Typical switching energy losses as a function of junction temperature** (inductive load,  $V_{CE} = 800\text{V}$ ,  $V_{GE} = +15\text{V}/0\text{V}$ ,  $I_C = 8\text{A}$ ,  $R_G = 47\ \Omega$ , dynamic test circuit in Fig.E )



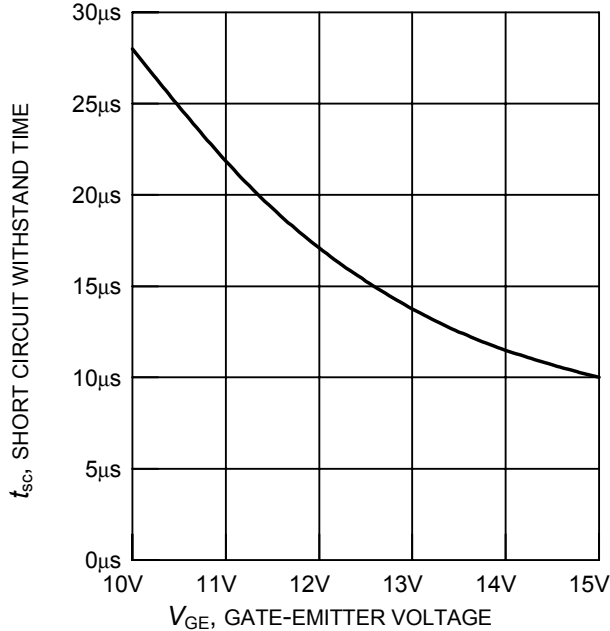
**Figure 16. IGBT transient thermal impedance as a function of pulse width** ( $D = t_p / T$ )



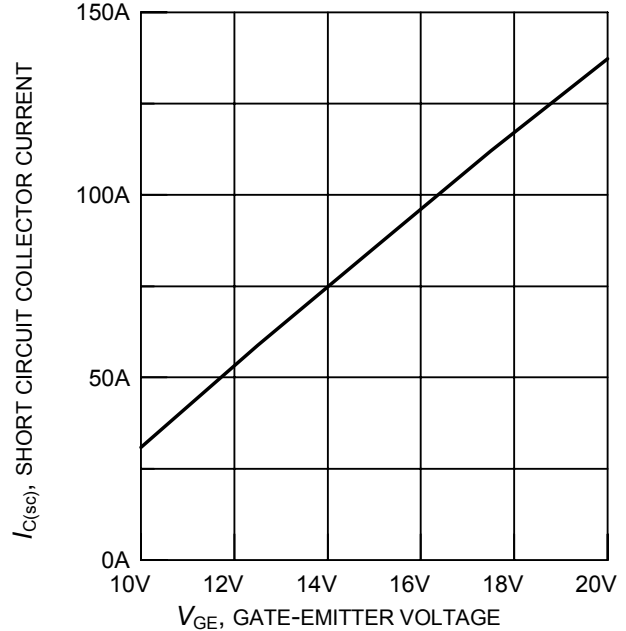
**Figure 17. Typical gate charge**  
( $I_C = 8A$ )



**Figure 18. Typical capacitance as a function of collector-emitter voltage**  
( $V_{GE} = 0V, f = 1MHz$ )



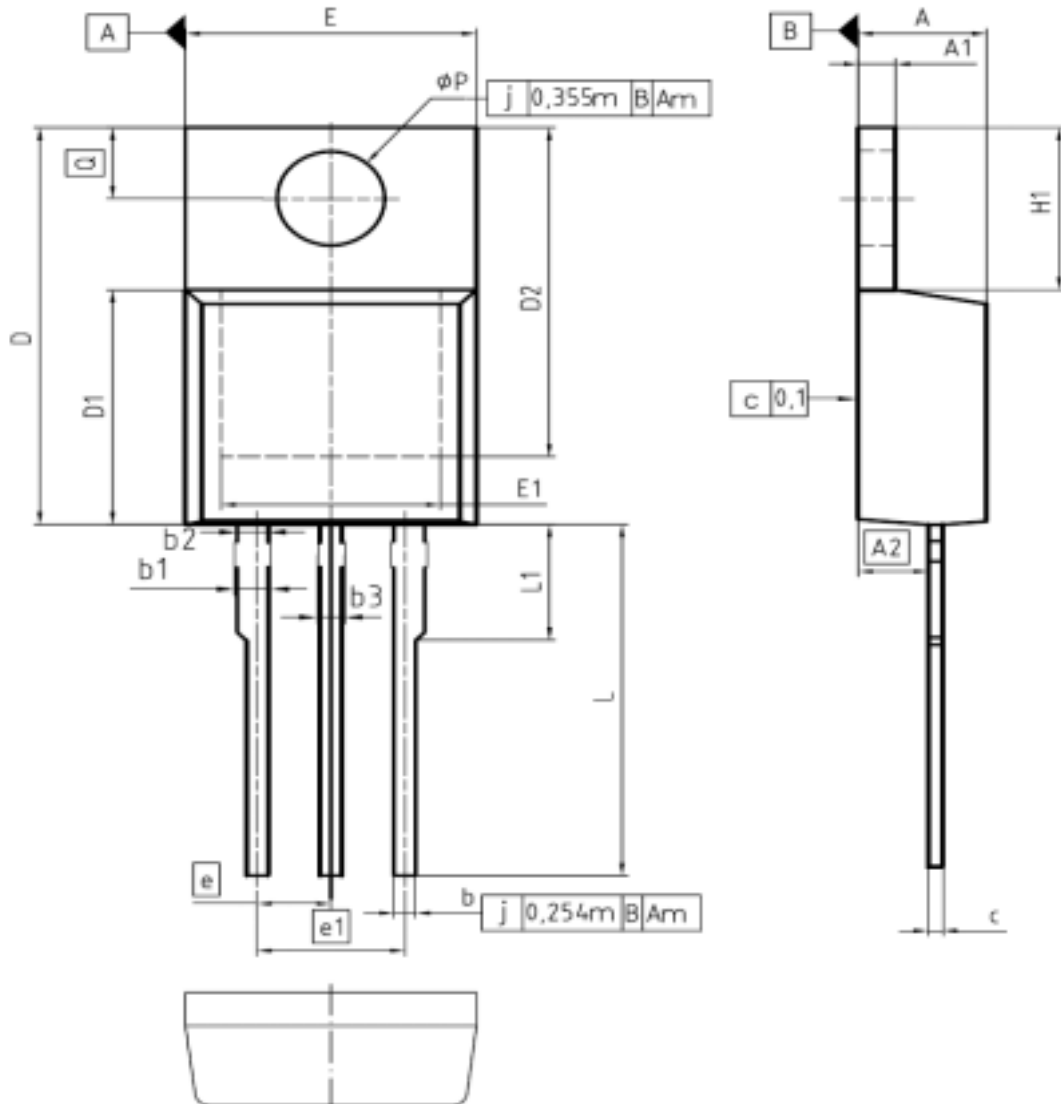
**Figure 19. Short circuit withstand time as a function of gate-emitter voltage**  
( $V_{CE} = 1200V, \text{start at } T_j = 25^\circ C$ )



**Figure 20. Typical short circuit collector current as a function of gate-emitter voltage**  
( $100V \leq V_{CE} \leq 1200V, T_C = 25^\circ C, T_j \leq 150^\circ C$ )



PG-TO220-3-1



| DIM      | MILLIMETERS |       | INCHES |       |
|----------|-------------|-------|--------|-------|
|          | MIN         | MAX   | MIN    | MAX   |
| A        | 4.30        | 4.57  | 0.169  | 0.180 |
| A1       | 1.17        | 1.40  | 0.046  | 0.055 |
| A2       | 2.15        | 2.72  | 0.085  | 0.107 |
| b        | 0.65        | 0.86  | 0.026  | 0.034 |
| b1       | 0.95        | 1.40  | 0.037  | 0.055 |
| b2       | 0.95        | 1.15  | 0.037  | 0.045 |
| b3       | 0.65        | 1.15  | 0.026  | 0.045 |
| c        | 0.33        | 0.60  | 0.013  | 0.024 |
| D        | 14.81       | 15.95 | 0.583  | 0.628 |
| D1       | 8.51        | 9.45  | 0.335  | 0.372 |
| D2       | 12.19       | 13.10 | 0.480  | 0.516 |
| E        | 9.70        | 10.36 | 0.382  | 0.408 |
| E1       | 6.50        | 8.60  | 0.256  | 0.339 |
| e        | 2.54        |       | 0.100  |       |
| e1       | 5.08        |       | 0.200  |       |
| N        | 3           |       | 3      |       |
| H1       | 5.90        | 6.90  | 0.232  | 0.272 |
| L        | 13.00       | 14.00 | 0.512  | 0.551 |
| L1       | -           | 4.80  | -      | 0.189 |
| $\phi P$ | 3.60        | 3.89  | 0.142  | 0.153 |
| Q        | 2.60        | 3.00  | 0.102  | 0.118 |

DOCUMENT NO.  
Z8B00003318

SCALE 0 2.5 5mm

EUROPEAN PROJECTION

ISSUE DATE  
23-08-2007

REVISION  
05

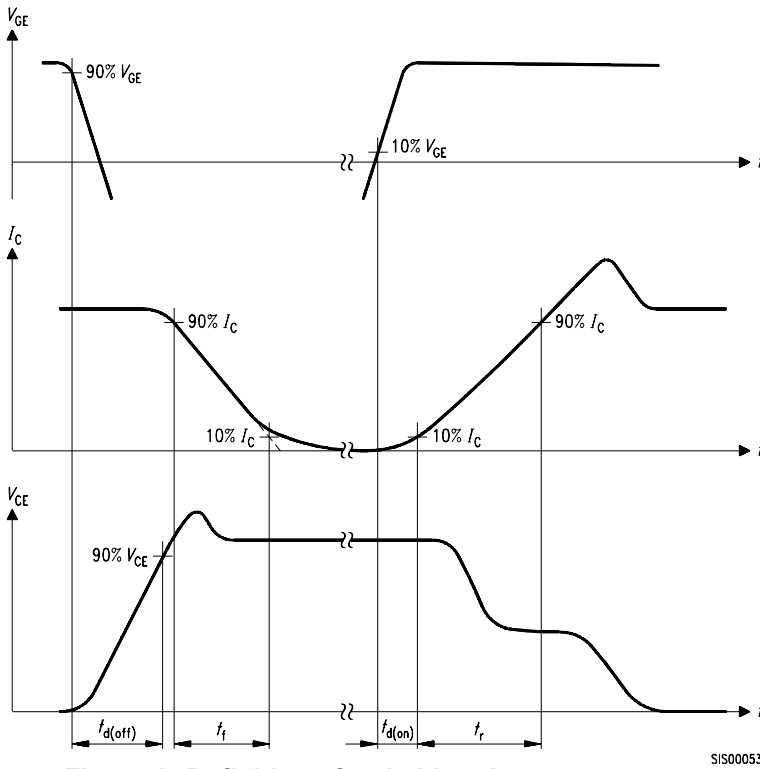


Figure A. Definition of switching times

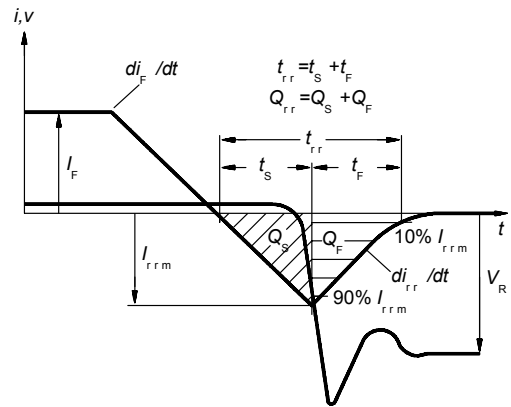


Figure C. Definition of diodes switching characteristics

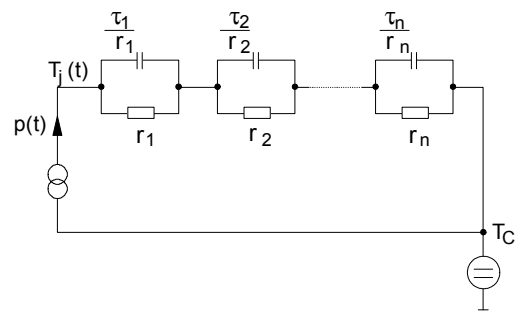


Figure D. Thermal equivalent circuit

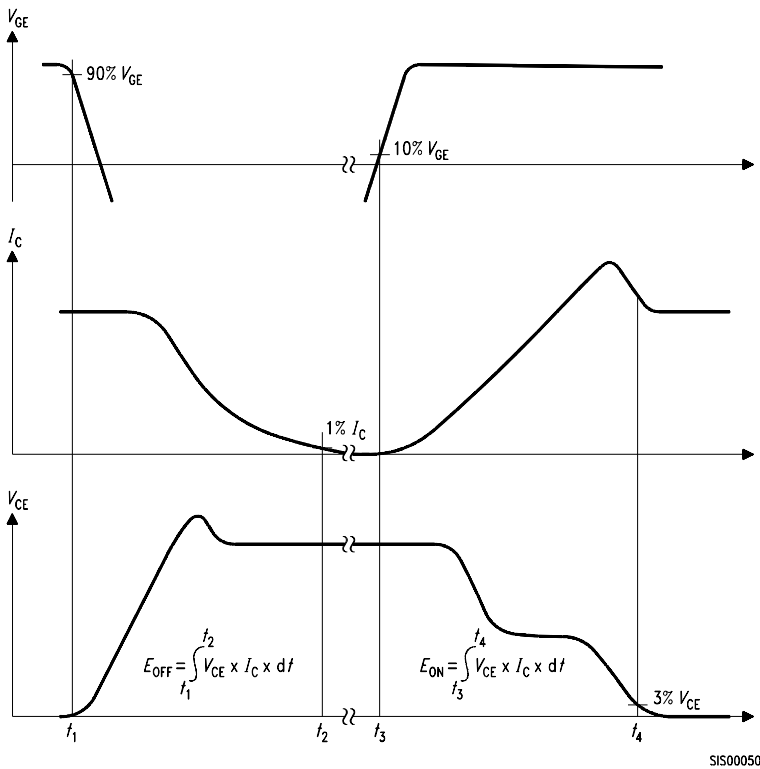


Figure B. Definition of switching losses

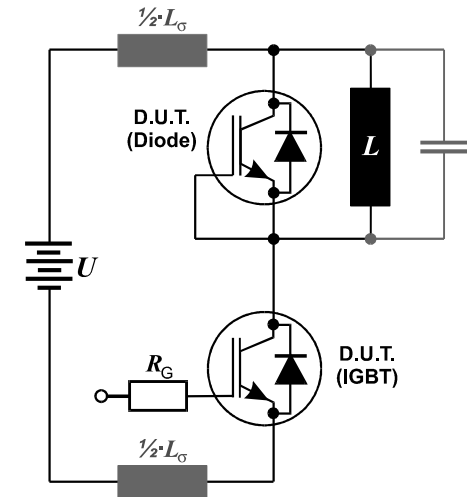


Figure E. Dynamic test circuit  
Leakage inductance  $L_\sigma=180\text{nH}$ ,  
and stray capacity  $C_\sigma=40\text{pF}$ .

**Edition 2006-01**

**Published by  
Infineon Technologies AG  
81726 München, Germany**

**© Infineon Technologies AG 9/12/07.**

**All Rights Reserved.**

**Attention please!**

The information given in this data sheet shall in no event be regarded as a guarantee of conditions or characteristics ("Beschaffenheitsgarantie"). With respect to any examples or hints given herein, any typical values stated herein and/or any information regarding the application of the device, Infineon Technologies hereby disclaims any and all warranties and liabilities of any kind, including without limitation warranties of non-infringement of intellectual property rights of any third party.

**Information**

For further information on technology, delivery terms and conditions and prices please contact your nearest Infineon Technologies Office ([www.infineon.com](http://www.infineon.com)).

**Warnings**

Due to technical requirements components may contain dangerous substances. For information on the types in question please contact your nearest Infineon Technologies Office.

Infineon Technologies Components may only be used in life-support devices or systems with the express written approval of Infineon Technologies, if a failure of such components can reasonably be expected to cause the failure of that life-support device or system, or to affect the safety or effectiveness of that device or system. Life support devices or systems are intended to be implanted in the human body, or to support and/or maintain and sustain and/or protect human life. If they fail, it is reasonable to assume that the health of the user or other persons may be endangered.