

Low Loss DuoPack : IGBT in **TrenchStop®** and Fieldstop technology
with soft, fast recovery anti-parallel EmCon HE diode

- Best in class TO247
- Short circuit withstand time – 10µs
- Designed for :
 - Frequency Converters
 - Uninterrupted Power Supply
- **TrenchStop®** and Fieldstop technology for 1200 V applications offers :
 - very tight parameter distribution
 - high ruggedness, temperature stable behavior
- NPT technology offers easy parallel switching capability due to positive temperature coefficient in $V_{CE(sat)}$
- Low EMI
- Low Gate Charge
- Very soft, fast recovery anti-parallel EmCon HE diode
- Qualified according to JEDEC¹ for target applications
- Pb-free lead plating; RoHS compliant
- Complete product spectrum and PSpice Models : <http://www.infineon.com/igbt/>

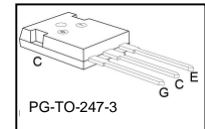
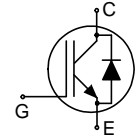

Type	V_{CE}	I_C	$V_{CE(sat), T_j=25^\circ C}$	$T_{j,max}$	Marking Code	Package
IKW40T120	1200V	40A	1.7V	150°C	K40T120	PG-TO-247-3

Maximum Ratings

Parameter	Symbol	Value	Unit
Collector-emitter voltage	V_{CE}	1200	V
DC collector current	I_C		A
$T_C = 25^\circ C$		75	
$T_C = 100^\circ C$		40	
Pulsed collector current, t_p limited by T_{jmax}	I_{Cpuls}	105	
Turn off safe operating area	-	105	
$V_{CE} \leq 1200V, T_j \leq 150^\circ C$			
Diode forward current	I_F		
$T_C = 25^\circ C$		80	
$T_C = 100^\circ C$		40	
Diode pulsed current, t_p limited by T_{jmax}	I_{Fpuls}	105	
Gate-emitter voltage	V_{GE}	± 20	V
Short circuit withstand time ²⁾	t_{SC}	10	µs
$V_{GE} = 15V, V_{CC} \leq 1200V, T_j \leq 150^\circ C$			
Power dissipation	P_{tot}	270	W
$T_C = 25^\circ C$			
Operating junction temperature	T_j	-40...+150	°C
Storage temperature	T_{stg}	-55...+150	

¹ J-STD-020 and JESD-022

²⁾ Allowed number of short circuits: <1000; time between short circuits: >1s.



TrenchStop[®] Series

IKW40T120

Soldering temperature, 1.6mm (0.063 in.) from case for 10s	-	260	
--	---	-----	--

Thermal Resistance

Parameter	Symbol	Conditions	Max. Value	Unit
Characteristic				
IGBT thermal resistance, junction – case	R_{thJC}		0.45	K/W
Diode thermal resistance, junction – case	R_{thJCD}		0.81	
Thermal resistance, junction – ambient	R_{thJA}		40	

Electrical Characteristic, at $T_j = 25^\circ\text{C}$, unless otherwise specified

Parameter	Symbol	Conditions	Value			Unit
			min.	typ.	max.	
Static Characteristic						
Collector-emitter breakdown voltage	$V_{(BR)CES}$	$V_{GE}=0V, I_C=1.5mA$	1200	-	-	V
Collector-emitter saturation voltage	$V_{CE(sat)}$	$V_{GE} = 15V, I_C=40A$ $T_j=25^\circ\text{C}$ $T_j=125^\circ\text{C}$ $T_j=150^\circ\text{C}$	- - -	1.7 2.1 2.3	2.3 - -	
Diode forward voltage	V_F	$V_{GE}=0V, I_F=40A$ $T_j=25^\circ\text{C}$ $T_j=125^\circ\text{C}$ $T_j=150^\circ\text{C}$	- - -	1.75 1.75 1.75	2.3 - -	
Gate-emitter threshold voltage	$V_{GE(th)}$	$I_C=1.5mA, V_{CE}=V_{GE}$	5.0	5.8	6.5	
Zero gate voltage collector current	I_{CES}	$V_{CE}=1200V,$ $V_{GE}=0V$ $T_j=25^\circ\text{C}$ $T_j=150^\circ\text{C}$	- -	- -	0.4 4.0	mA
Gate-emitter leakage current	I_{GES}	$V_{CE}=0V, V_{GE}=20V$	-	-	600	
Transconductance	g_{fs}	$V_{CE}=20V, I_C=40A$	-	21	-	S
Integrated gate resistor	R_{Gint}			6		Ω

Dynamic Characteristic

Input capacitance	C_{iss}	$V_{CE}=25V,$	-	2500	-	pF
Output capacitance	C_{oss}	$V_{GE}=0V,$	-	130	-	
Reverse transfer capacitance	C_{rss}	$f=1MHz$	-	110	-	
Gate charge	Q_{Gate}	$V_{CC}=960V, I_C=40A$ $V_{GE}=15V$	-	203	-	nC
Internal emitter inductance measured 5mm (0.197 in.) from case	L_E		-	13	-	nH
Short circuit collector current ¹⁾	$I_{C(SC)}$	$V_{GE}=15V, t_{SC} \leq 10\mu s$ $V_{CC} = 600V,$ $T_j = 25^\circ C$	-	210	-	A

Switching Characteristic, Inductive Load, at $T_j=25^\circ C$

Parameter	Symbol	Conditions	Value			Unit
			min.	typ.	max.	

IGBT Characteristic

Turn-on delay time	$t_{d(on)}$	$T_j=25^\circ C,$ $V_{CC}=600V, I_C=40A,$ $V_{GE}=0/15V,$ $R_G=15\Omega,$ $L_\sigma^{2)}=180nH,$ $C_\sigma^{2)}=39pF$ Energy losses include "tail" and diode reverse recovery.	-	48	-	ns
Rise time	t_r		-	34	-	
Turn-off delay time	$t_{d(off)}$		-	480	-	
Fall time	t_f		-	70	-	
Turn-on energy	E_{on}		-	3.3	-	mJ
Turn-off energy	E_{off}		-	3.2	-	
Total switching energy	E_{ts}		-	6.5	-	

Anti-Parallel Diode Characteristic

Diode reverse recovery time	t_{rr}	$T_j=25^\circ C,$	-	240	-	ns
Diode reverse recovery charge	Q_{rr}	$V_R=600V, I_F=40A,$	-	3.8	-	μC
Diode peak reverse recovery current	I_{rrm}	$di_F/dt=800A/\mu s$	-	28	-	A
Diode peak rate of fall of reverse recovery current during t_b	di_{rr}/dt		-	370	-	$A/\mu s$

¹⁾ Allowed number of short circuits: <1000; time between short circuits: >1s.

²⁾ Leakage inductance L_σ and Stray capacity C_σ due to dynamic test circuit in Figure E.

Switching Characteristic, Inductive Load, at $T_j=150^\circ\text{C}$

Parameter	Symbol	Conditions	Value			Unit	
			min.	typ.	max.		
IGBT Characteristic							
Turn-on delay time	$t_{d(on)}$	$T_j=150^\circ\text{C}$ $V_{CC}=600\text{V}, I_C=40\text{A},$ $V_{GE}=0/15\text{V},$ $R_G=15\Omega,$ $L_{\sigma}^{1)}=180\text{nH},$ $C_{\sigma}^{1)}=39\text{pF}$ Energy losses include "tail" and diode reverse recovery.	-	52	-	ns	
Rise time	t_r		-	40	-		
Turn-off delay time	$t_{d(off)}$		-	580	-		
Fall time	t_f		-	120	-		
Turn-on energy	E_{on}			-	5.0	-	mJ
Turn-off energy	E_{off}			-	5.4	-	
Total switching energy	E_{ts}			-	10.4	-	
Anti-Parallel Diode Characteristic							
Diode reverse recovery time	t_{rr}	$T_j=150^\circ\text{C}$ $V_R=600\text{V}, I_F=40\text{A},$ $di_F/dt=800\text{A}/\mu\text{s}$	-	410	-	ns	
Diode reverse recovery charge	Q_{rr}		-	8.8	-	μC	
Diode peak reverse recovery current	I_{rrm}		-	36	-	A	
Diode peak rate of fall of reverse recovery current during t_b	di_{rr}/dt		-	330		$\text{A}/\mu\text{s}$	

¹⁾ Leakage inductance L_{σ} and Stray capacity C_{σ} due to dynamic test circuit in Figure E.

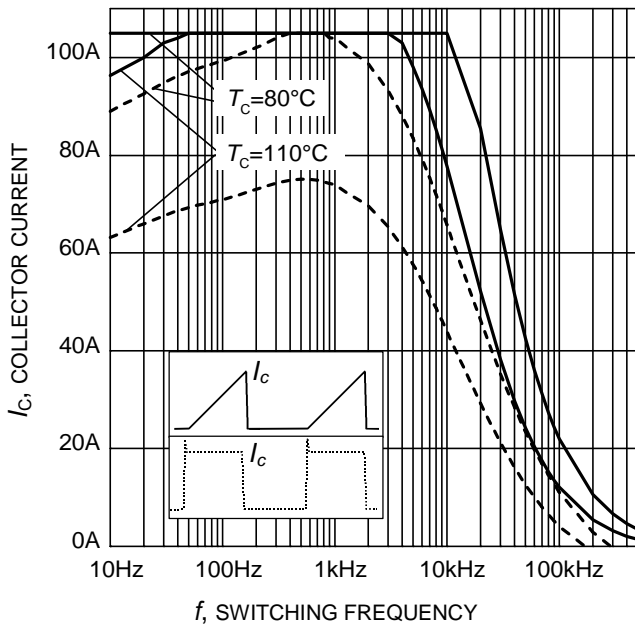

Figure 1. Collector current as a function of switching frequency
 ($T_j \leq 150^\circ\text{C}$, $D = 0.5$, $V_{CE} = 600\text{V}$,
 $V_{GE} = 0/+15\text{V}$, $R_G = 15\Omega$)

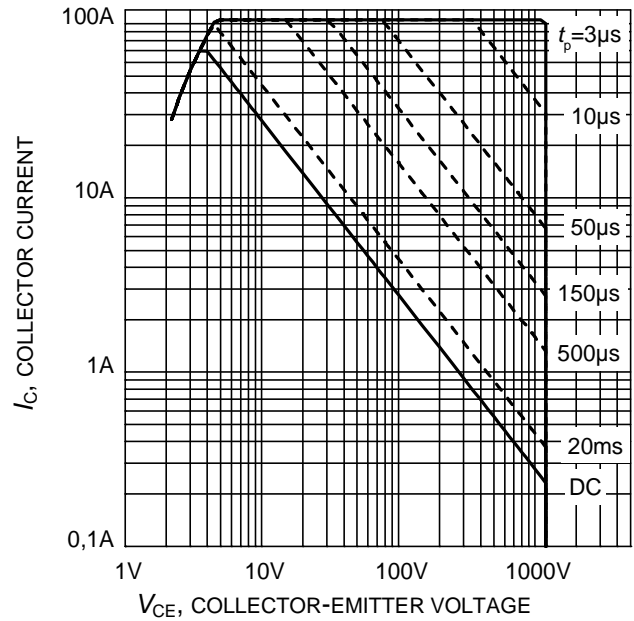

Figure 2. Safe operating area
 ($D = 0$, $T_C = 25^\circ\text{C}$,
 $T_j \leq 150^\circ\text{C}$; $V_{GE} = 15\text{V}$)

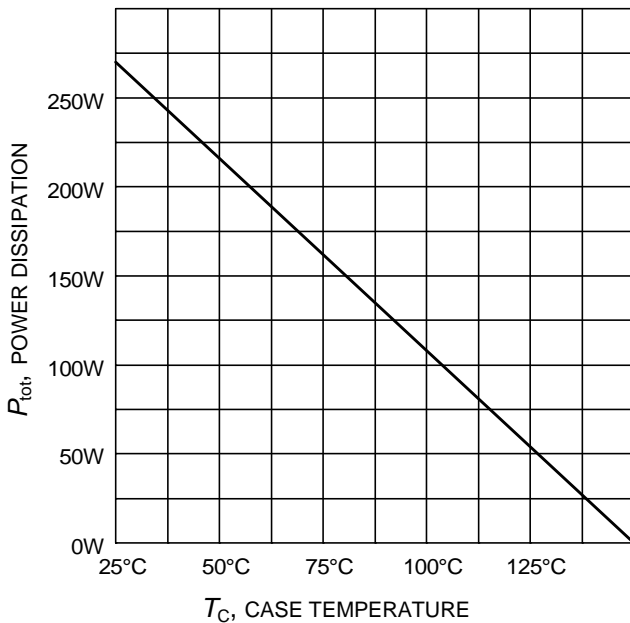

Figure 3. Power dissipation as a function of case temperature
 ($T_j \leq 150^\circ\text{C}$)

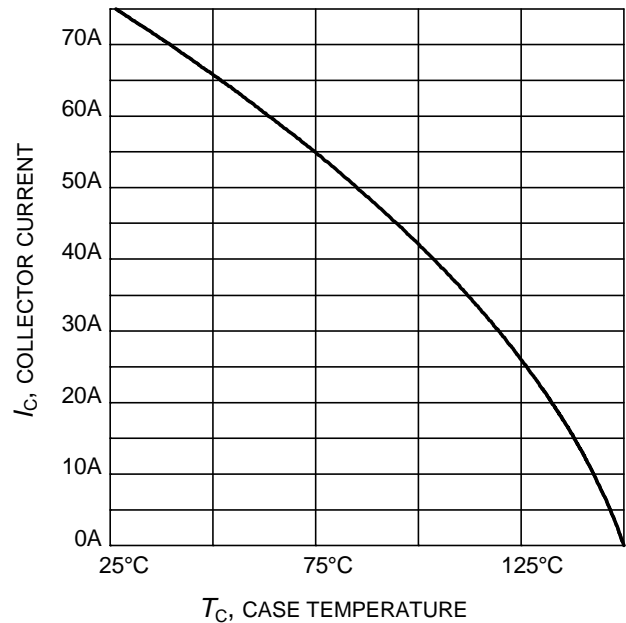

Figure 4. Collector current as a function of case temperature
 ($V_{GE} \geq 15\text{V}$, $T_j \leq 150^\circ\text{C}$)

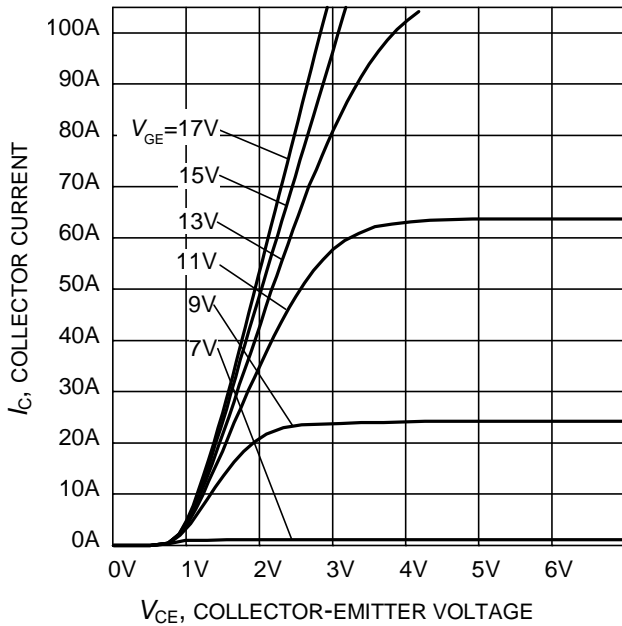

Figure 5. Typical output characteristic
($T_j = 25^\circ\text{C}$)

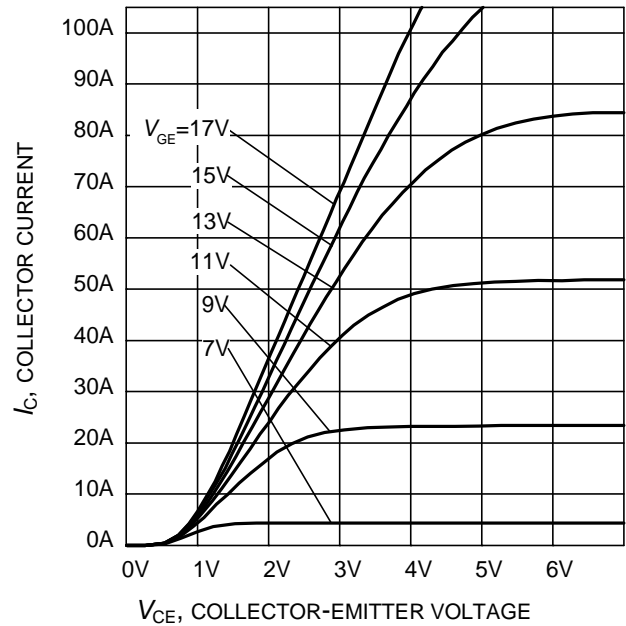

Figure 6. Typical output characteristic
($T_j = 150^\circ\text{C}$)

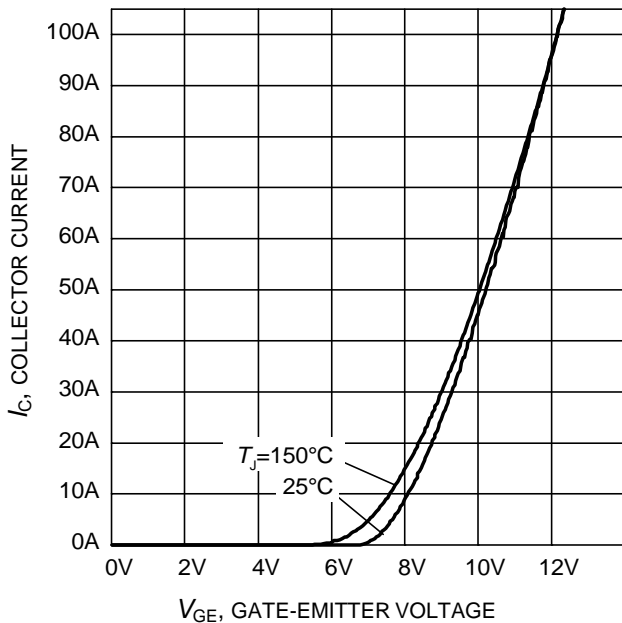

Figure 7. Typical transfer characteristic
($V_{CE} = 20\text{V}$)

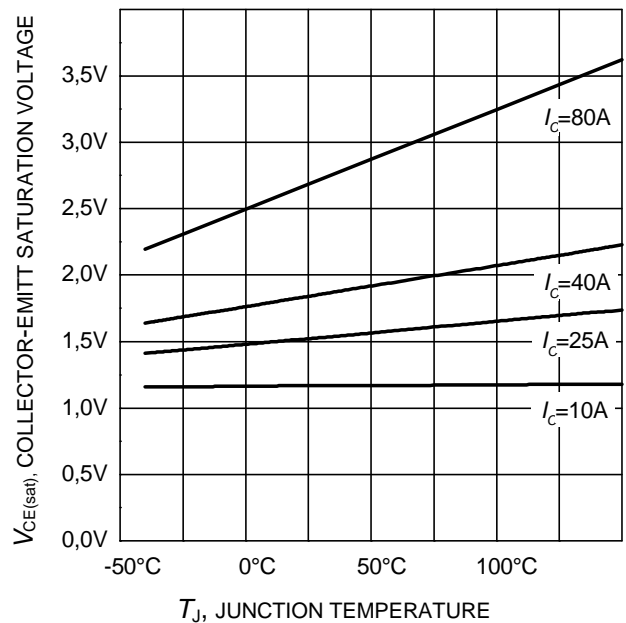

Figure 8. Typical collector-emitter saturation voltage as a function of junction temperature
($V_{GE} = 15\text{V}$)

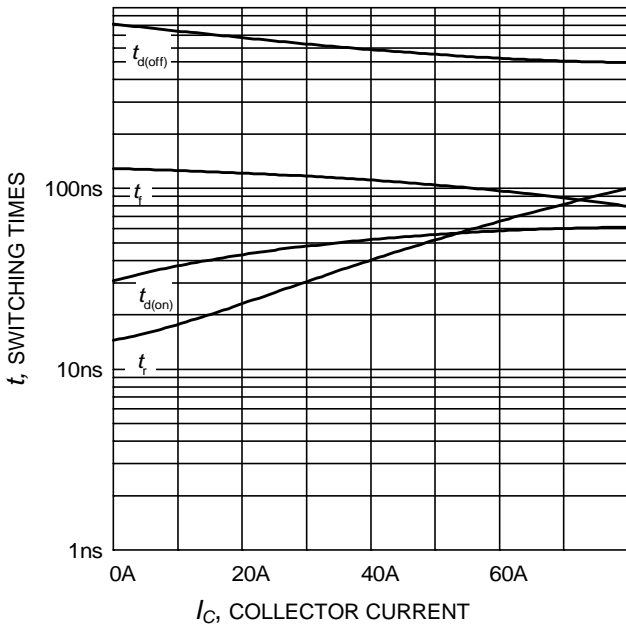

Figure 9. Typical switching times as a function of collector current
(inductive load, $T_J=150^{\circ}\text{C}$, $V_{CE}=600\text{V}$, $V_{GE}=0/15\text{V}$, $R_G=15\Omega$, Dynamic test circuit in Figure E)

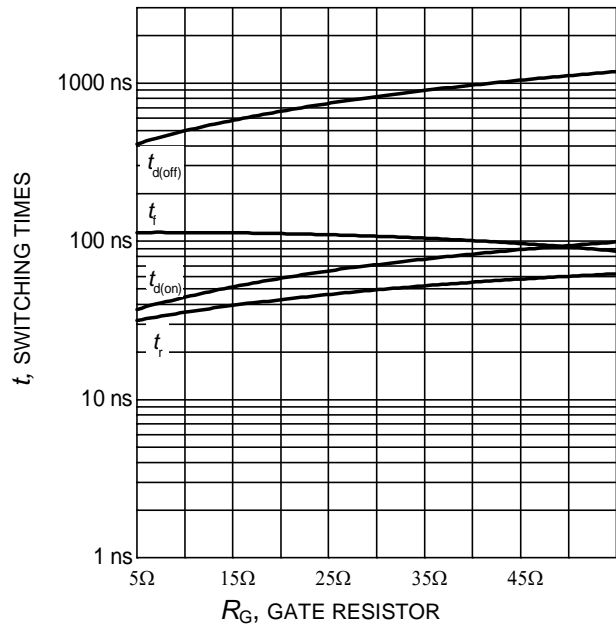

Figure 10. Typical switching times as a function of gate resistor
(inductive load, $T_J=150^{\circ}\text{C}$, $V_{CE}=600\text{V}$, $V_{GE}=0/15\text{V}$, $I_C=40\text{A}$, Dynamic test circuit in Figure E)

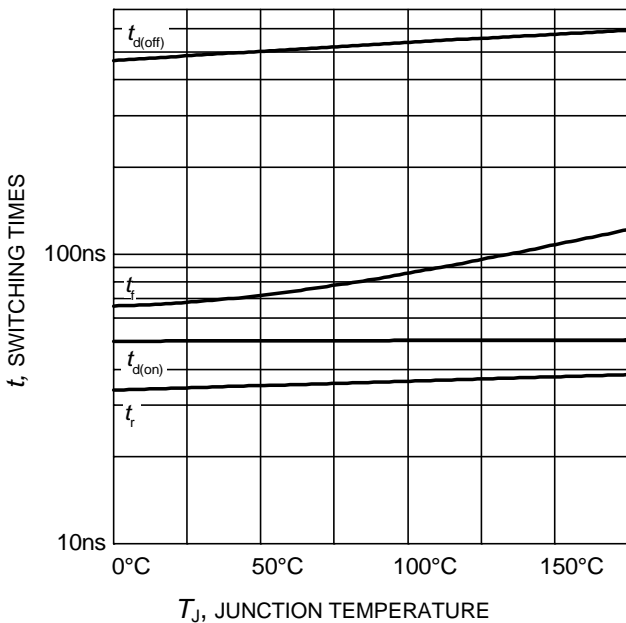

Figure 11. Typical switching times as a function of junction temperature
(inductive load, $V_{CE}=600\text{V}$, $V_{GE}=0/15\text{V}$, $I_C=40\text{A}$, $R_G=15\Omega$, Dynamic test circuit in Figure E)

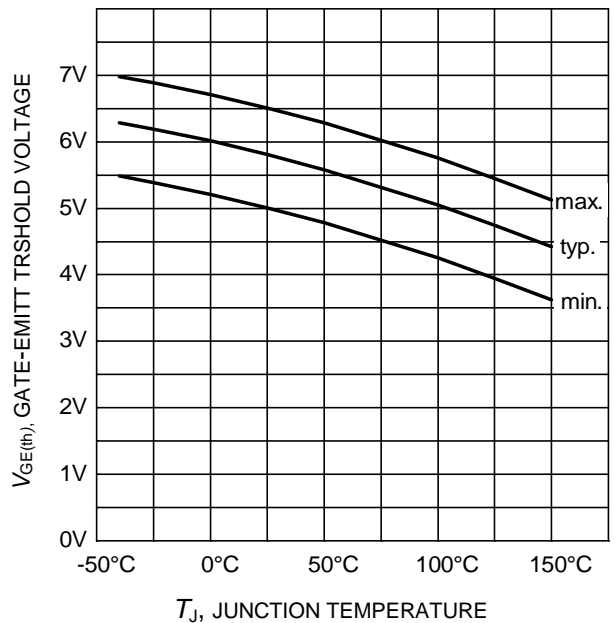

Figure 12. Gate-emitter threshold voltage as a function of junction temperature
($I_C = 1.5\text{mA}$)

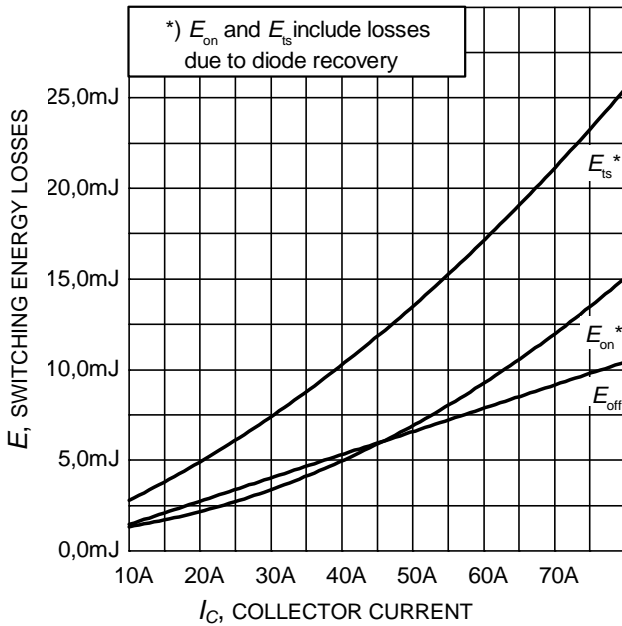

Figure 13. Typical switching energy losses as a function of collector current
 (inductive load, $T_J=150^{\circ}\text{C}$, $V_{CE}=600\text{V}$, $V_{GE}=0/15\text{V}$, $R_G=15\Omega$, Dynamic test circuit in Figure E)

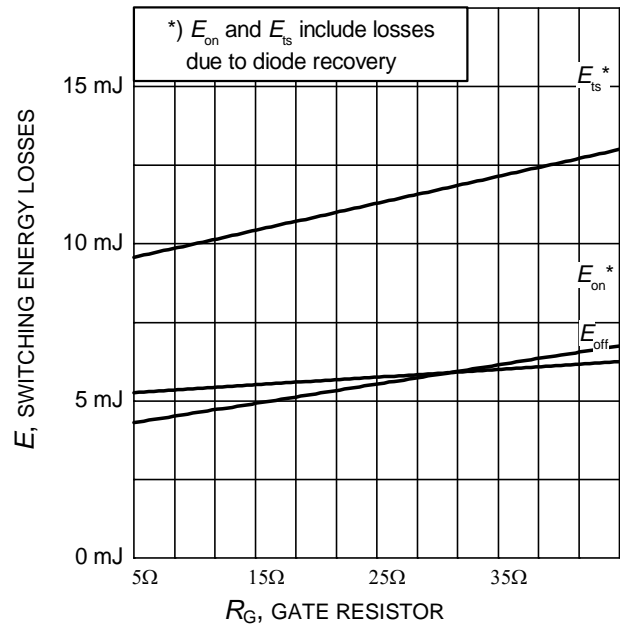

Figure 14. Typical switching energy losses as a function of gate resistor
 (inductive load, $T_J=150^{\circ}\text{C}$, $V_{CE}=600\text{V}$, $V_{GE}=0/15\text{V}$, $I_C=40\text{A}$, Dynamic test circuit in Figure E)

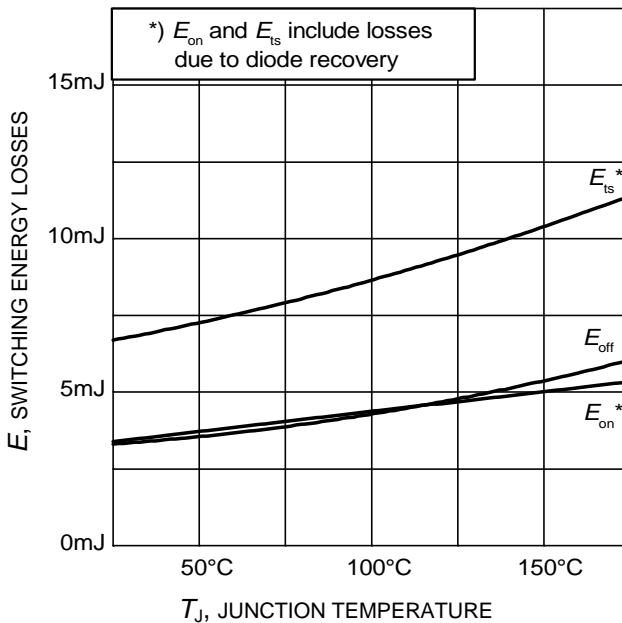

Figure 15. Typical switching energy losses as a function of junction temperature
 (inductive load, $V_{CE}=600\text{V}$, $V_{GE}=0/15\text{V}$, $I_C=40\text{A}$, $R_G=15\Omega$, Dynamic test circuit in Figure E)

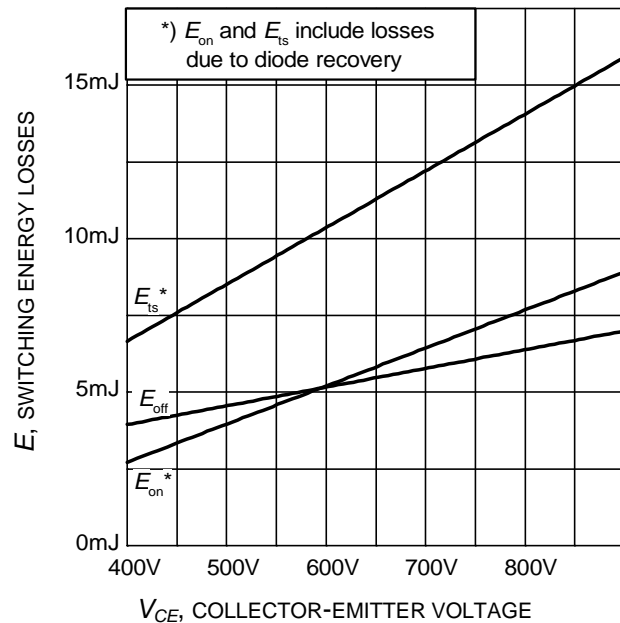

Figure 16. Typical switching energy losses as a function of collector emitter voltage
 (inductive load, $T_J=150^{\circ}\text{C}$, $V_{GE}=0/15\text{V}$, $I_C=40\text{A}$, $R_G=15\Omega$, Dynamic test circuit in Figure E)

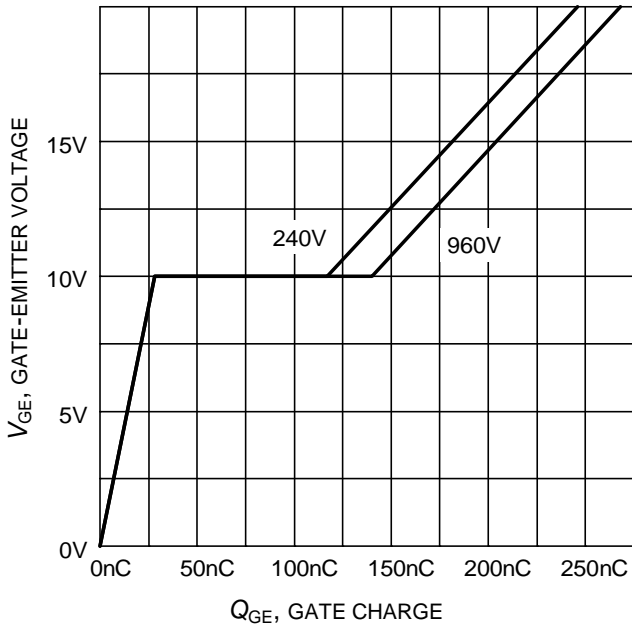

Figure 17. Typical gate charge
($I_C=40\text{ A}$)

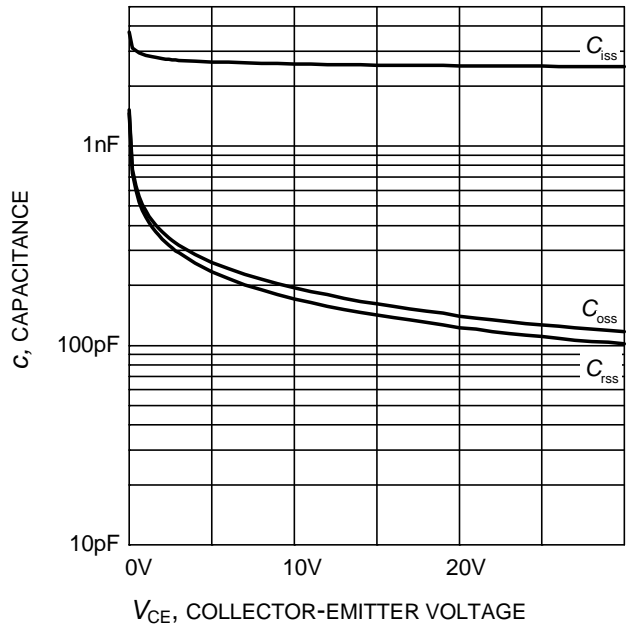

Figure 18. Typical capacitance as a function of collector-emitter voltage
($V_{GE}=0\text{V}$, $f = 1\text{ MHz}$)

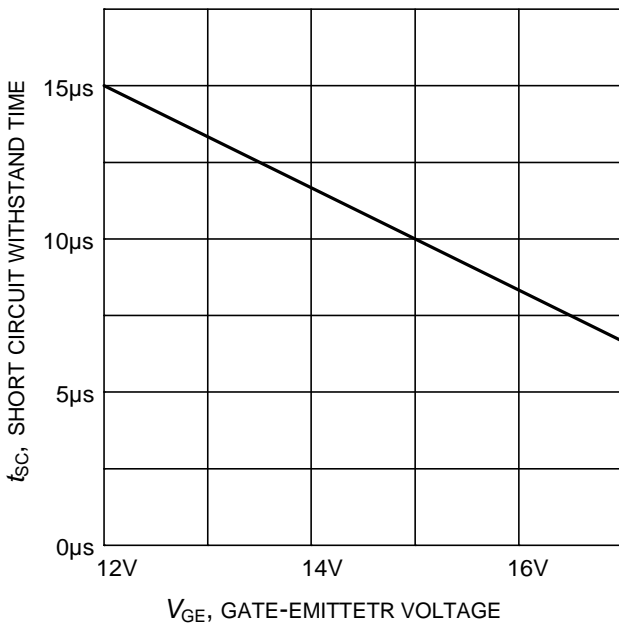

Figure 19. Short circuit withstand time as a function of gate-emitter voltage
($V_{CE}=600\text{V}$, start at $T_j=25^\circ\text{C}$)

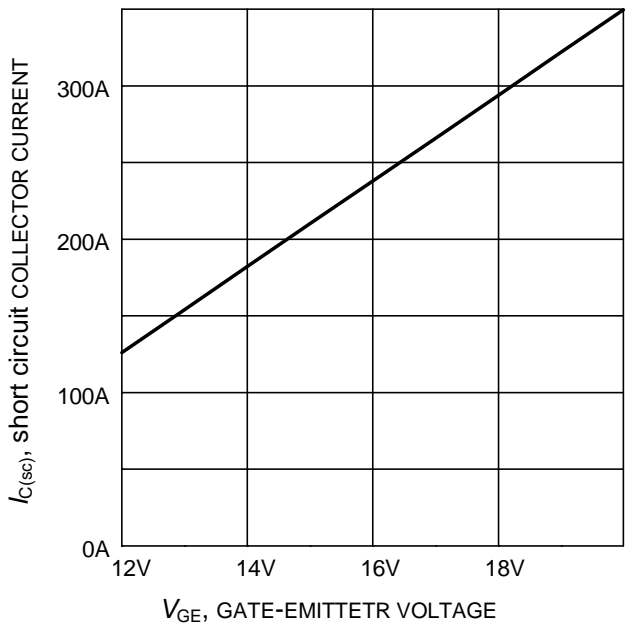

Figure 20. Typical short circuit collector current as a function of gate-emitter voltage
($V_{CE} \leq 600\text{V}$, $T_j \leq 150^\circ\text{C}$)

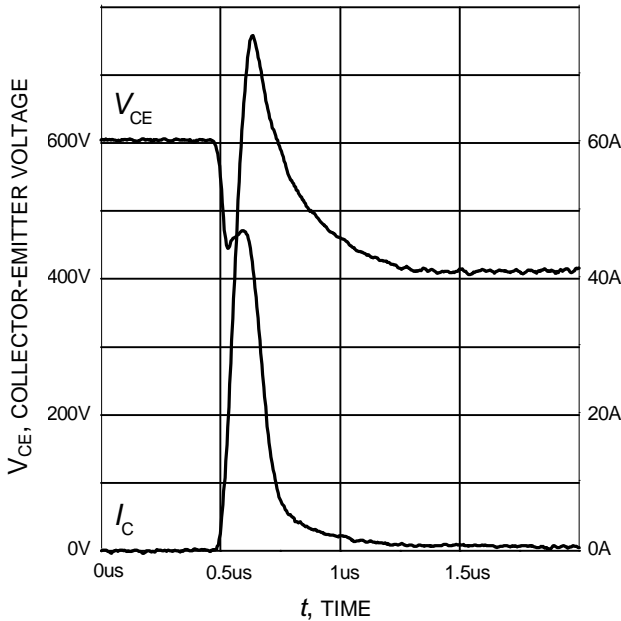

Figure 21. Typical turn on behavior
 ($V_{GE}=0/15V$, $R_G=15\Omega$, $T_j = 150^\circ C$,
 Dynamic test circuit in Figure E)

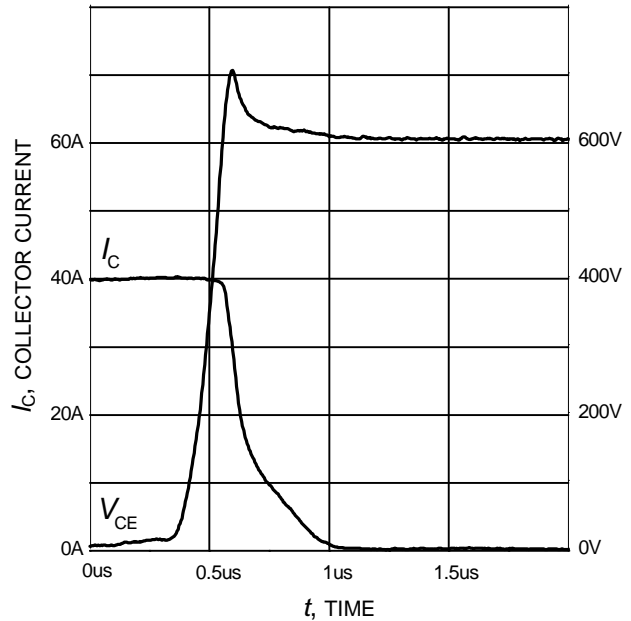

Figure 22. Typical turn off behavior
 ($V_{GE}=15/0V$, $R_G=15\Omega$, $T_j = 150^\circ C$,
 Dynamic test circuit in Figure E)

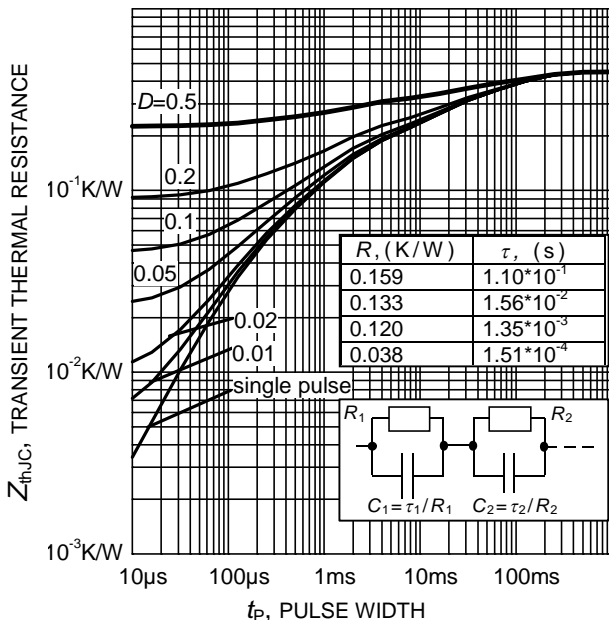

Figure 23. IGBT transient thermal resistance
 ($D = t_p / T$)

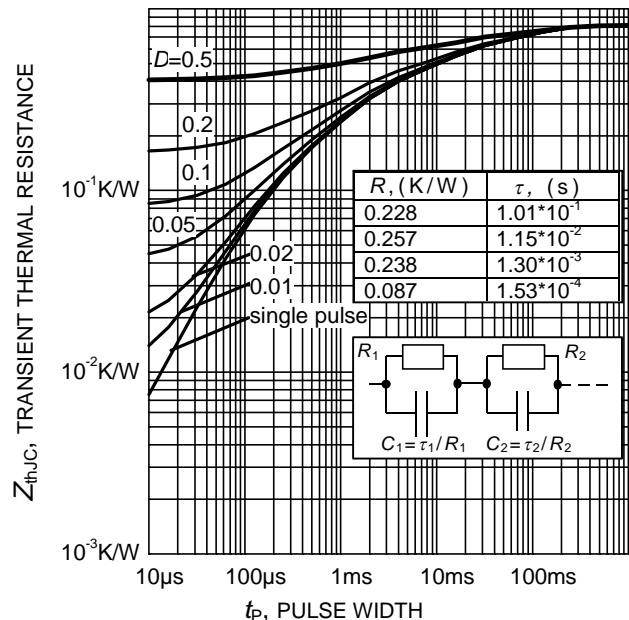

Figure 24. Diode transient thermal impedance as a function of pulse width
 ($D = t_p / T$)

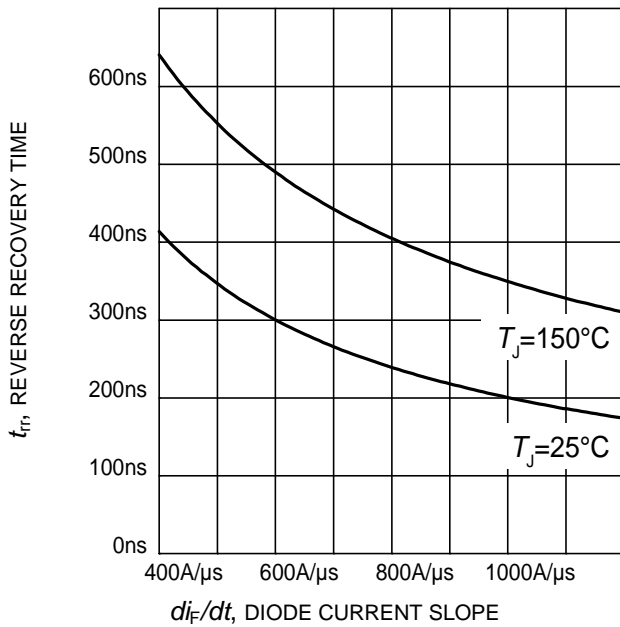

Figure 23. Typical reverse recovery time as a function of diode current slope
 ($V_R=600\text{V}$, $I_F=40\text{A}$,
 Dynamic test circuit in Figure E)

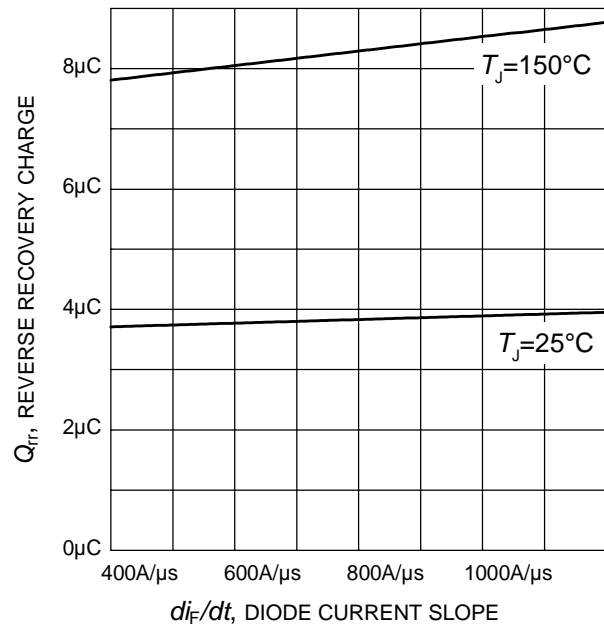

Figure 24. Typical reverse recovery charge as a function of diode current slope
 ($V_R=600\text{V}$, $I_F=40\text{A}$,
 Dynamic test circuit in Figure E)

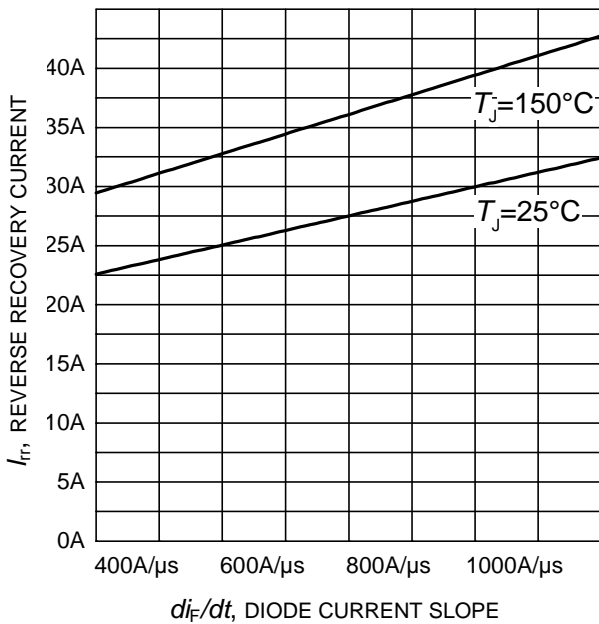

Figure 25. Typical reverse recovery current as a function of diode current slope
 ($V_R=600\text{V}$, $I_F=40\text{A}$,
 Dynamic test circuit in Figure E)

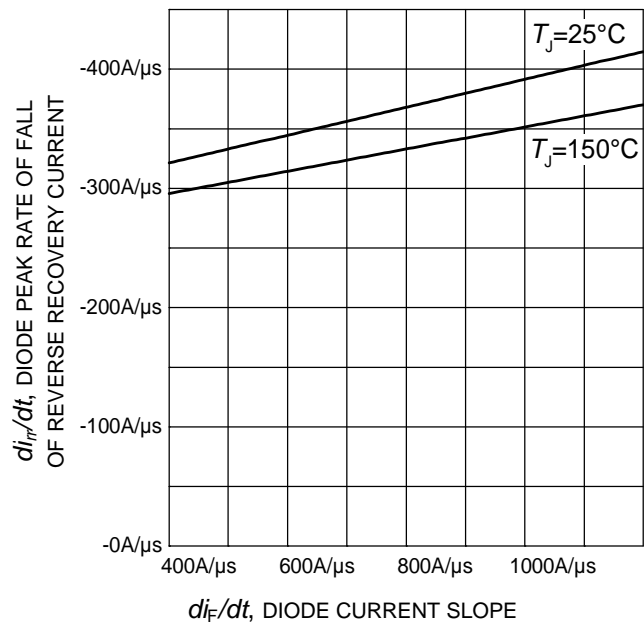

Figure 26. Typical diode peak rate of fall of reverse recovery current as a function of diode current slope
 ($V_R=600\text{V}$, $I_F=40\text{A}$,
 Dynamic test circuit in Figure E)

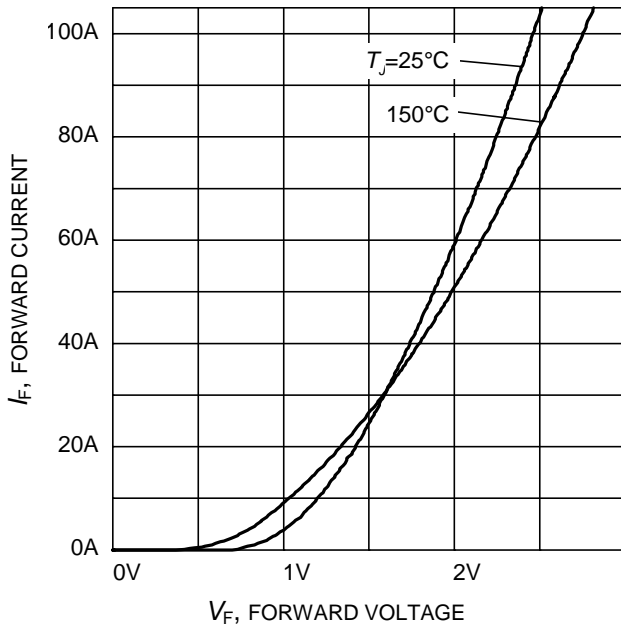

Figure 27. Typical diode forward current as a function of forward voltage

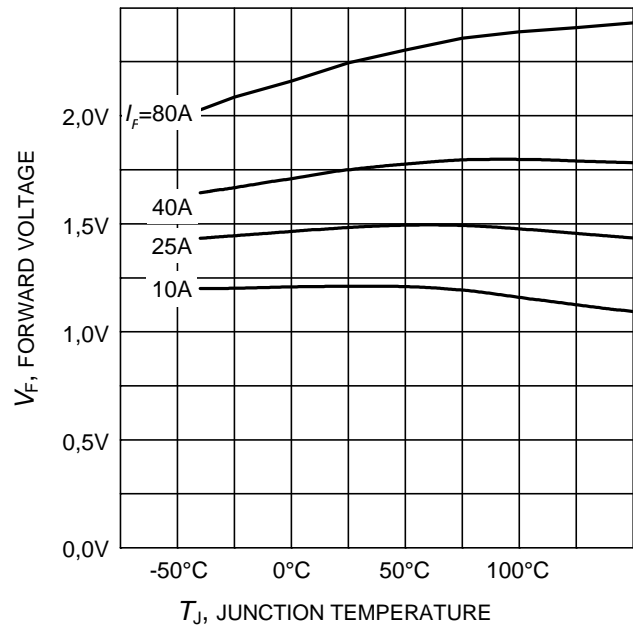
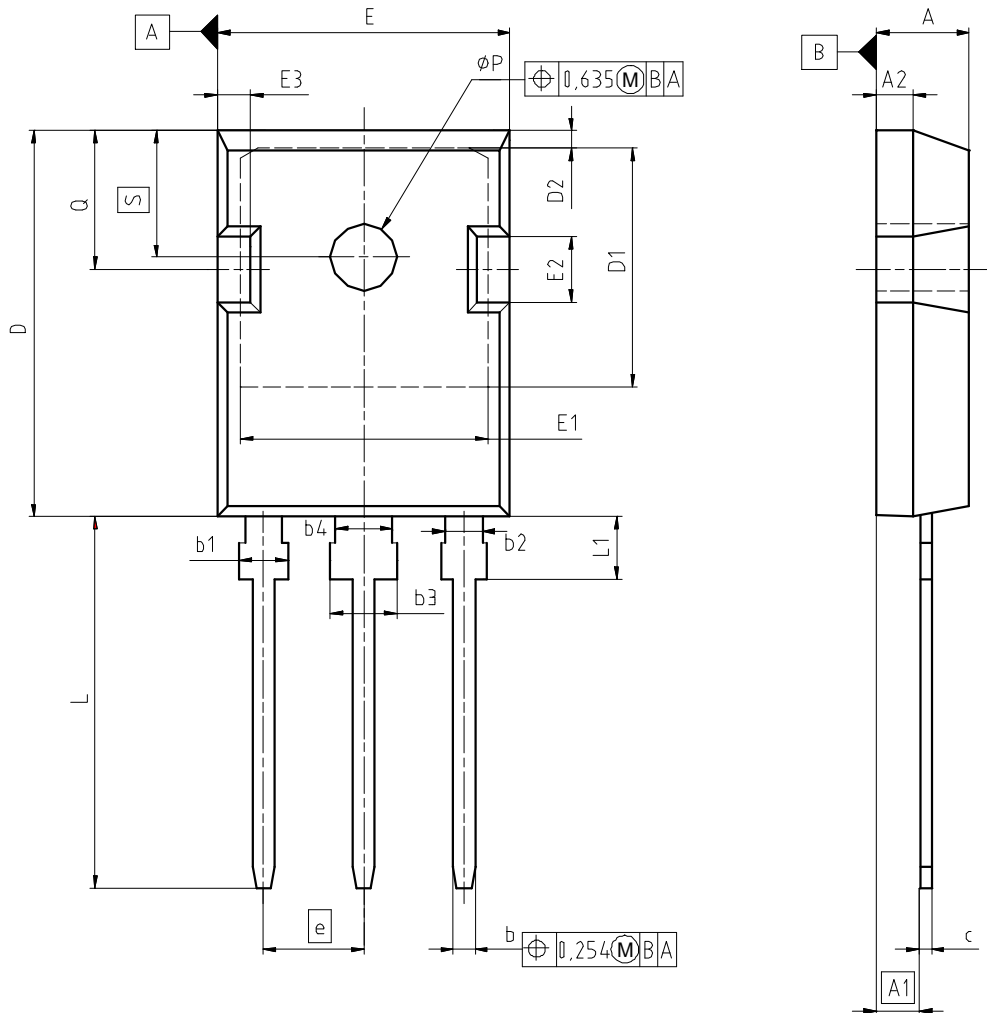

Figure 28. Typical diode forward voltage as a function of junction temperature

PG-TO247-3



DIM	MILLIMETERS		INCHES	
	MIN	MAX	MIN	MAX
A	4.90	5.16	0.193	0.203
A1	2.27	2.53	0.089	0.099
A2	1.85	2.11	0.073	0.083
b	1.07	1.33	0.042	0.052
b1	1.90	2.41	0.075	0.095
b2	1.90	2.16	0.075	0.085
b3	2.87	3.38	0.113	0.133
b4	2.87	3.13	0.113	0.123
c	0.55	0.68	0.022	0.027
D	20.82	21.10	0.820	0.831
D1	16.25	17.65	0.640	0.695
D2	1.05	1.35	0.041	0.053
E	15.70	16.03	0.618	0.631
E1	13.10	14.15	0.516	0.557
E2	3.68	5.10	0.145	0.201
E3	1.68	2.60	0.066	0.102
e	5.44		0.214	
N	3		3	
L	19.80	20.31	0.780	0.799
L1	4.17	4.47	0.164	0.176
ϕP	3.50	3.70	0.138	0.146
Q	5.49	6.00	0.216	0.236
S	6.04	6.30	0.238	0.248

DOCUMENT NO.
Z8B00003327

SCALE

EUROPEAN PROJECTION

ISSUE DATE
17-12-2007

REVISION
03

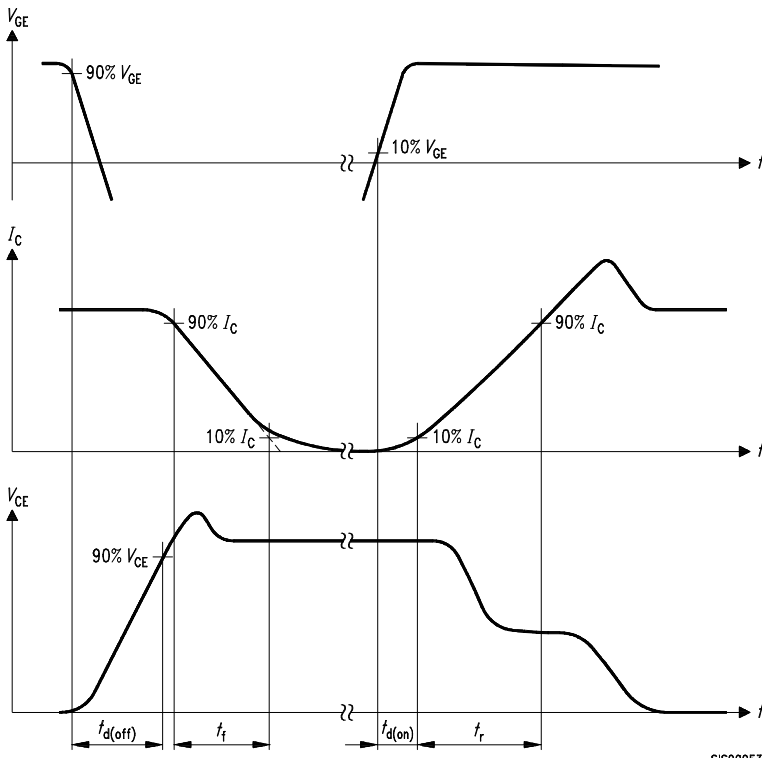

Figure A. Definition of switching times

SIS00053

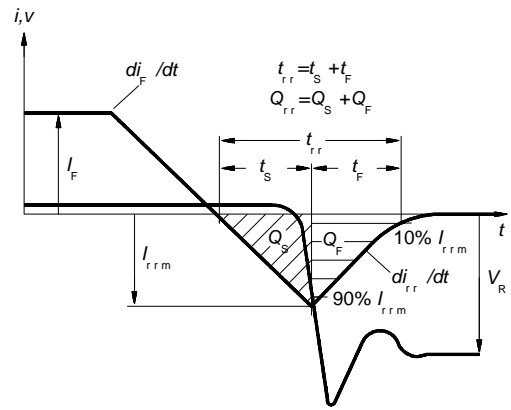

Figure C. Definition of diodes switching characteristics

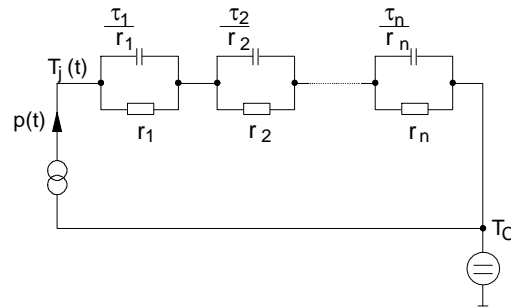

Figure D. Thermal equivalent circuit

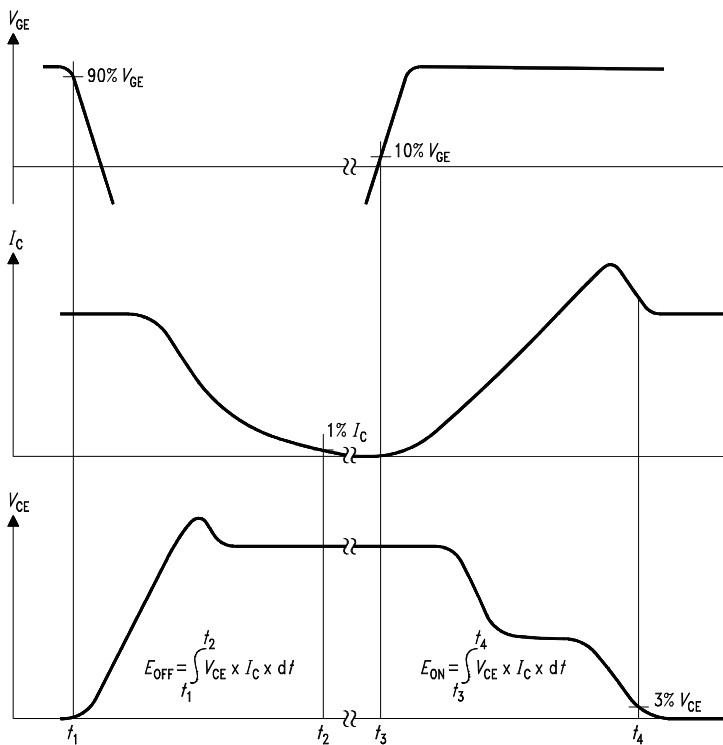

Figure B. Definition of switching losses

SIS

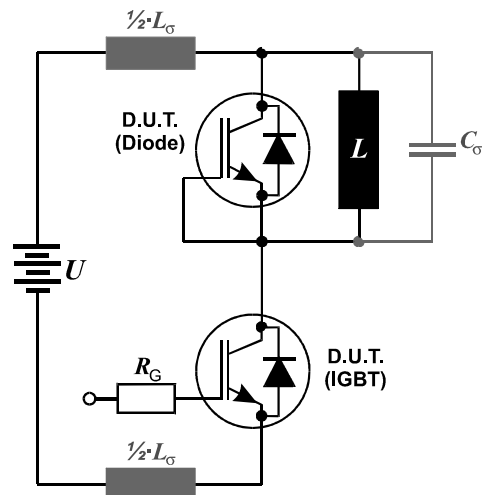

Figure E. Dynamic test circuit
Leakage inductance $L_{\sigma} = 180\text{nH}$
and Stray capacity $C_{\sigma} = 39\text{pF}$.

Published by
Infineon Technologies AG
81726 Munich, Germany
© 2008 Infineon Technologies AG
All Rights Reserved.

Legal Disclaimer

The information given in this document shall in no event be regarded as a guarantee of conditions or characteristics. With respect to any examples or hints given herein, any typical values stated herein and/or any information regarding the application of the device, Infineon Technologies hereby disclaims any and all warranties and liabilities of any kind, including without limitation, warranties of non-infringement of intellectual property rights of any third party.

Information

For further information on technology, delivery terms and conditions and prices, please contact the nearest Infineon Technologies Office (www.infineon.com).

Warnings

Due to technical requirements, components may contain dangerous substances. For information on the types in question, please contact the nearest Infineon Technologies Office. Infineon Technologies components may be used in life-support devices or systems only with the express written approval of Infineon Technologies, if a failure of such components can reasonably be expected to cause the failure of that life-support device or system or to affect the safety or effectiveness of that device or system. Life support devices or systems are intended to be implanted in the human body or to support and/or maintain and sustain and/or protect human life. If they fail, it is reasonable to assume that the health of the user or other persons may be endangered.