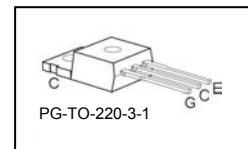
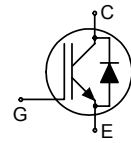


HighSpeed 2-Technology with soft, fast recovery anti-parallel EmCon HE diode

- **Designed for:**
  - SMPS
  - Lamp Ballast
  - ZVS-Converter
  - optimised for soft-switching / resonant topologies
- **2<sup>nd</sup> generation HighSpeed-Technology for 1200V applications offers:**
  - loss reduction in resonant circuits
  - temperature stable behavior
  - parallel switching capability
  - tight parameter distribution
  - $E_{off}$  optimized for  $I_C=1A$
- Pb-free lead plating; RoHS compliant
- Qualified according to JEDEC<sup>2</sup> for target applications
- Complete product spectrum and PSpice Models : <http://www.infineon.com/igbt/>



Type	$V_{CE}$	$I_C$	$E_{off}$	$T_j$	Marking	Package
IKP01N120H2	1200V	1A	0.09mJ	150°C	K01H1202	PG-TO-220-3-1

#### Maximum Ratings

Parameter	Symbol	Value	Unit
Collector-emitter voltage	$V_{CE}$	1200	V
Triangular collector current	$I_C$		A
$T_C = 25^\circ\text{C}$ , $f = 140\text{kHz}$		3.2	
$T_C = 100^\circ\text{C}$ , $f = 140\text{kHz}$		1.3	
Pulsed collector current, $t_p$ limited by $T_{jmax}$	$I_{Cpuls}$	3.5	
Turn off safe operating area $V_{CE} \leq 1200\text{V}$ , $T_j \leq 150^\circ\text{C}$	-	3.5	
Diode forward current	$I_F$		
$T_C = 25^\circ\text{C}$		3.2	
$T_C = 100^\circ\text{C}$		1.3	
Gate-emitter voltage	$V_{GE}$	$\pm 20$	V
Power dissipation	$P_{tot}$	28	W
$T_C = 25^\circ\text{C}$			
Operating junction and storage temperature	$T_j, T_{stg}$	-40...+150	°C
Soldering temperature, 1.6mm (0.063 in.) from case for 10s	-	260	

<sup>2</sup> J-STD-020 and JEDEC-022

**Thermal Resistance**

Parameter	Symbol	Conditions	Max. Value	Unit
<b>Characteristic</b>				
IGBT thermal resistance, junction – case	$R_{thJC}$		4.5	K/W
Diode thermal resistance, Junction - case	$R_{thJCD}$		11	
Thermal resistance, junction – ambient	$R_{thJA}$	PG-TO-220-3-1	62	

**Electrical Characteristic, at  $T_j = 25^\circ\text{C}$ , unless otherwise specified**

Parameter	Symbol	Conditions	Value			Unit
			min.	Typ.	max.	
<b>Static Characteristic</b>						
Collector-emitter breakdown voltage	$V_{(BR)CES}$	$V_{GE}=0V, I_C=300\mu A$	1200	-	-	V
Collector-emitter saturation voltage	$V_{CE(sat)}$	$V_{GE} = 15V, I_C=1A$ $T_j=25^\circ\text{C}$ $T_j=150^\circ\text{C}$	-	2.2	2.8	
			$V_{GE} = 10V, I_C=1A,$ $T_j=25^\circ\text{C}$	-	2.5	
				-	2.4	-
Gate-emitter threshold voltage	$V_{GE(th)}$	$I_C=30\mu A, V_{CE}=V_{GE}$	2.1	3	3.9	
Zero gate voltage collector current	$I_{CES}$	$V_{CE}=1200V, V_{GE}=0V$ $T_j=25^\circ\text{C}$ $T_j=150^\circ\text{C}$	-	-	20	$\mu A$
			-	-	80	
Diode forward voltage	$V_F$	$V_{GE} = 0, I_F=0.5A$ $T_j=25^\circ\text{C}$ $T_j=150^\circ\text{C}$	-	2.0	2.5	V
			-	1.75	-	
Gate-emitter leakage current	$I_{GES}$	$V_{CE}=0V, V_{GE}=20V$	-	-	40	nA
Transconductance	$g_{fs}$	$V_{CE}=20V, I_C=1A$	-	0.75	-	S
<b>Dynamic Characteristic</b>						
Input capacitance	$C_{iss}$	$V_{CE}=25V,$ $V_{GE}=0V,$ $f=1\text{MHz}$	-	91.6	-	pF
Output capacitance	$C_{oss}$		-	9.8	-	
Reverse transfer capacitance	$C_{riss}$		-	3.4	-	
Gate charge	$Q_{Gate}$	$V_{CC}=960V, I_C=1A$ $V_{GE}=15V$	-	8.6	-	nC
Internal emitter inductance measured 5mm (0.197 in.) from case	$L_E$		-	7	-	nH

**Switching Characteristic, Inductive Load, at  $T_j=25\text{ }^\circ\text{C}$** 

Parameter	Symbol	Conditions	Value			Unit
			min.	Typ.	max.	
<b>IGBT Characteristic</b>						
Turn-on delay time	$t_{d(on)}$	$T_j=25\text{ }^\circ\text{C}$ , $V_{CC}=800\text{V}$ , $I_C=1\text{A}$ , $V_{GE}=15\text{V}/0\text{V}$ , $R_G=241\Omega$ , $L_\sigma^{(2)}=180\text{nH}$ , $C_\sigma^{(2)}=40\text{pF}$ Energy losses include "tail" and diode <sup>3)</sup> reverse recovery.	-	13	-	ns
Rise time	$t_r$		-	6.3	-	
Turn-off delay time	$t_{d(off)}$		-	370	-	
Fall time	$t_f$		-	28	-	
Turn-on energy	$E_{on}$		-	0.08	-	mJ
Turn-off energy	$E_{off}$		-	0.06	-	
Total switching energy	$E_{ts}$		-	0.14	-	
<b>Anti-Parallel Diode Characteristic</b>						
Diode reverse recovery time	$t_{rr}$	$T_j=25\text{ }^\circ\text{C}$ , $V_R=800\text{V}$ , $I_F=1\text{A}$ , $R_G=241\Omega$	-	83	-	ns
Diode reverse recovery charge	$Q_{rr}$		-	89	-	$\mu\text{C}$
Diode peak reverse recovery current	$I_{rrm}$		-	2.5	-	A
Diode current slope	$di_F/dt$		-	289	-	$\text{A}/\mu\text{s}$
Diode peak rate of fall of reverse recovery current during $t_b$	$di_{rr}/dt$		-	178	-	

**Switching Characteristic, Inductive Load, at  $T_j=150\text{ }^\circ\text{C}$** 

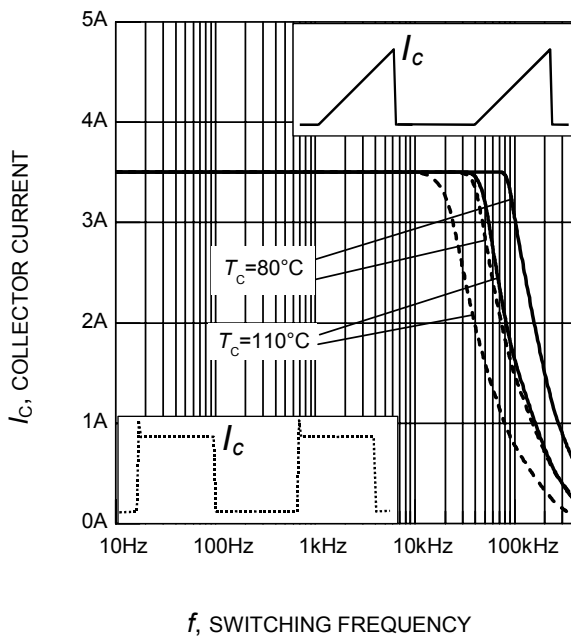
Parameter	Symbol	Conditions	Value			Unit
			min.	Typ.	max.	
<b>IGBT Characteristic</b>						
Turn-on delay time	$t_{d(on)}$	$T_j=150\text{ }^\circ\text{C}$ $V_{CC}=800\text{V}$ , $I_C=1\text{A}$ , $V_{GE}=15\text{V}/0\text{V}$ , $R_G=241\Omega$ , $L_\sigma^{(2)}=180\text{nH}$ , $C_\sigma^{(2)}=40\text{pF}$ Energy losses include "tail" and diode <sup>3)</sup> reverse recovery.	-	12	-	ns
Rise time	$t_r$		-	8.9	-	
Turn-off delay time	$t_{d(off)}$		-	450	-	
Fall time	$t_f$		-	43	-	
Turn-on energy	$E_{on}$		-	0.11	-	mJ
Turn-off energy	$E_{off}$		-	0.09	-	
Total switching energy	$E_{ts}$		-	0.2	-	
<b>Anti-Parallel Diode Characteristic</b>						
Diode reverse recovery time	$t_{rr}$	$T_j=150\text{ }^\circ\text{C}$ $V_R=800\text{V}$ , $I_F=1\text{A}$ , $R_G=241\Omega$	-	213	-	ns
Diode reverse recovery charge	$Q_{rr}$		-	180	-	$\mu\text{C}$
Diode peak reverse recovery current	$I_{rrm}$		-	2.7	-	A
Diode current slope	$di_F/dt$		-	240	-	$\text{A}/\mu\text{s}$
Diode peak rate of fall of reverse recovery current during $t_b$	$di_{rr}/dt$		-	135	-	

<sup>2)</sup> Leakage inductance  $L_\sigma$  and stray capacity  $C_\sigma$  due to dynamic test circuit in figure E

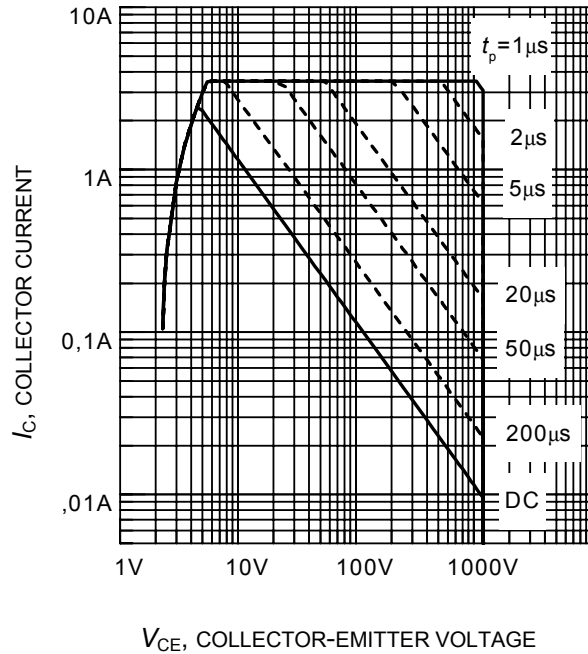
<sup>3)</sup> Commutation diode from device IKP01N120H2

**Switching Energy ZVT, Inductive Load**

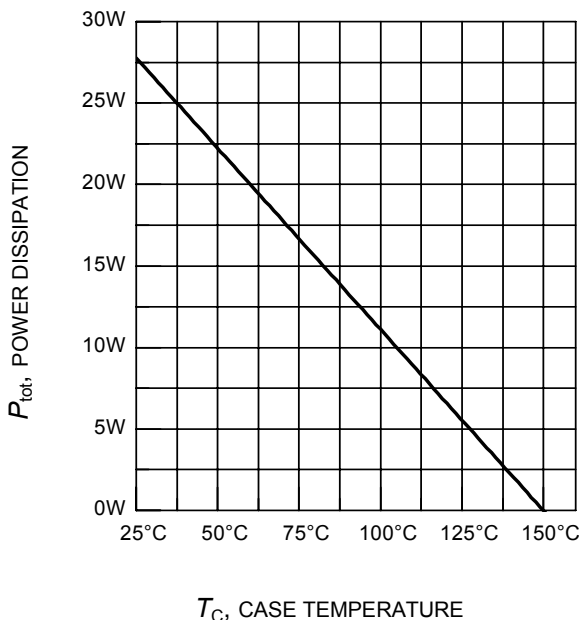
Parameter	Symbol	Conditions	Value			Unit
			min.	typ.	max.	
<b>IGBT Characteristic</b>						
Turn-off energy	$E_{off}$	$V_{CC}=800V,$ $I_C=1A,$ $V_{GE}=15V/0V,$ $R_G=241\Omega,$ $C_r^{2)}=1nF$ $T_j=25^\circ C$ $T_j=150^\circ C$	-	0.02	-	mJ
			-	0.044	-	



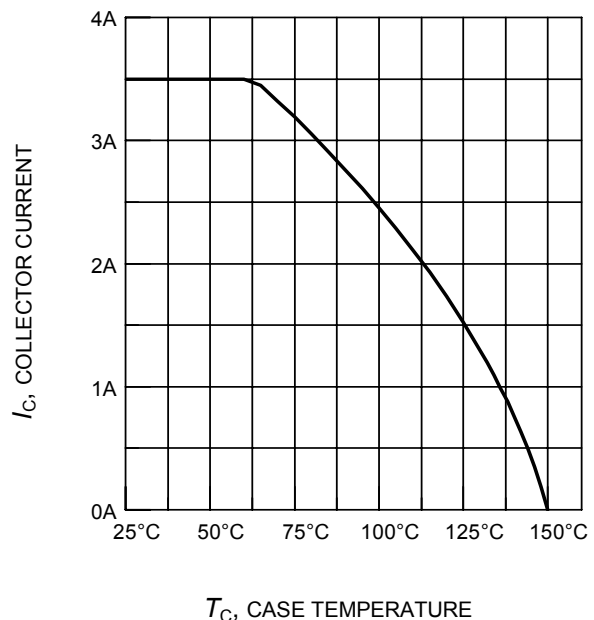
**Figure 1. Collector current as a function of switching frequency**  
 ( $T_j \leq 150^\circ\text{C}$ ,  $D = 0.5$ ,  $V_{CE} = 800\text{V}$ ,  $V_{GE} = +15\text{V}/0\text{V}$ ,  $R_G = 241\Omega$ )



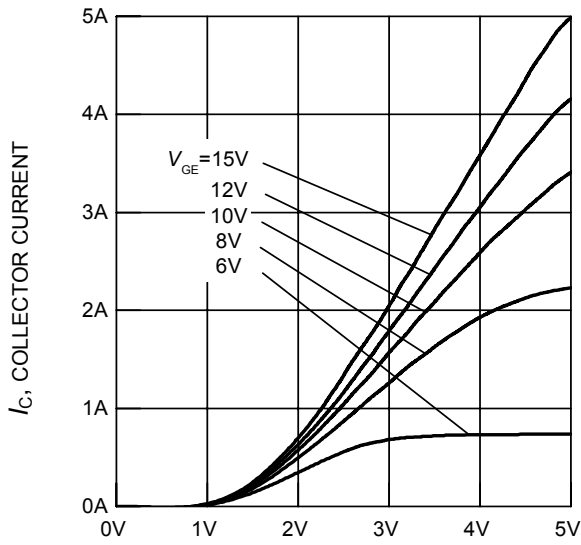
**Figure 2. Safe operating area**  
 ( $D = 0$ ,  $T_C = 25^\circ\text{C}$ ,  $T_j \leq 150^\circ\text{C}$ )



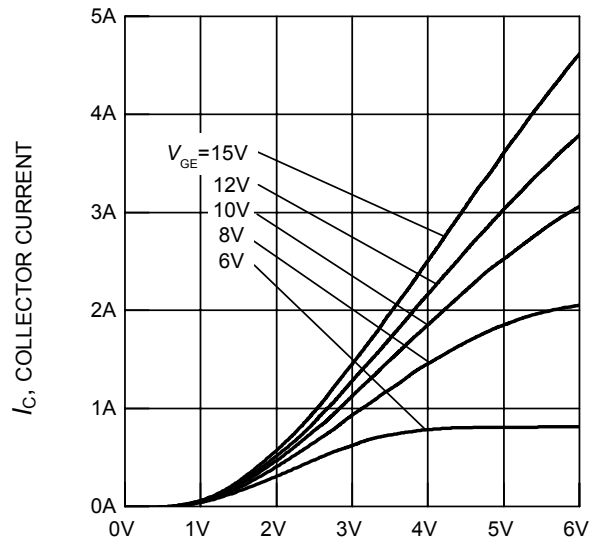
**Figure 3. Power dissipation as a function of case temperature**  
 ( $T_j \leq 150^\circ\text{C}$ )



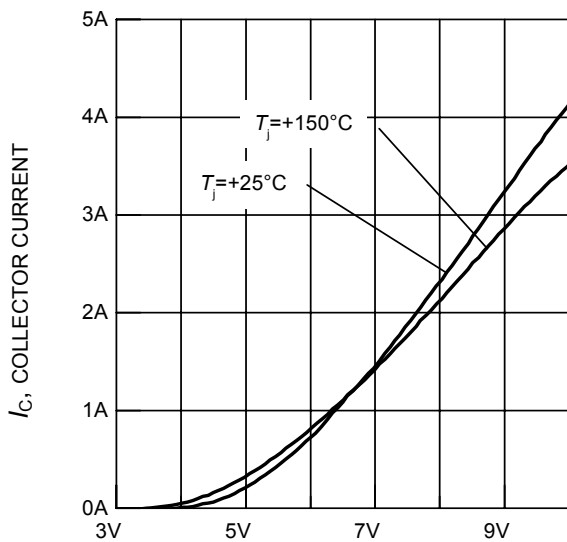
**Figure 4. Collector current as a function of case temperature**  
 ( $V_{GE} \leq 15\text{V}$ ,  $T_j \leq 150^\circ\text{C}$ )



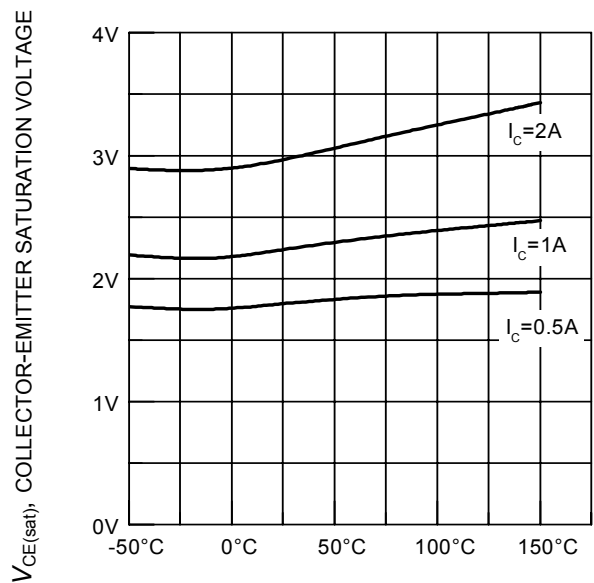
$V_{CE}$ , COLLECTOR-EMITTER VOLTAGE  
**Figure 5. Typical output characteristics**  
 ( $T_j = 25^\circ\text{C}$ )



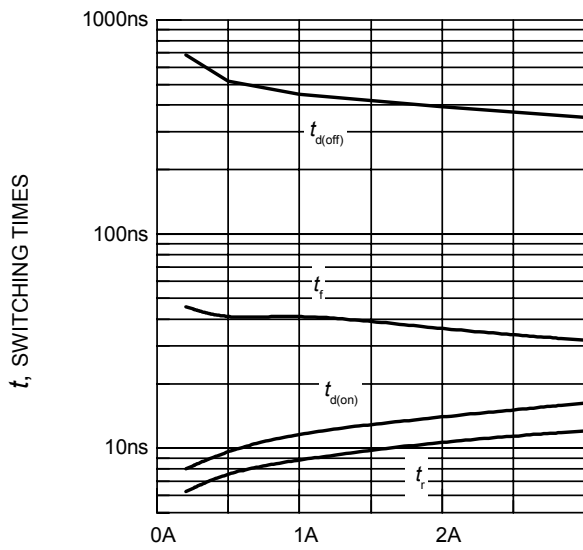
$V_{CE}$ , COLLECTOR-EMITTER VOLTAGE  
**Figure 6. Typical output characteristics**  
 ( $T_j = 150^\circ\text{C}$ )



$V_{GE}$ , GATE-EMITTER VOLTAGE  
**Figure 7. Typical transfer characteristics**  
 ( $V_{CE} = 20\text{V}$ )



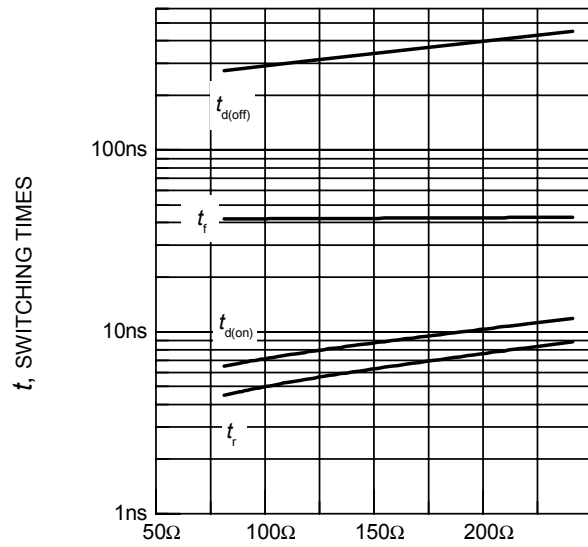
$T_j$ , JUNCTION TEMPERATURE  
**Figure 8. Typical collector-emitter saturation voltage as a function of junction temperature**  
 ( $V_{GE} = 15\text{V}$ )



$I_C$ , COLLECTOR CURRENT

**Figure 9. Typical switching times as a function of collector current**

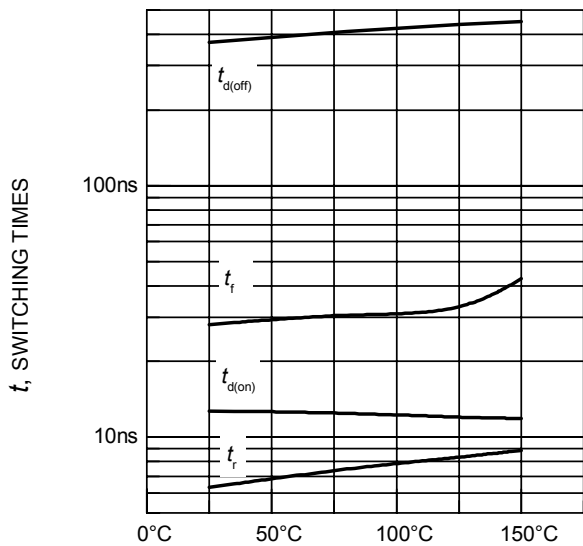
(inductive load,  $T_j = 150^\circ\text{C}$ ,  $V_{CE} = 800\text{V}$ ,  $V_{GE} = +15\text{V}/0\text{V}$ ,  $R_G = 241\Omega$ , dynamic test circuit in Fig.E)



$R_G$ , GATE RESISTOR

**Figure 10. Typical switching times as a function of gate resistor**

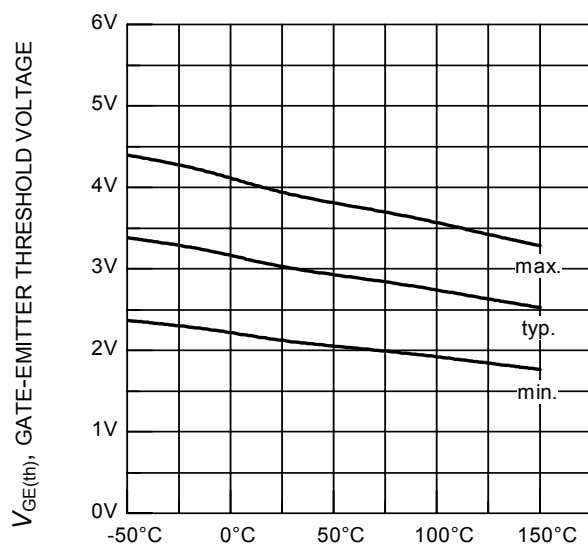
(inductive load,  $T_j = 150^\circ\text{C}$ ,  $V_{CE} = 800\text{V}$ ,  $V_{GE} = +15\text{V}/0\text{V}$ ,  $I_C = 1\text{A}$ , dynamic test circuit in Fig.E)



$T_j$ , JUNCTION TEMPERATURE

**Figure 11. Typical switching times as a function of junction temperature**

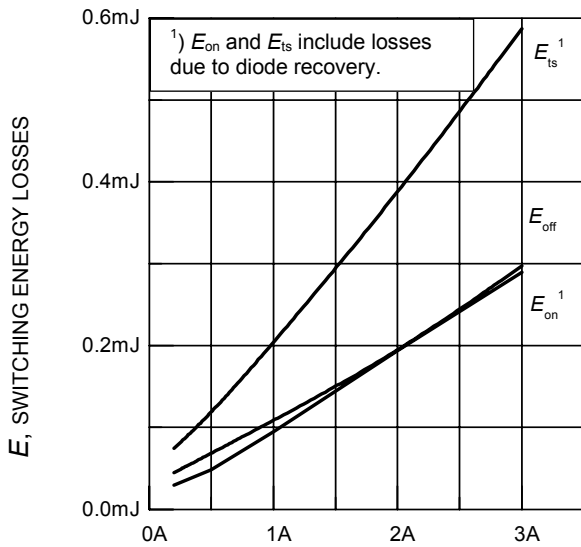
(inductive load,  $V_{CE} = 800\text{V}$ ,  $V_{GE} = +15\text{V}/0\text{V}$ ,  $I_C = 1\text{A}$ ,  $R_G = 241\Omega$ , dynamic test circuit in Fig.E)



$T_j$ , JUNCTION TEMPERATURE

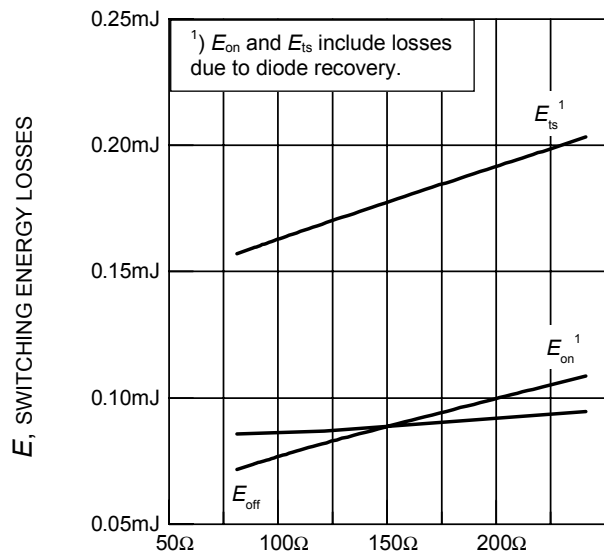
**Figure 12. Gate-emitter threshold voltage as a function of junction temperature**

( $I_C = 0.03\text{mA}$ )



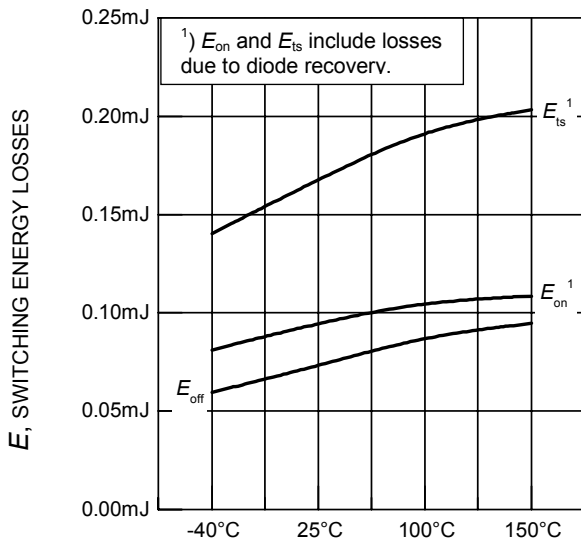
$I_C$ , COLLECTOR CURRENT

**Figure 13. Typical switching energy losses as a function of collector current**  
(inductive load,  $T_j = 150^\circ\text{C}$ ,  $V_{CE} = 800\text{V}$ ,  $V_{GE} = +15\text{V}/0\text{V}$ ,  $R_G = 241\Omega$ , dynamic test circuit in Fig.E )



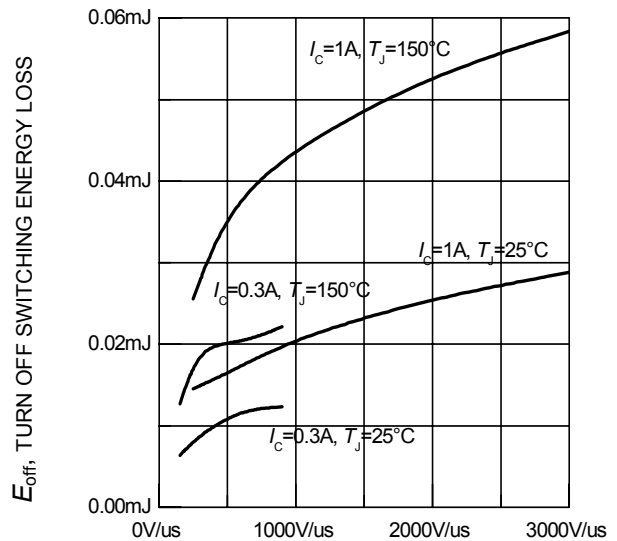
$R_G$ , GATE RESISTOR

**Figure 14. Typical switching energy losses as a function of gate resistor**  
(inductive load,  $T_j = 150^\circ\text{C}$ ,  $V_{CE} = 800\text{V}$ ,  $V_{GE} = +15\text{V}/0\text{V}$ ,  $I_C = 1\text{A}$ , dynamic test circuit in Fig.E )



$T_j$ , JUNCTION TEMPERATURE

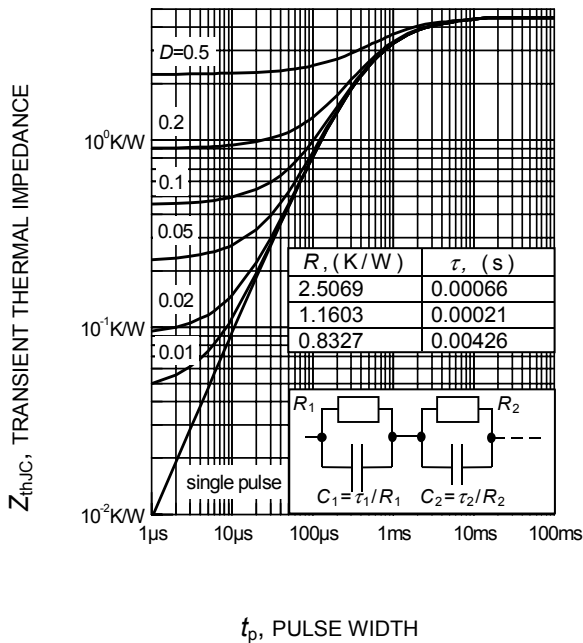
**Figure 15. Typical switching energy losses as a function of junction temperature**  
(inductive load,  $V_{CE} = 800\text{V}$ ,  $V_{GE} = +15\text{V}/0\text{V}$ ,  $I_C = 1\text{A}$ ,  $R_G = 241\Omega$ , dynamic test circuit in Fig.E )



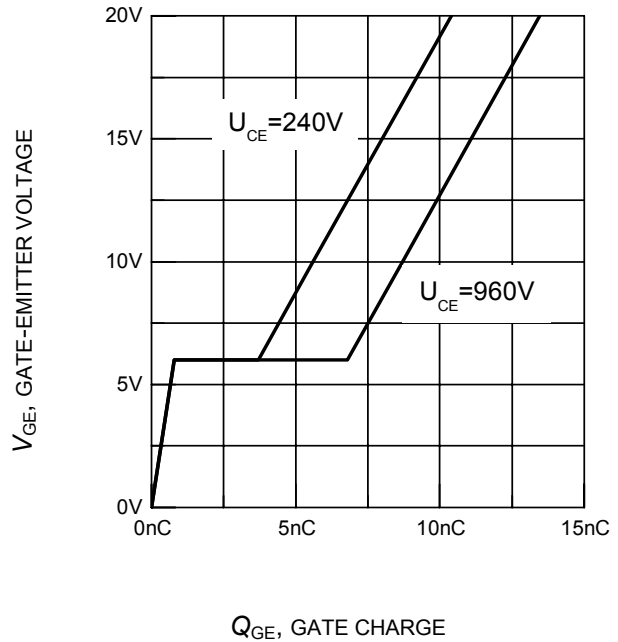
$dv/dt$ , VOLTAGE SLOPE

**Figure 16. Typical turn off switching energy loss for soft switching**  
(dynamic test circuit in Fig. E)

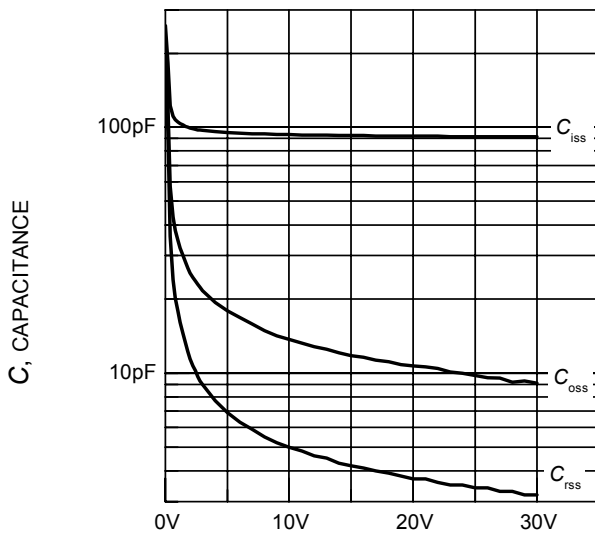




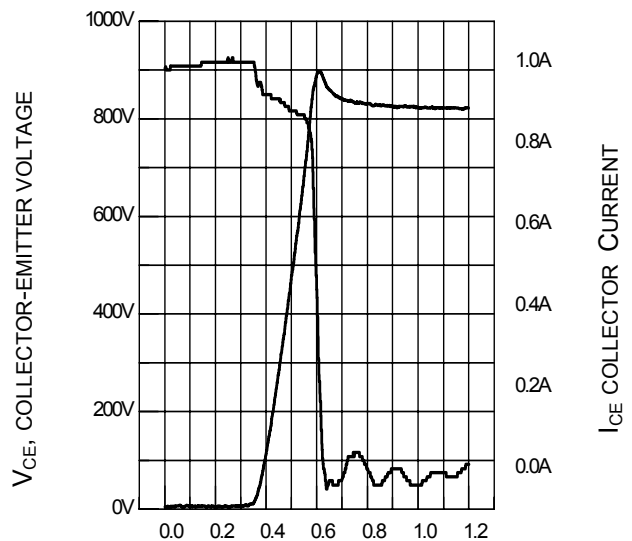
**Figure 17. IGBT transient thermal impedance as a function of pulse width**  
 $(D = t_p / T)$



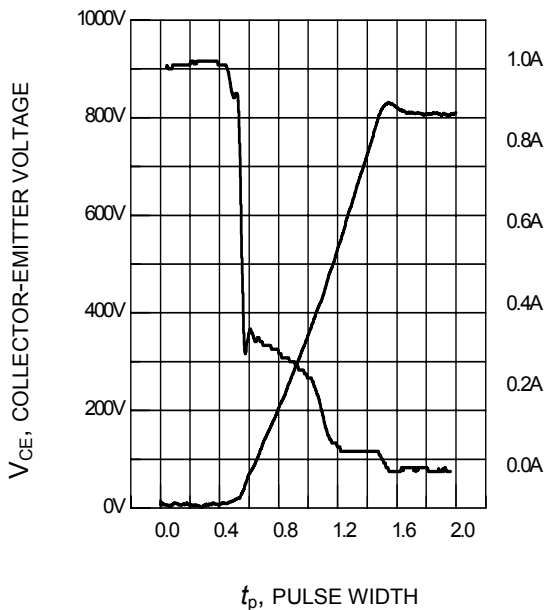
**Figure 18. Typical gate charge**  
 $(I_C = 1A)$



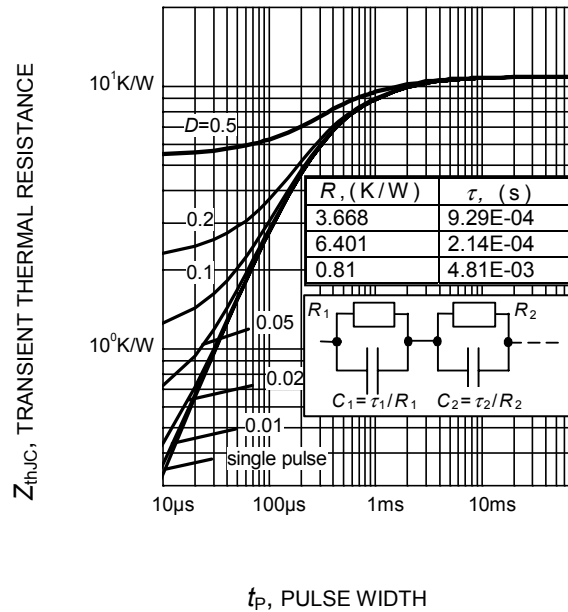
**Figure 19. Typical capacitance as a function of collector-emitter voltage**  
 $(V_{GE} = 0V, f = 1MHz)$



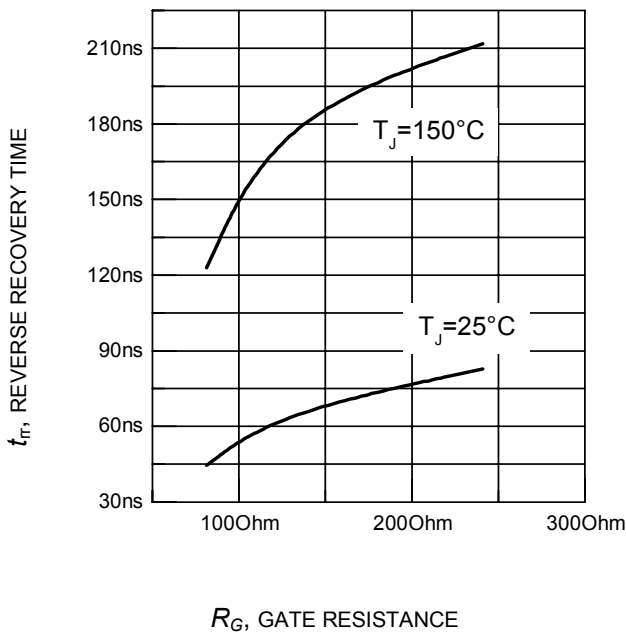
**Figure 20. Typical turn off behavior, hard switching**  
 $(V_{GE}=15/0V, R_G=220\Omega, T_j = 150^\circ C,$   
 Dynamic test circuit in Figure E)



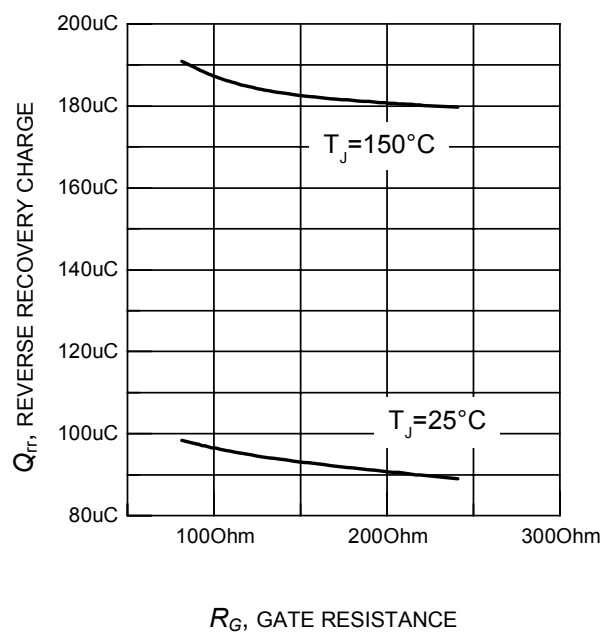
**Figure 21. Typical turn off behavior, soft switching**  
 ( $V_{GE}=15/0V$ ,  $R_G=220\Omega$ ,  $T_j = 150^\circ C$ ,  
 Dynamic test circuit in Figure E)



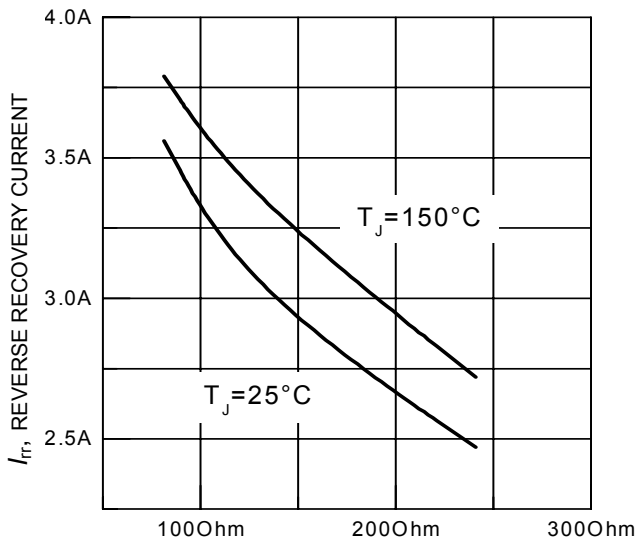
**Figure 22. Diode transient thermal impedance as a function of pulse width**  
 ( $D=t_p/T$ )



**Figure 23. Typical reverse recovery time as a function of diode current slope**  
 ( $V_R=800V$ ,  $I_F=3A$ ,  
 Dynamic test circuit in Figure E)

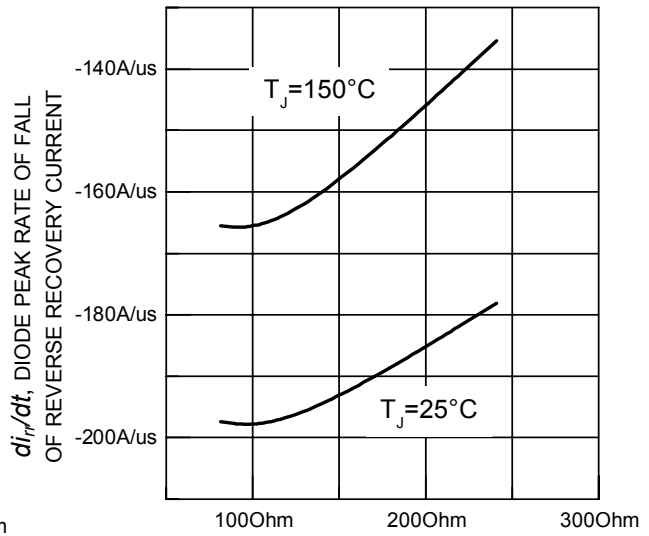


**Figure 24. Typical reverse recovery charge as a function of diode current slope**  
 ( $V_R=800V$ ,  $I_F=3A$ ,  
 Dynamic test circuit in Figure E)



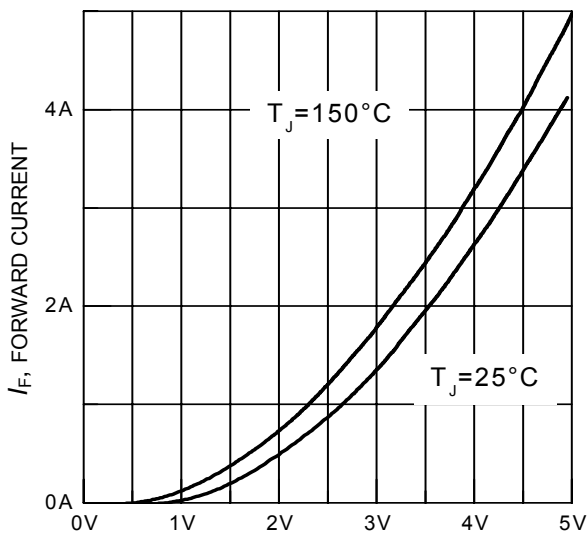
$R_G$ , GATE RESISTANCE

**Figure 25. Typical reverse recovery current as a function of diode current slope**  
 ( $V_R=800\text{V}$ ,  $I_F=3\text{A}$ ,  
 Dynamic test circuit in Figure E)



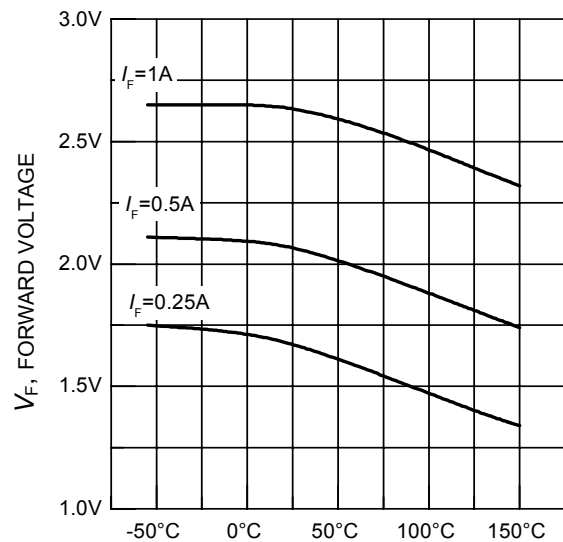
$R_G$ , GATE RESISTANCE

**Figure 26. Typical diode peak rate of fall of reverse recovery current as a function of diode current slope**  
 ( $V_R=800\text{V}$ ,  $I_F=3\text{A}$ ,  
 Dynamic test circuit in Figure E)



$V_F$ , FORWARD VOLTAGE

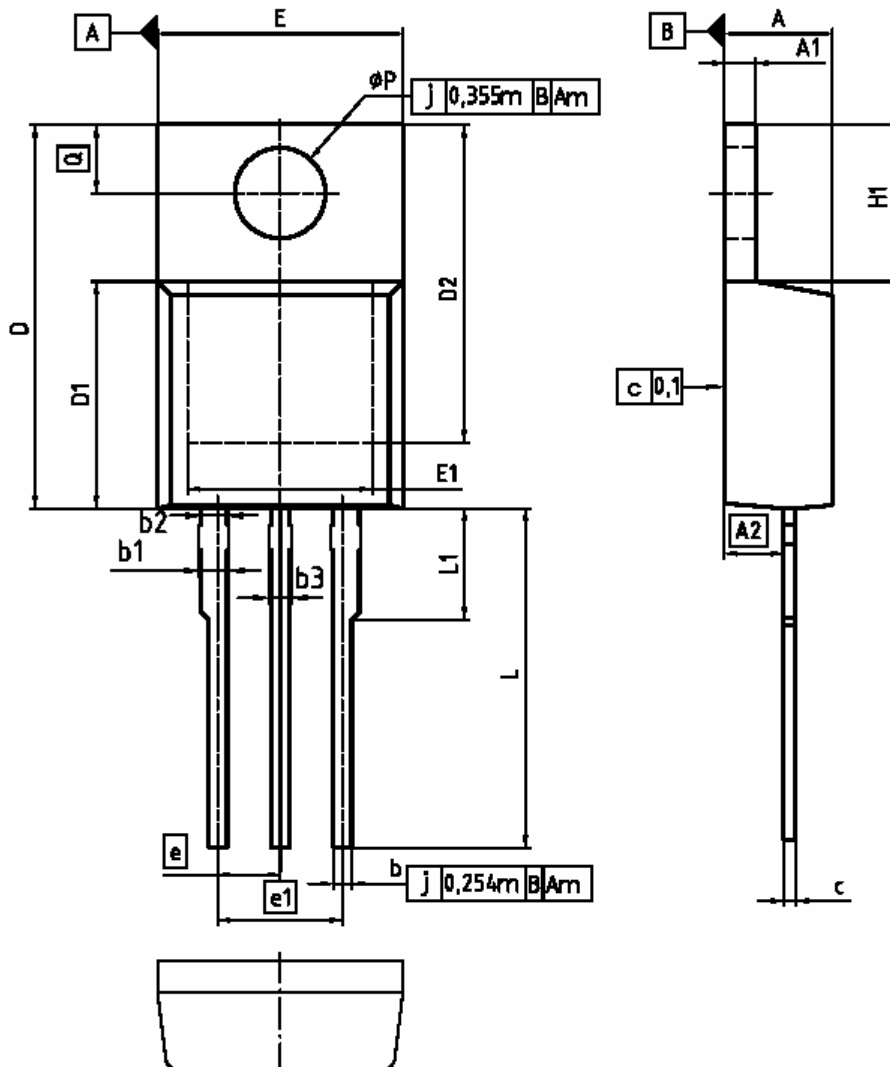
**Figure 27. Typical diode forward current as a function of forward voltage**



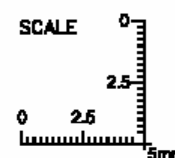

$T_J$ , JUNCTION TEMPERATURE

**Figure 28. Typical diode forward voltage as a function of junction temperature**

PG-TO220-3-1



DIM	MILLIMETERS		INCHES	
	MIN	MAX	MIN	MAX
A	4.30	4.67	0.169	0.180
A1	1.17	1.40	0.046	0.055
A2	2.15	2.72	0.085	0.107
b	0.85	0.86	0.028	0.034
b1	0.95	1.40	0.037	0.055
b2	0.85	1.15	0.037	0.045
b3	0.85	1.15	0.028	0.045
c	0.33	0.80	0.013	0.024
D	14.81	15.95	0.583	0.628
D1	8.61	9.46	0.336	0.372
D2	12.19	13.10	0.480	0.516
E	9.70	10.36	0.382	0.408
E1	6.60	8.00	0.258	0.319
e	2.54		0.100	
e1	5.08		0.200	
N	3		3	
H1	5.90	6.90	0.232	0.272
L	13.00	14.00	0.512	0.551
L1	-	4.80	-	0.189
mP	3.80	3.89	0.142	0.153
Q	2.80	3.00	0.102	0.118

DOCUMENT NO. Z8B00003318
SCALE 
EUROPEAN PROJECTION 
ISSUE DATE 23-08-2007
REVISION 05

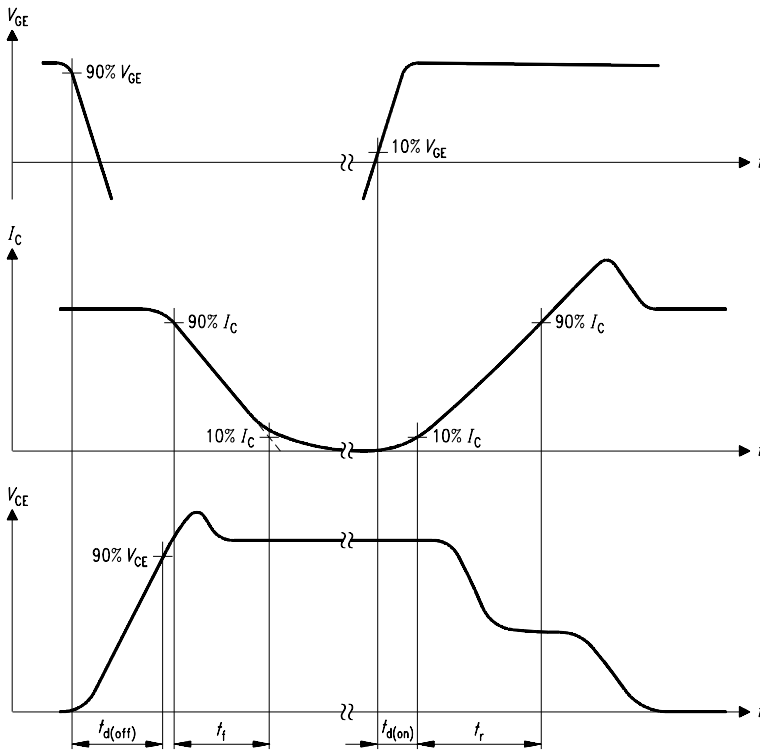


Figure A. Definition of switching times

SIS00053

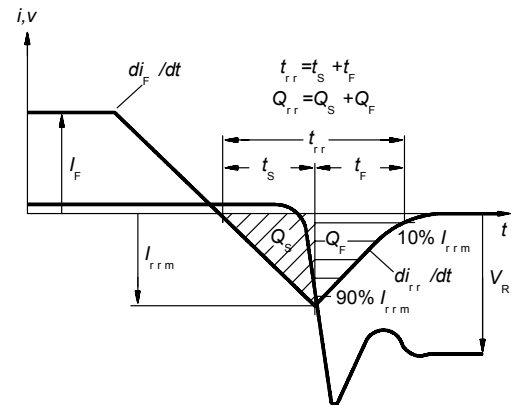


Figure C. Definition of diodes switching characteristics

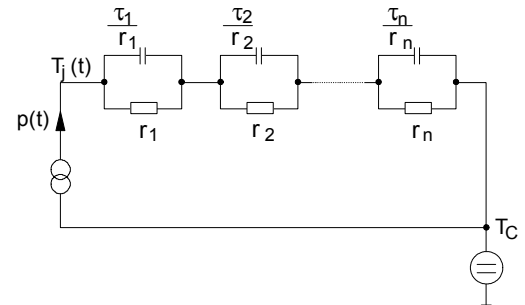


Figure D. Thermal equivalent circuit

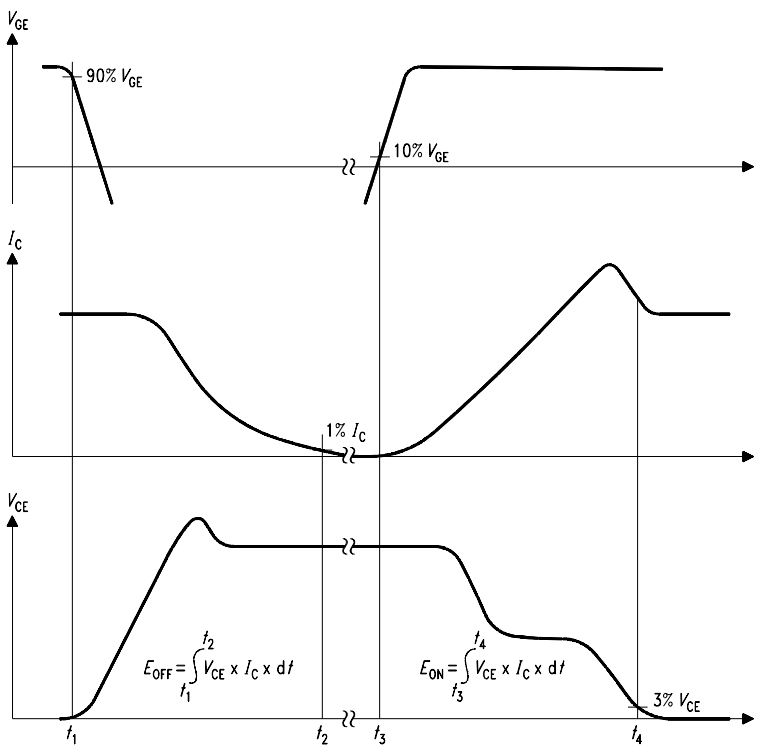


Figure B. Definition of switching losses

SIS00050

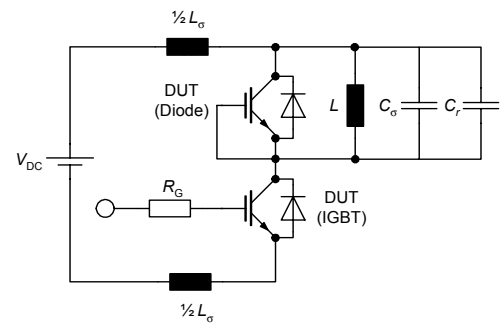


Figure E. Dynamic test circuit  
 Leakage inductance  $L_\sigma = 180\text{nH}$ ,  
 Stray capacitor  $C_\sigma = 40\text{pF}$ ,  
 Relief capacitor  $C_r = 1\text{nF}$  (only for ZVT switching)

**Edition 2006-01**

**Published by  
Infineon Technologies AG  
81726 München, Germany**

**© Infineon Technologies AG 9/13/07.**

**All Rights Reserved.**

**Attention please!**

The information given in this data sheet shall in no event be regarded as a guarantee of conditions or characteristics ("Beschaffenheitsgarantie"). With respect to any examples or hints given herein, any typical values stated herein and/or any information regarding the application of the device, Infineon Technologies hereby disclaims any and all warranties and liabilities of any kind, including without limitation warranties of non-infringement of intellectual property rights of any third party.

**Information**

For further information on technology, delivery terms and conditions and prices please contact your nearest Infineon Technologies Office ([www.infineon.com](http://www.infineon.com)).

**Warnings**

Due to technical requirements components may contain dangerous substances. For information on the types in question please contact your nearest Infineon Technologies Office.

Infineon Technologies Components may only be used in life-support devices or systems with the express written approval of Infineon Technologies, if a failure of such components can reasonably be expected to cause the failure of that life-support device or system, or to affect the safety or effectiveness of that device or system. Life support devices or systems are intended to be implanted in the human body, or to support and/or maintain and sustain and/or protect human life. If they fail, it is reasonable to assume that the health of the user or other persons may be endangered.