

Reverse Conducting IGBT with monolithic body diode

Features:

- 1.5V Forward voltage of monolithic body Diode
- Full Current Rating of monolithic body Diode
- Specified for $T_{jmax} = 175^{\circ}\text{C}$
- Trench and Fieldstop technology for 1000 V applications offers :
 - very tight parameter distribution
 - high ruggedness, temperature stable behavior
 - easy parallel switching capability due to positive temperature coefficient in $V_{CE(sat)}$
- Low EMI
- Qualified according to JEDEC¹ for target applications
- Pb-free lead plating; RoHS compliant

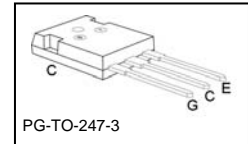
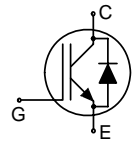

Applications:

- Microwave Oven
- Soft Switching Applications

| Type | V_{CE} | I_C | $V_{CE(sat), T_j=25^{\circ}\text{C}}$ | $T_{j,max}$ | Marking | Package |
|------------|----------|-------|---------------------------------------|-------------|---------|-------------|
| IHW30N100R | 1000V | 30A | 1.5V | 175°C | H30R100 | PG-TO-247-3 |

Maximum Ratings

| Parameter | Symbol | Value | Unit |
|--|-------------|------------|------|
| Collector-emitter voltage | V_{CE} | 1000 | V |
| DC collector current | I_C | 60 30 | A |
| $T_C = 25^{\circ}\text{C}$ | | | |
| $T_C = 100^{\circ}\text{C}$ | | | |
| Pulsed collector current, t_p limited by T_{jmax} | I_{Cpuls} | 90 | |
| Turn off safe operating area $V_{CE} \leq 1000\text{V}$, $T_j \leq 175^{\circ}\text{C}$ | - | 90 | |
| Diode forward current | I_F | 60 30 | |
| $T_C = 25^{\circ}\text{C}$ | | | |
| $T_C = 100^{\circ}\text{C}$ | | | |
| Diode pulsed current, t_p limited by T_{jmax} | I_{Fpuls} | 90 | |
| Gate-emitter voltage | V_{GE} | ± 20 | V |
| Transient Gate-emitter voltage ($t_p < 5$ ms) | | ± 25 | |
| Power dissipation, $T_C = 25^{\circ}\text{C}$ | P_{tot} | 412 | W |
| Operating junction temperature | T_j | -40...+175 | °C |
| Storage temperature | T_{stg} | -55...+175 | °C |
| Soldering temperature, 1.6mm (0.063 in.) from case for 10s | - | 260 | |

¹ J-STD-020 and JESD-022

Thermal Resistance

| Parameter | Symbol | Conditions | Max. Value | Unit |
|---|-------------|------------|------------|------|
| Characteristic | | | | |
| IGBT thermal resistance, junction – case | R_{thJC} | | 0.36 | K/W |
| Diode thermal resistance, junction – case | R_{thJCD} | | 0.36 | |
| Thermal resistance, junction – ambient | R_{thJA} | | 40 | |

Electrical Characteristic, at $T_j = 25^\circ\text{C}$, unless otherwise specified

| Parameter | Symbol | Conditions | Value | | | Unit |
|--------------------------------------|---------------|---|-------|------|------|---------|
| | | | min. | Typ. | max. | |
| Static Characteristic | | | | | | |
| Collector-emitter breakdown voltage | $V_{(BR)CES}$ | $V_{GE}=0V, I_C=500\mu A$ | 1000 | - | - | V |
| Collector-emitter saturation voltage | $V_{CE(sat)}$ | $V_{GE} = 15V, I_C=30A$ $T_j=25^\circ\text{C}$ $T_j=150^\circ\text{C}$ $T_j=175^\circ\text{C}$ | - | 1.5 | 1.7 | |
| | | | - | 1.7 | - | |
| Diode forward voltage | V_F | $V_{GE}=0V, I_F=30A$ $T_j=25^\circ\text{C}$ $T_j=150^\circ\text{C}$ $T_j=175^\circ\text{C}$ | - | 1.5 | 1.7 | |
| | | | - | 1.65 | - | |
| | | | - | 1.7 | - | |
| Gate-emitter threshold voltage | $V_{GE(th)}$ | $I_C=700\mu A, V_{CE}=V_{GE}$ | 5.1 | 5.8 | 6.4 | |
| Zero gate voltage collector current | I_{CES} | $V_{CE}=1000V, V_{GE}=0V$ $T_j=25^\circ\text{C}$ $T_j=175^\circ\text{C}$ | - | - | 5 | μA |
| | | | - | - | 2500 | |
| Gate-emitter leakage current | I_{GES} | $V_{CE}=0V, V_{GE}=20V$ | - | - | 600 | nA |
| Transconductance | g_{fs} | $V_{CE}=20V, I_C=30A$ | - | 56 | - | S |

Dynamic Characteristic

| | | | | | | |
|--|------------|--|---|------|---|----|
| Input capacitance | C_{iss} | $V_{CE}=25V,$ $V_{GE}=0V,$ $f=1\text{MHz}$ | - | 2791 | - | pF |
| Output capacitance | C_{oss} | | - | 82 | - | |
| Reverse transfer capacitance | C_{rss} | | - | 78 | - | |
| Gate charge | Q_{Gate} | $V_{CC}=800V, I_C=30A$ $V_{GE}=15V$ | - | 209 | - | nC |
| Internal emitter inductance measured 5mm (0.197 in.) from case | L_E | | - | 13 | - | nH |

Switching Characteristic, Inductive Load, at $T_j=25^\circ\text{C}$

| Parameter | Symbol | Conditions | Value | | | Unit |
|----------------------------|---------------------|--|-------|------|------|------|
| | | | min. | Typ. | max. | |
| IGBT Characteristic | | | | | | |
| Turn-off delay time | $t_{d(\text{off})}$ | $T_j=25^\circ\text{C}$, $V_{\text{CC}}=600\text{V}$, $I_{\text{C}}=30\text{A}$, $V_{\text{GE}}=0/15\text{V}$, $R_{\text{G}}=26\Omega$, | - | 846 | - | mJ |
| Fall time | t_f | | - | 33.3 | - | |
| Turn-on energy | E_{on} | | - | - | - | |
| Turn-off energy | E_{off} | | - | 2.1 | - | |
| Total switching energy | E_{ts} | | - | - | - | |

Switching Characteristic, Inductive Load, at $T_j=175^\circ\text{C}$

| Parameter | Symbol | Conditions | Value | | | Unit |
|----------------------------|---------------------|--|-------|------|------|------|
| | | | min. | Typ. | max. | |
| IGBT Characteristic | | | | | | |
| Turn-off delay time | $t_{d(\text{off})}$ | $T_j=175^\circ\text{C}$ $V_{\text{CC}}=600\text{V}$, $I_{\text{C}}=30\text{A}$, $V_{\text{GE}}=0/15\text{V}$, $R_{\text{G}}=26\Omega$ | - | 948 | - | mJ |
| Fall time | t_f | | - | 40.4 | - | |
| Turn-on energy | E_{on} | | - | - | - | |
| Turn-off energy | E_{off} | | - | 2.86 | - | |
| Total switching energy | E_{ts} | | - | - | - | |

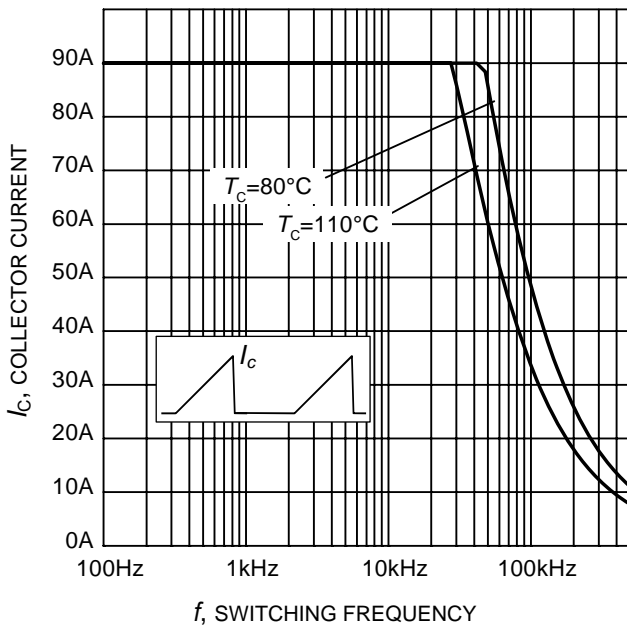

Figure 1. Collector current as a function of switching frequency for triangular current ($E_{on} = 0$, hard turn-off)
 ($T_j \leq 175^\circ\text{C}$, $D = 0.5$, $V_{CE} = 400\text{V}$, $V_{GE} = 0/+15\text{V}$, $R_G = 26\Omega$)

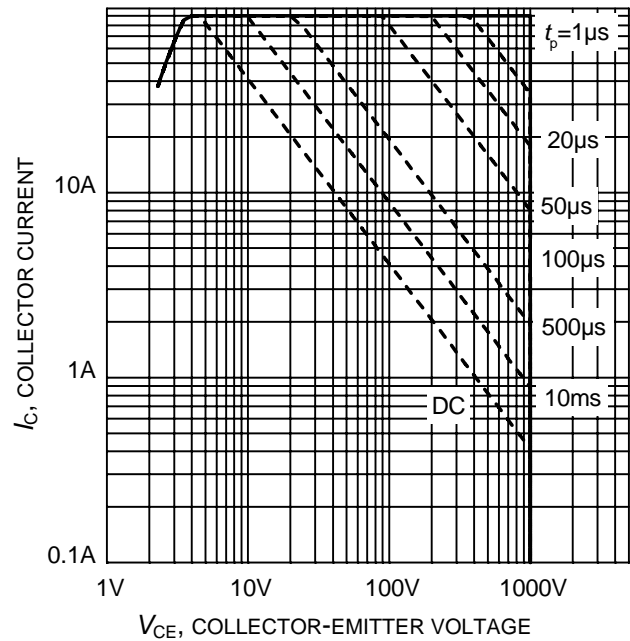

Figure 2. Safe operating area
 ($D = 0$, $T_C = 25^\circ\text{C}$, $T_j \leq 175^\circ\text{C}$; $V_{GE} = 15\text{V}$)

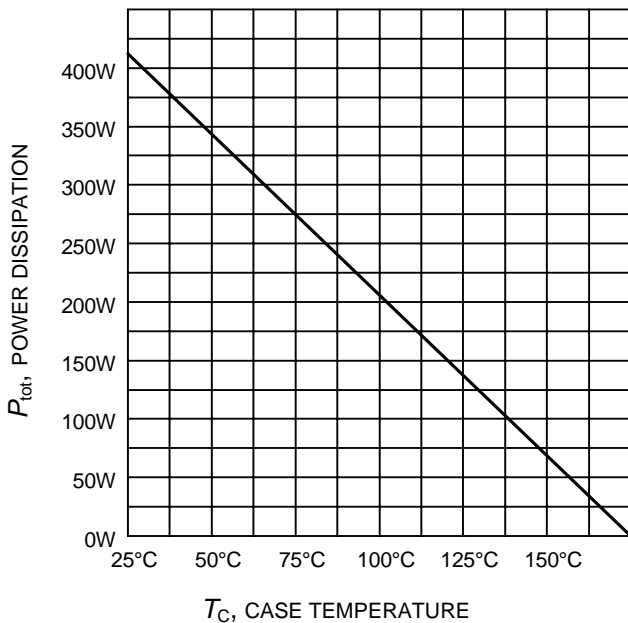

Figure 3. Power dissipation as a function of case temperature
 ($T_j \leq 175^\circ\text{C}$)

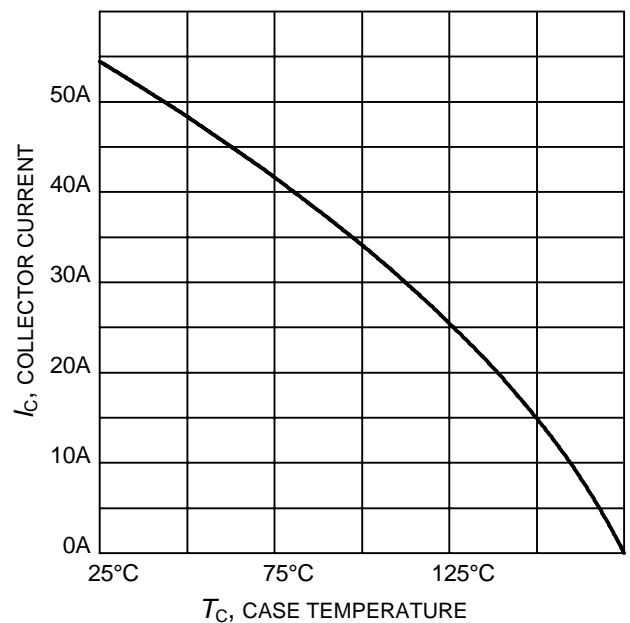

Figure 4. Collector current as a function of case temperature
 ($V_{GE} \geq 15\text{V}$, $T_j \leq 175^\circ\text{C}$)

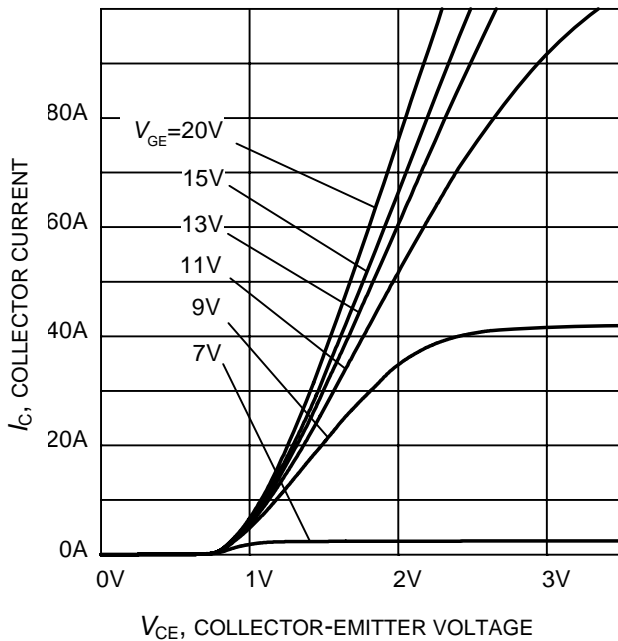

Figure 5. Typical output characteristic
($T_j = 25^\circ\text{C}$)

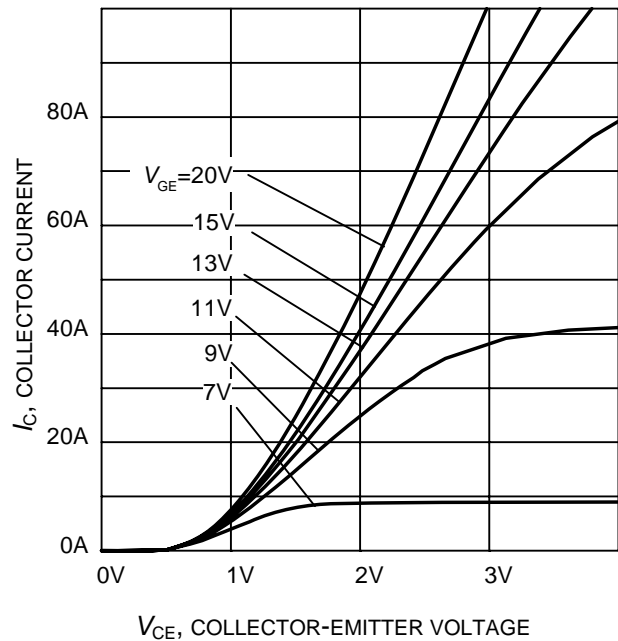

Figure 6. Typical output characteristic
($T_j = 175^\circ\text{C}$)

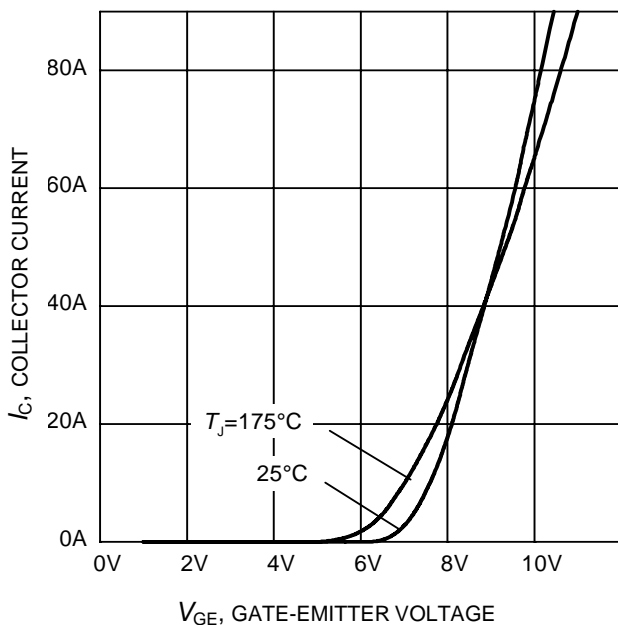

Figure 7. Typical transfer characteristic
($V_{CE} = 20\text{V}$)

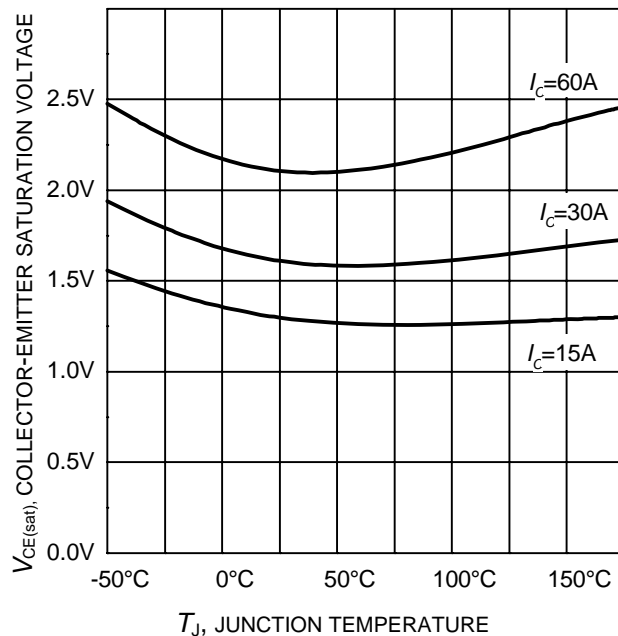

Figure 8. Typical collector-emitter saturation voltage as a function of junction temperature
($V_{GE} = 15\text{V}$)

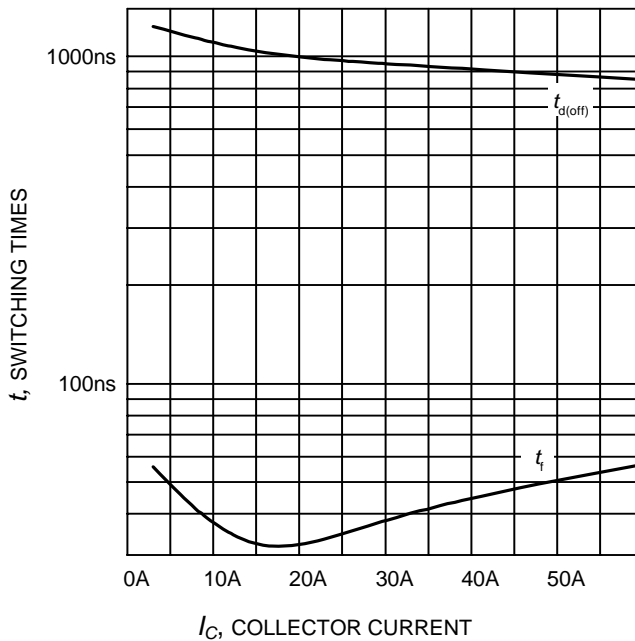

Figure 9. Typical switching times as a function of collector current
 (inductive load, $T_J=175^\circ\text{C}$,
 $V_{CE} = 600\text{V}$, $V_{GE} = 0/15\text{V}$, $R_G=26\Omega$,
 Dynamic test circuit in Figure E)

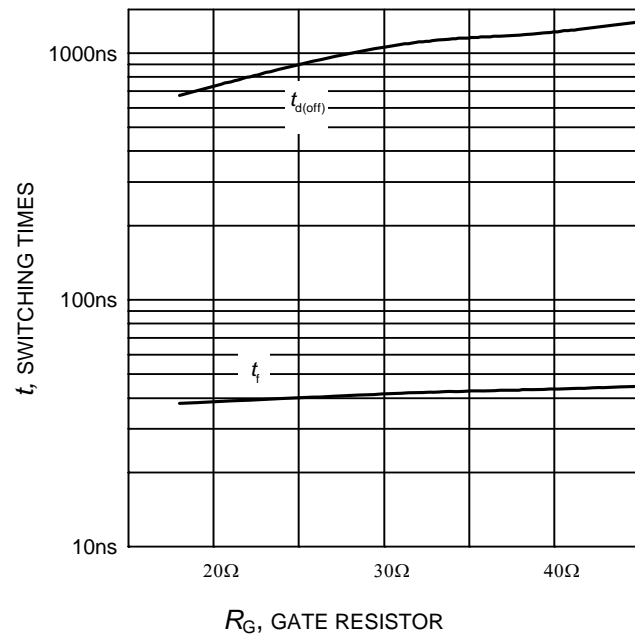

Figure 10. Typical switching times as a function of gate resistor
 (inductive load, $T_J = 175^\circ\text{C}$,
 $V_{CE} = 600\text{V}$, $V_{GE} = 0/15\text{V}$, $I_C = 30\text{A}$,
 Dynamic test circuit in Figure E)

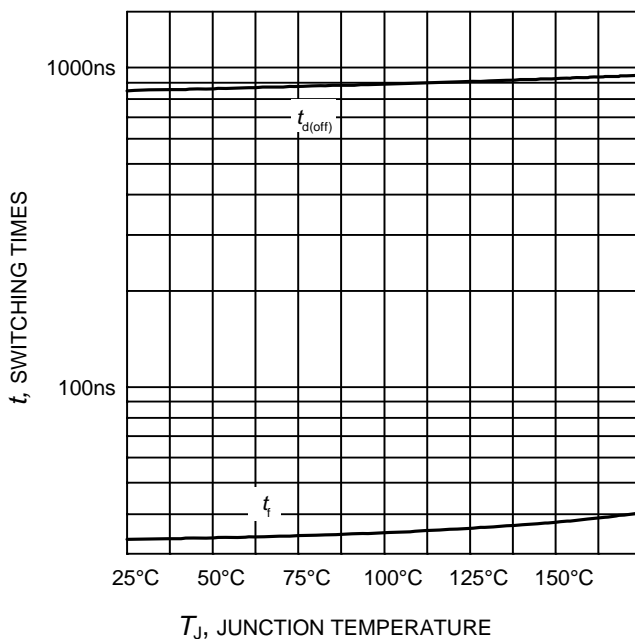

Figure 11. Typical switching times as a function of junction temperature
 (inductive load, $V_{CE} = 600\text{V}$,
 $V_{GE} = 0/15\text{V}$, $I_C = 30\text{A}$, $R_G=26\Omega$,
 Dynamic test circuit in Figure E)

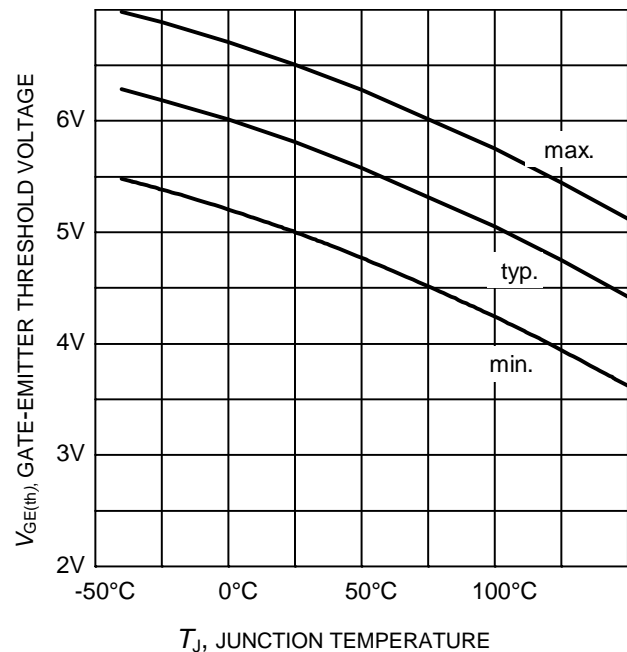

Figure 12. Gate-emitter threshold voltage as a function of junction temperature
 ($I_C = 0.7\text{mA}$)

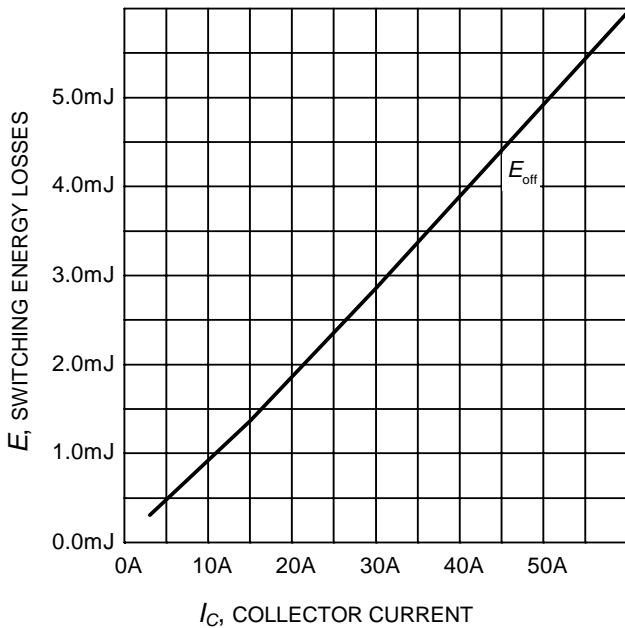

Figure 13. Typical switching energy losses as a function of collector current
 (inductive load, $T_J = 175^\circ\text{C}$, $V_{CE} = 600\text{V}$, $V_{GE} = 0/15\text{V}$, $R_G = 26\Omega$, Dynamic test circuit in Figure E)

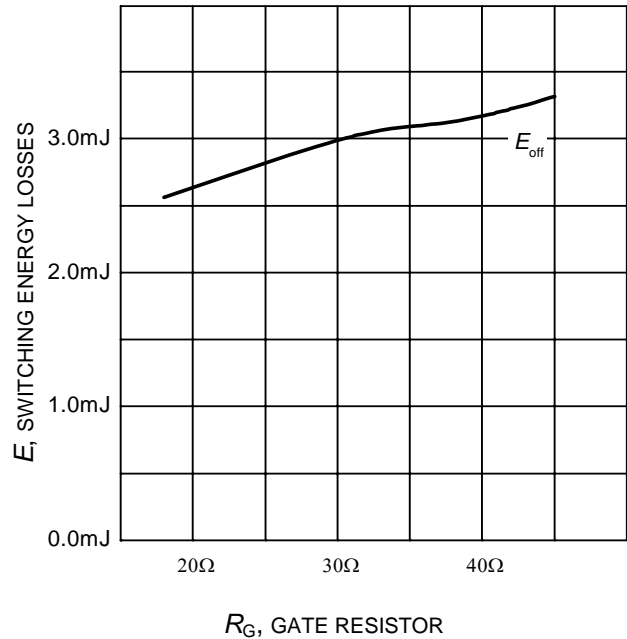

Figure 14. Typical switching energy losses as a function of gate resistor
 (inductive load, $T_J = 175^\circ\text{C}$, $V_{CE} = 600\text{V}$, $V_{GE} = 0/15\text{V}$, $I_C = 30\text{A}$, Dynamic test circuit in Figure E)

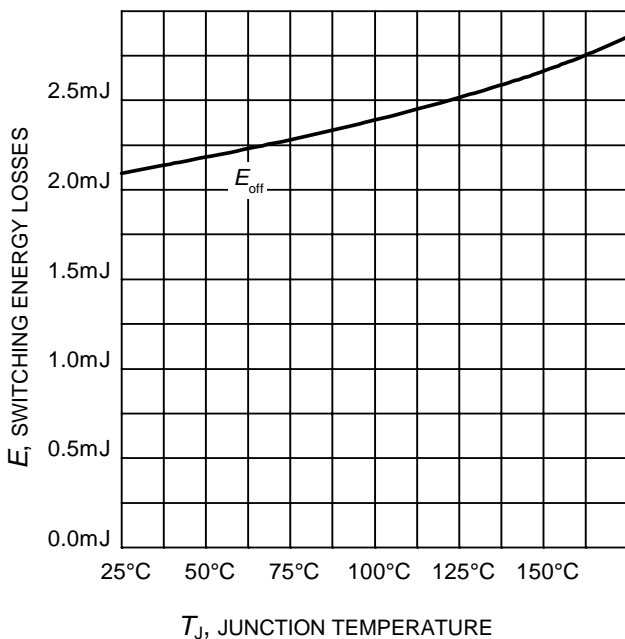

Figure 15. Typical switching energy losses as a function of junction temperature
 (inductive load, $V_{CE} = 600\text{V}$, $V_{GE} = 0/15\text{V}$, $I_C = 30\text{A}$, $R_G = 26\Omega$, Dynamic test circuit in Figure E)

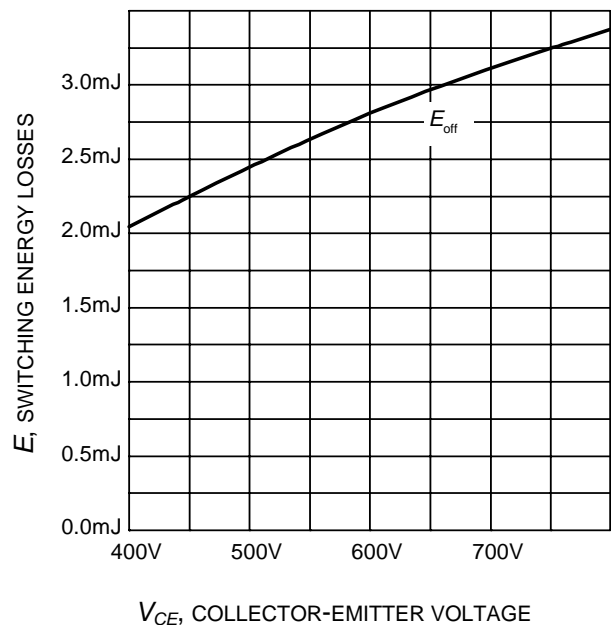

Figure 16. Typical switching energy losses as a function of collector emitter voltage
 (inductive load, $T_J = 175^\circ\text{C}$, $V_{GE} = 0/15\text{V}$, $I_C = 30\text{A}$, $R_G = 26\Omega$, Dynamic test circuit in Figure E)

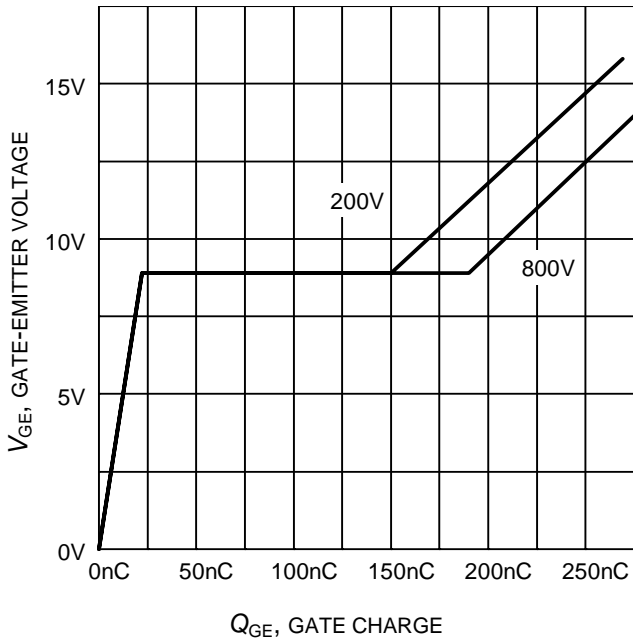

Figure 17. Typical gate charge
($I_C=30\text{ A}$)

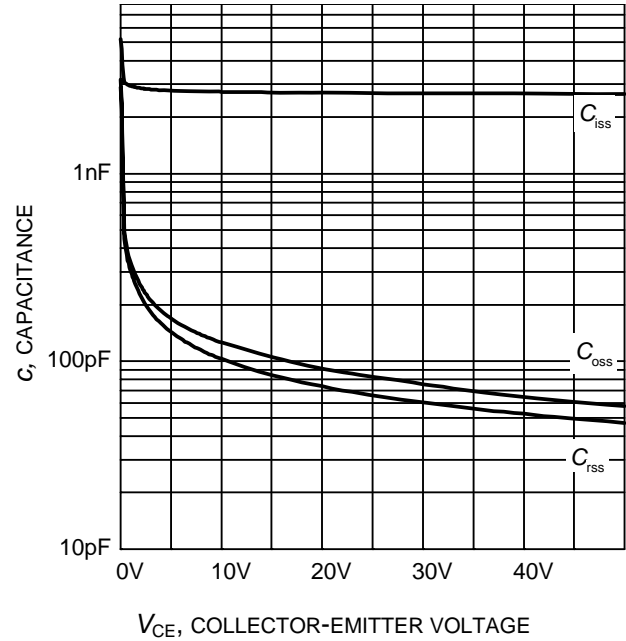

Figure 18. Typical capacitance as a function of collector-emitter voltage
($V_{GE}=0\text{V}$, $f = 1\text{ MHz}$)

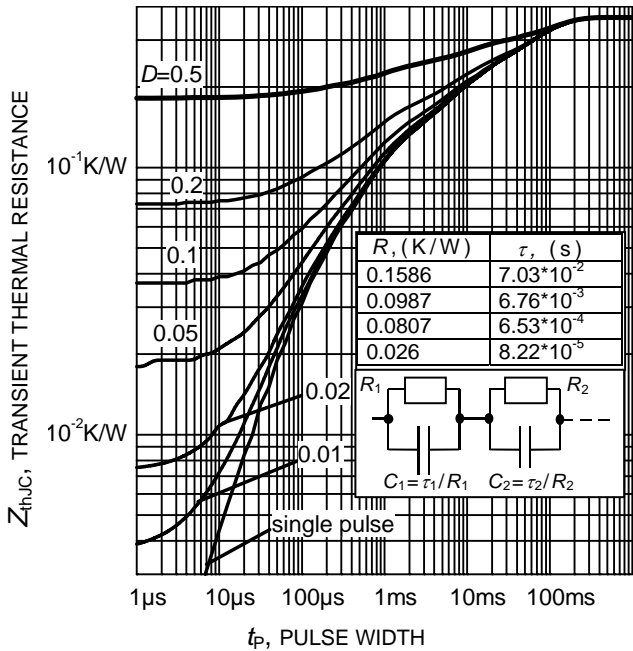

Figure 19. IGBT transient thermal resistance
($D = t_p / T$)

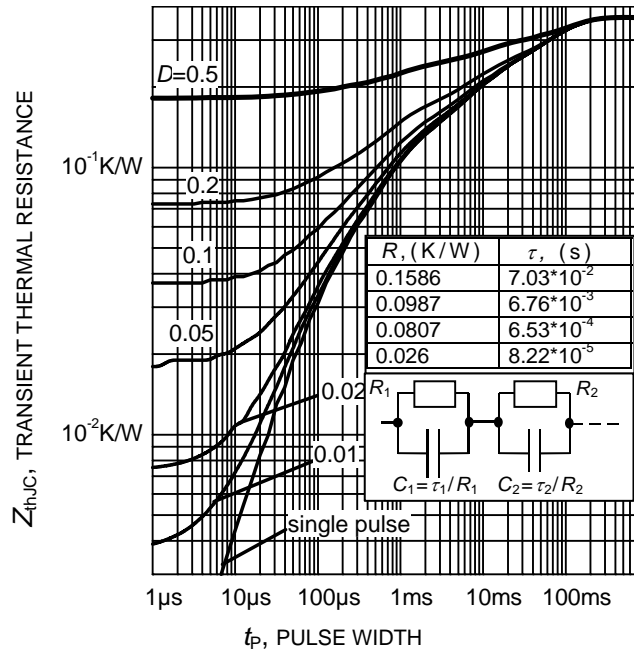

Figure 20. Diode transient thermal impedance as a function of pulse width
($D = t_p / T$)

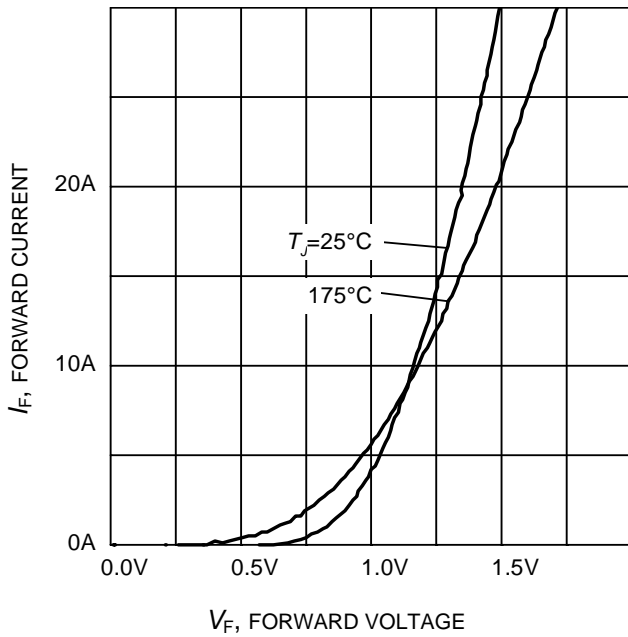

Figure 21. Typical diode forward current as a function of forward voltage

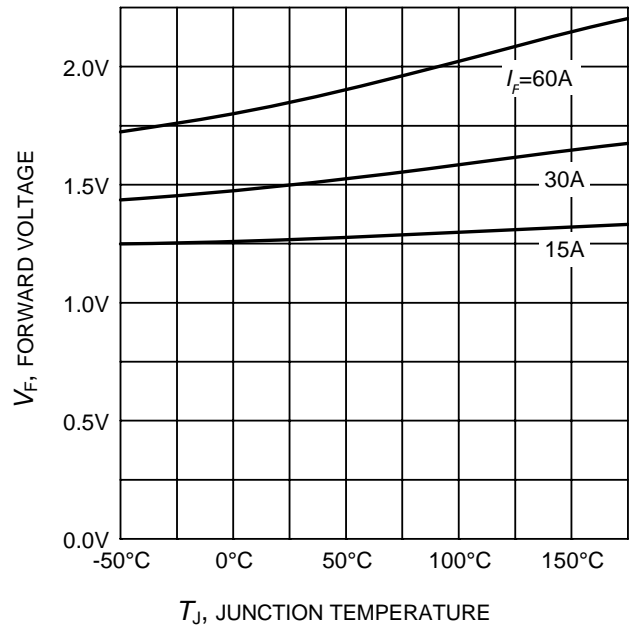
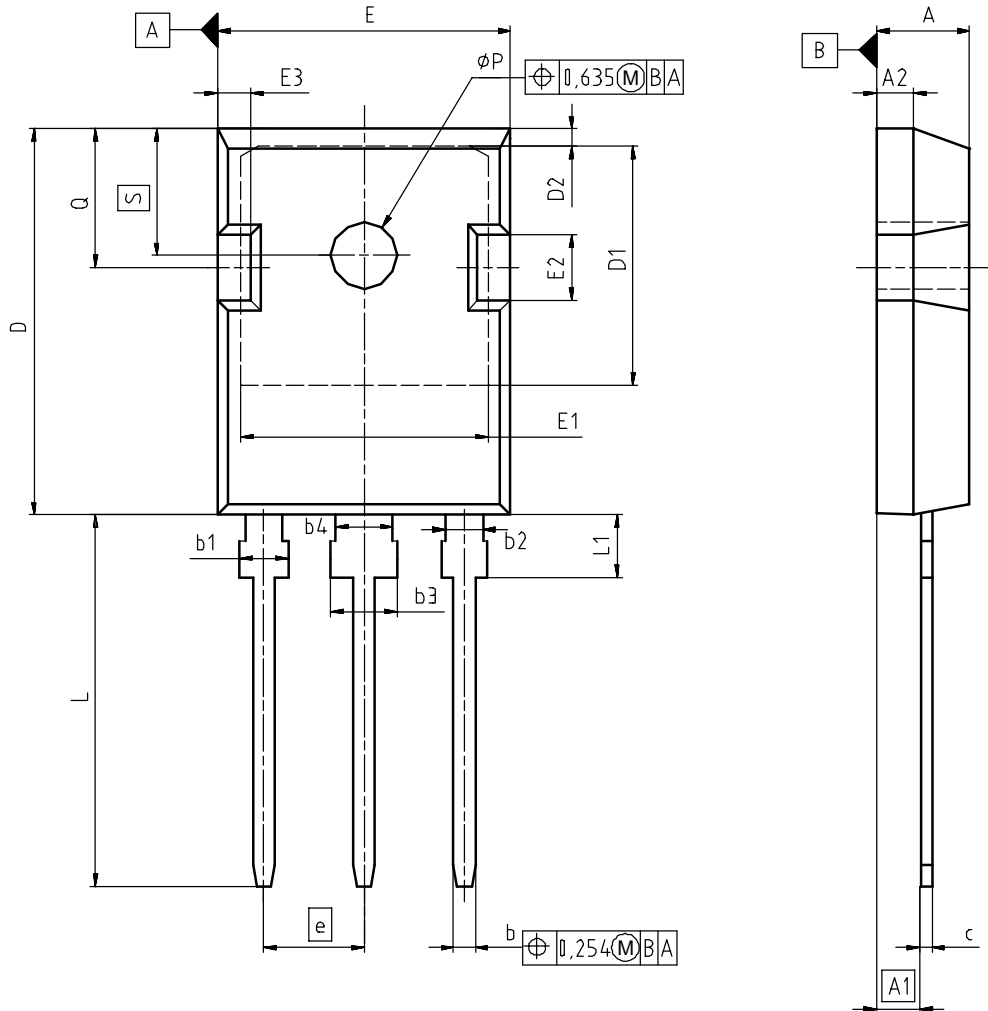

Figure 22. Typical diode forward voltage as a function of junction temperature

PG-TO247-3



| DIM | MILLIMETERS | | INCHES | |
|-----------------|-------------|-------|--------|-------|
| | MIN | MAX | MIN | MAX |
| A | 4.90 | 5.16 | 0.193 | 0.203 |
| A1 | 2.27 | 2.53 | 0.089 | 0.099 |
| A2 | 1.85 | 2.11 | 0.073 | 0.083 |
| b | 1.07 | 1.33 | 0.042 | 0.052 |
| b1 | 1.90 | 2.41 | 0.075 | 0.095 |
| b2 | 1.90 | 2.16 | 0.075 | 0.085 |
| b3 | 2.87 | 3.38 | 0.113 | 0.133 |
| b4 | 2.87 | 3.13 | 0.113 | 0.123 |
| c | 0.55 | 0.68 | 0.022 | 0.027 |
| D | 20.82 | 21.10 | 0.820 | 0.831 |
| D1 | 16.25 | 17.65 | 0.640 | 0.695 |
| D2 | 1.05 | 1.35 | 0.041 | 0.053 |
| E | 15.70 | 16.03 | 0.618 | 0.631 |
| E1 | 13.10 | 14.15 | 0.516 | 0.557 |
| E2 | 3.68 | 5.10 | 0.145 | 0.201 |
| E3 | 1.68 | 2.60 | 0.066 | 0.102 |
| e | 5.44 | | 0.214 | |
| N | 3 | | 3 | |
| L | 19.80 | 20.31 | 0.780 | 0.799 |
| L1 | 4.17 | 4.47 | 0.164 | 0.176 |
| $\varnothing P$ | 3.50 | 3.70 | 0.138 | 0.146 |
| Q | 5.49 | 6.00 | 0.216 | 0.236 |
| S | 6.04 | 6.30 | 0.238 | 0.248 |

DOCUMENT NO.
Z8B00003327

SCALE

EUROPEAN PROJECTION

ISSUE DATE
17-12-2007

REVISION
03

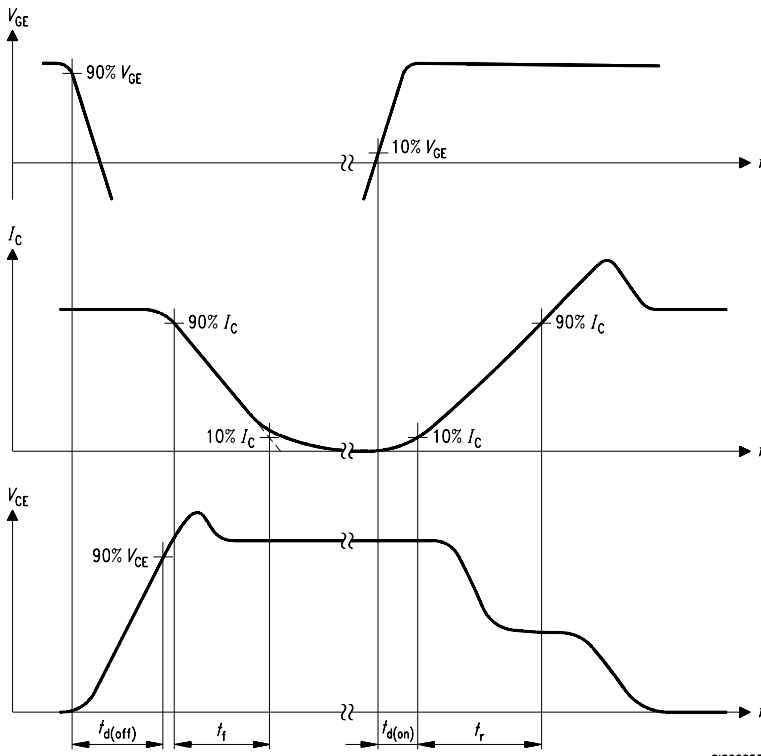

Figure A. Definition of switching times

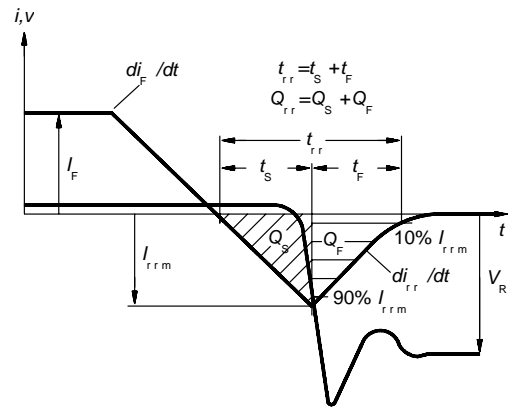

Figure C. Definition of diodes switching characteristics

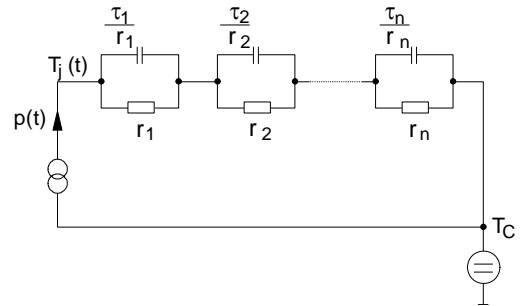

Figure D. Thermal equivalent circuit

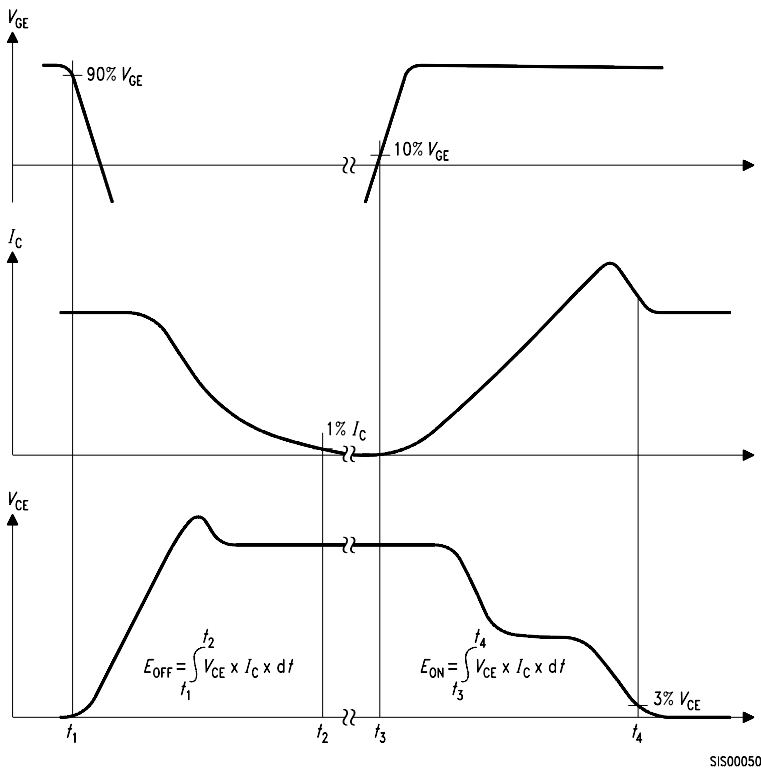

Figure B. Definition of switching losses

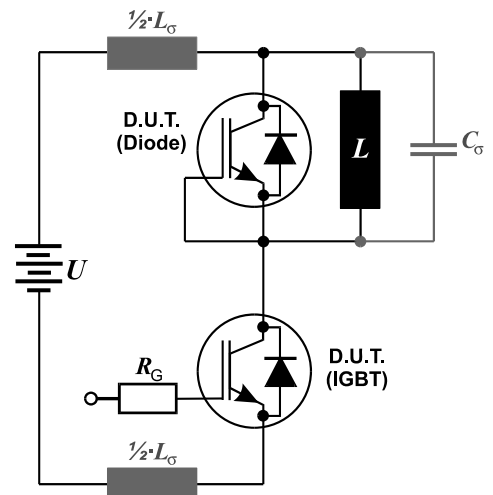

Figure E. Dynamic test circuit

Published by
Infineon Technologies AG
81726 Munich, Germany
© 2008 Infineon Technologies AG
All Rights Reserved.

Legal Disclaimer

The information given in this document shall in no event be regarded as a guarantee of conditions or characteristics. With respect to any examples or hints given herein, any typical values stated herein and/or any information regarding the application of the device, Infineon Technologies hereby disclaims any and all warranties and liabilities of any kind, including without limitation, warranties of non-infringement of intellectual property rights of any third party.

Information

For further information on technology, delivery terms and conditions and prices, please contact the nearest Infineon Technologies Office (www.infineon.com).

Warnings

Due to technical requirements, components may contain dangerous substances. For information on the types in question, please contact the nearest Infineon Technologies Office. Infineon Technologies components may be used in life-support devices or systems only with the express written approval of Infineon Technologies, if a failure of such components can reasonably be expected to cause the failure of that life-support device or system or to affect the safety or effectiveness of that device or system. Life support devices or systems are intended to be implanted in the human body or to support and/or maintain and sustain and/or protect human life. If they fail, it is reasonable to assume that the health of the user or other persons may be endangered.