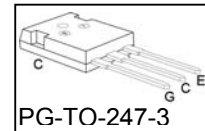
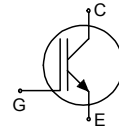


## Low Loss IGBT in TrenchStop® and Fieldstop technology

- Approx. 1.0V reduced  $V_{CE(sat)}$  compared to BUP313
- Short circuit withstand time – 10 $\mu$ s
- Designed for :
  - Frequency Converters
  - Uninterrupted Power Supply
- TrenchStop® and Fieldstop technology for 1200 V applications offers :
  - very tight parameter distribution
  - high ruggedness, temperature stable behavior
- NPT technology offers easy parallel switching capability due to positive temperature coefficient in  $V_{CE(sat)}$
- Low EMI
- Low Gate Charge
- Qualified according to JEDEC<sup>1</sup> for target applications
- Pb-free lead plating; RoHS compliant
- Complete product spectrum and PSpice Models : <http://www.infineon.com/igbt/>



| Type      | $V_{CE}$ | $I_C$ | $V_{CE(sat), T_J=25^\circ C}$ | $T_{j,max}$ | Marking Code | Package     |
|-----------|----------|-------|-------------------------------|-------------|--------------|-------------|
| IGW15T120 | 1200V    | 15A   | 1.7V                          | 150°C       | G15T120      | PG-TO-247-3 |

**Maximum Ratings**

| Parameter  | Symbol       | Value      | Unit    |
|--|--------------|------------|---------|
| Collector-emitter voltage                                  | $V_{CE}$     | 1200       | V       |
| DC collector current                                       | $I_C$        |            | A       |
| $T_C = 25^\circ C$   |              | 30         |         |
| $T_C = 100^\circ C$  |              | 15         |         |
| Pulsed collector current, $t_p$ limited by $T_{j,max}$     | $I_{C,puls}$ | 45         |         |
| Turn off safe operating area                               | -            | 45         |         |
| $V_{CE} \leq 1200V, T_j \leq 150^\circ C$                  |              |            |         |
| Gate-emitter voltage                                       | $V_{GE}$     | $\pm 20$   | V       |
| Short circuit withstand time <sup>2)</sup>                 | $t_{SC}$     | 10         | $\mu s$ |
| $V_{GE} = 15V, V_{CC} \leq 1200V, T_j \leq 150^\circ C$    |              |            |         |
| Power dissipation  | $P_{tot}$    | 110        | W       |
| $T_C = 25^\circ C$   |              |            |         |
| Operating junction temperature                             | $T_j$        | -40...+150 | °C      |
| Storage temperature  | $T_{stg}$    | -55...+150 |         |
| Soldering temperature, 1.6mm (0.063 in.) from case for 10s | -            | 260        |         |

<sup>1</sup> J-STD-020 and JEDEC-022

<sup>2)</sup> Allowed number of short circuits: <1000; time between short circuits: >1s.

**Thermal Resistance**

| Parameter                                | Symbol     | Conditions | Max. Value | Unit |
|--|------------|------------|------------|------|
| <b>Characteristic</b>                    |            |            |            |      |
| IGBT thermal resistance, junction – case | $R_{thJC}$ |            | 1.1        | K/W  |
| Thermal resistance, junction – ambient   | $R_{thJA}$ |            | 40         |      |

**Electrical Characteristic, at  $T_j = 25^\circ\text{C}$ , unless otherwise specified**

| Parameter                            | Symbol        | Conditions                 | Value |      |      | Unit     |
|--------------------------------------|---------------|----------------------------|-------|------|------|----------|
|                                      |               |                            | min.  | typ. | max. |          |
| <b>Static Characteristic</b>         |               |                            |       |      |      |          |
| Collector-emitter breakdown voltage  | $V_{(BR)CES}$ | $V_{GE}=0V, I_C=0.5mA$     | 1200  | -    | -    | V        |
| Collector-emitter saturation voltage | $V_{CE(sat)}$ | $V_{GE} = 15V, I_C=15A$    | -     | 1.7  | 2.2  |          |
|                                      |               | $T_j=125^\circ\text{C}$    | -     | 2.0  | -    |          |
|                                      |               | $T_j=150^\circ\text{C}$    | -     | 2.2  | -    |          |
| Gate-emitter threshold voltage       | $V_{GE(th)}$  | $I_C=0.6mA, V_{CE}=V_{GE}$ | 5.0   | 5.8  | 6.5  |          |
| Zero gate voltage collector current  | $I_{CES}$     | $V_{CE}=1200V, V_{GE}=0V$  |       |      |      | mA       |
|                                      |               | $T_j=25^\circ\text{C}$     | -     | -    | 0.2  |          |
|                                      |               | $T_j=150^\circ\text{C}$    | -     | -    | 2.0  |          |
| Gate-emitter leakage current         | $I_{GES}$     | $V_{CE}=0V, V_{GE}=20V$    | -     | -    | 100  | nA       |
| Transconductance                     | $g_{fs}$      | $V_{CE}=20V, I_C=15A$      | -     | 10   | -    | S        |
| Integrated gate resistor             | $R_{Gint}$    |                            | none  |      |      | $\Omega$ |

**Dynamic Characteristic**

|  |             |  |   |      |   |    |
|--|-------------|--|---|------|---|----|
| Input capacitance  | $C_{iss}$   | $V_{CE}=25V,$  | - | 1100 | - | pF |
| Output capacitance   | $C_{oss}$   | $V_{GE}=0V,$   | - | 100  | - |    |
| Reverse transfer capacitance                                   | $C_{riss}$  | $f=1MHz$   | - | 50   | - |    |
| Gate charge  | $Q_{Gate}$  | $V_{CC}=960V, I_C=15A$<br>$V_{GE}=15V$                                       | - | 85   | - | nC |
| Internal emitter inductance measured 5mm (0.197 in.) from case | $L_E$       |  | - | 13   | - | nH |
| Short circuit collector current <sup>1)</sup>                  | $I_{C(SC)}$ | $V_{GE}=15V, t_{SC}\leq 10\mu s$<br>$V_{CC}=600V,$<br>$T_j=25^\circ\text{C}$ | - | 90   | - | A  |

<sup>1)</sup> Allowed number of short circuits: <1000; time between short circuits: >1s.

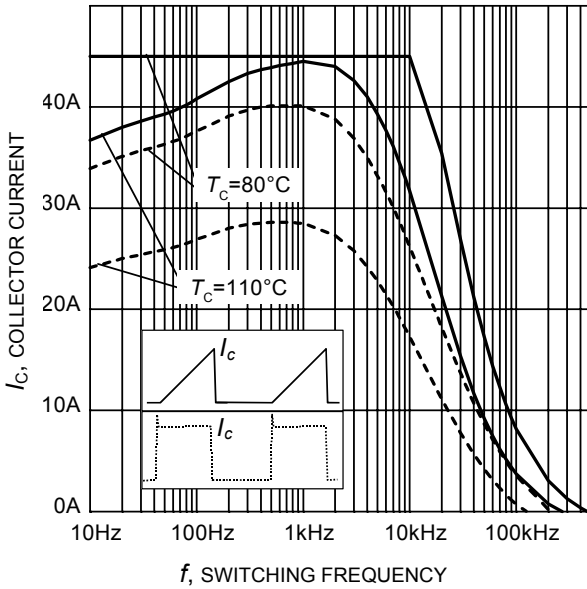
**Switching Characteristic, Inductive Load, at  $T_j=25^\circ\text{C}$** 

| Parameter                  | Symbol       | Conditions  | Value |      |      | Unit |
|----------------------------|--------------|---|-------|------|------|------|
|                            |              |   | min.  | typ. | max. |      |
| <b>IGBT Characteristic</b> |              |   |       |      |      |      |
| Turn-on delay time         | $t_{d(on)}$  | $T_j=25^\circ\text{C}$ ,<br>$V_{CC}=600\text{V}$ , $I_C=15\text{A}$ ,<br>$V_{GE}=0/15\text{V}$ ,<br>$R_G=56\Omega$ ,<br>$L_{\sigma}^{2)}=180\text{nH}$ ,<br>$C_{\sigma}^{2)}=39\text{pF}$<br>Energy losses include<br>"tail" and diode<br>reverse recovery. | -     | 50   | -    | ns   |
| Rise time                  | $t_r$        |   | -     | 30   | -    |      |
| Turn-off delay time        | $t_{d(off)}$ |   | -     | 520  | -    |      |
| Fall time                  | $t_f$        |   | -     | 60   | -    |      |
| Turn-on energy             | $E_{on}$     |   | -     | 1.3  | -    | mJ   |
| Turn-off energy            | $E_{off}$    |   | -     | 1.4  | -    |      |
| Total switching energy     | $E_{ts}$     |   | -     | 2.7  | -    |      |

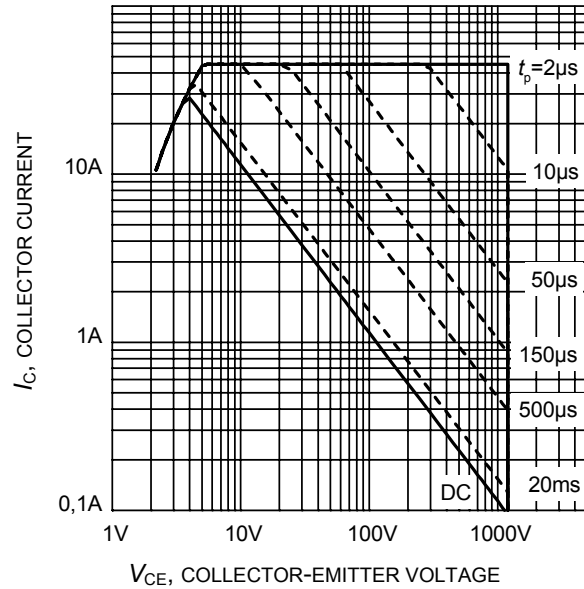
**Switching Characteristic, Inductive Load, at  $T_j=150^\circ\text{C}$** 

| Parameter                  | Symbol       | Conditions   | Value |      |      | Unit |
|----------------------------|--------------|--|-------|------|------|------|
|                            |              |  | min.  | typ. | max. |      |
| <b>IGBT Characteristic</b> |              |  |       |      |      |      |
| Turn-on delay time         | $t_{d(on)}$  | $T_j=150^\circ\text{C}$ ,<br>$V_{CC}=600\text{V}$ , $I_C=15\text{A}$ ,<br>$V_{GE}=0/15\text{V}$ ,<br>$R_G=56\Omega$ ,<br>$L_{\sigma}^{2)}=180\text{nH}$ ,<br>$C_{\sigma}^{2)}=39\text{pF}$<br>Energy losses include<br>"tail" and diode<br>reverse recovery. | -     | 50   | -    | ns   |
| Rise time                  | $t_r$        |  | -     | 35   | -    |      |
| Turn-off delay time        | $t_{d(off)}$ |  | -     | 600  | -    |      |
| Fall time                  | $t_f$        |  | -     | 120  | -    |      |
| Turn-on energy             | $E_{on}$     |  | -     | 2.0  | -    | mJ   |
| Turn-off energy            | $E_{off}$    |  | -     | 2.1  | -    |      |
| Total switching energy     | $E_{ts}$     |  | -     | 4.1  | -    |      |

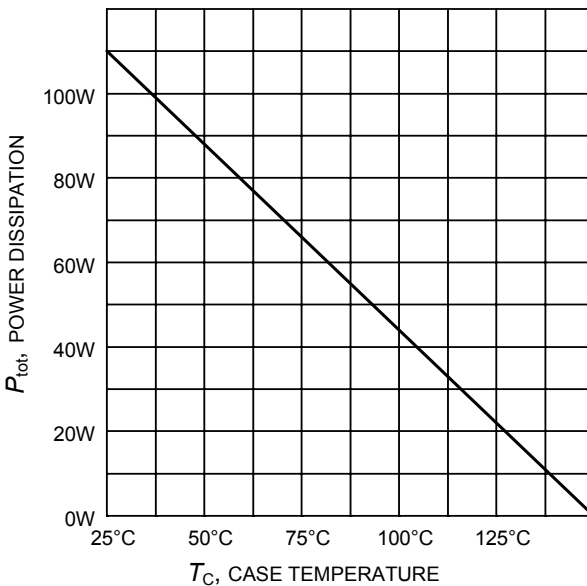
<sup>2)</sup> Leakage inductance  $L_{\sigma}$  and Stray capacity  $C_{\sigma}$  due to dynamic test circuit in Figure E.



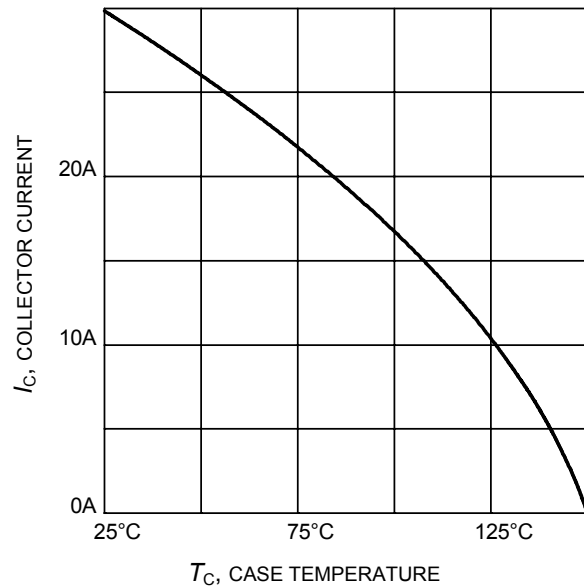
**Figure 1. Collector current as a function of switching frequency**  
 ( $T_j \leq 150^\circ\text{C}$ ,  $D = 0.5$ ,  $V_{CE} = 600\text{V}$ ,  
 $V_{GE} = 0/+15\text{V}$ ,  $R_G = 56\Omega$ )



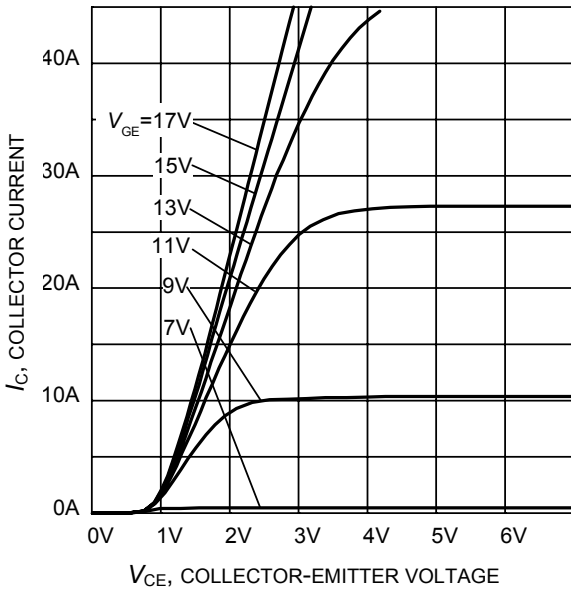
**Figure 2. Safe operating area**  
 ( $D = 0$ ,  $T_C = 25^\circ\text{C}$ ,  
 $T_j \leq 150^\circ\text{C}$ ;  $V_{GE} = 15\text{V}$ )



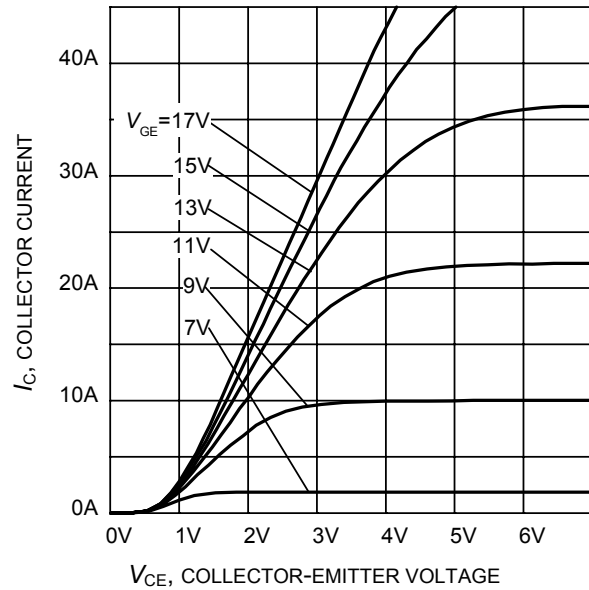
**Figure 3. Power dissipation as a function of case temperature**  
 ( $T_j \leq 150^\circ\text{C}$ )



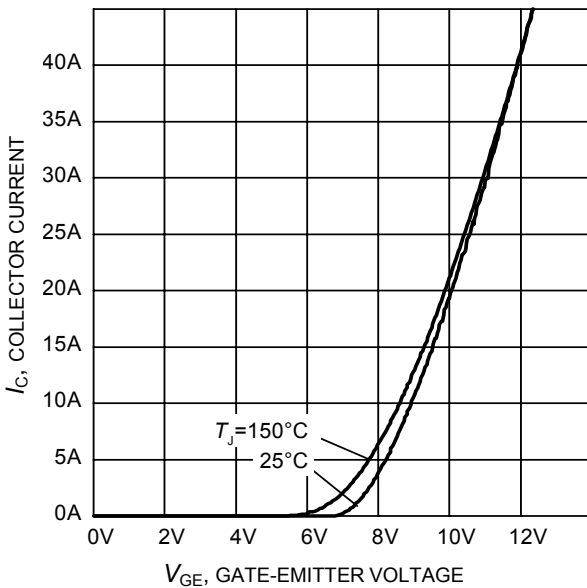
**Figure 4. Collector current as a function of case temperature**  
 ( $V_{GE} \geq 15\text{V}$ ,  $T_j \leq 150^\circ\text{C}$ )



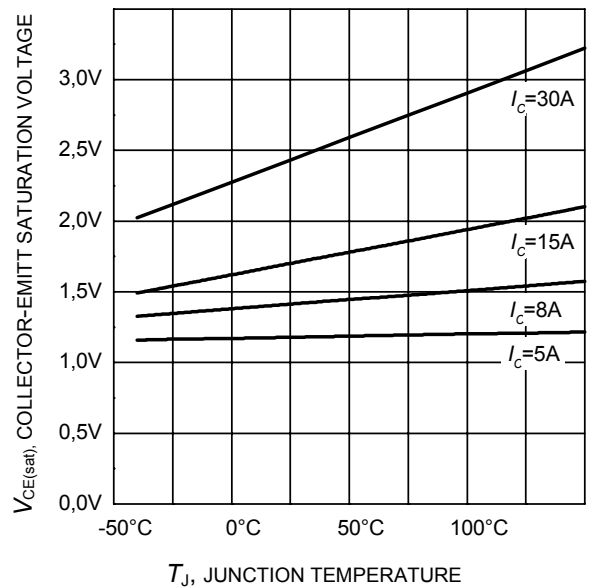
**Figure 5. Typical output characteristic**  
( $T_j = 25^\circ\text{C}$ )



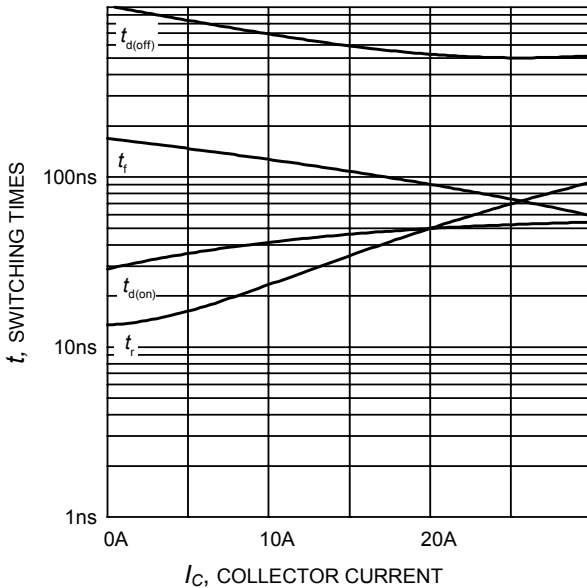
**Figure 6. Typical output characteristic**  
( $T_j = 150^\circ\text{C}$ )



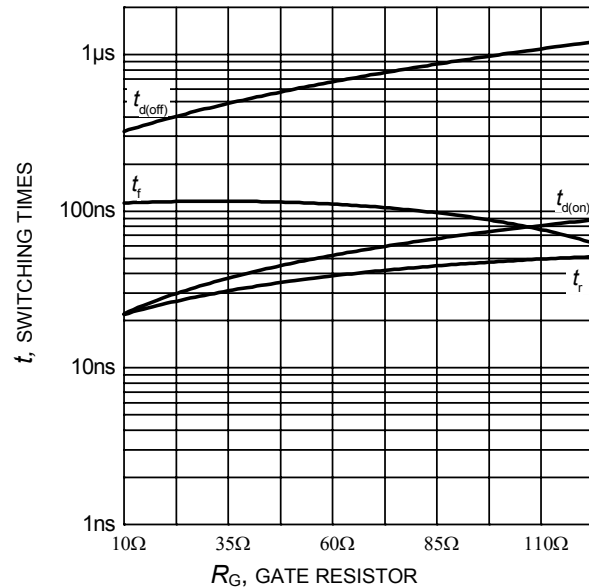
**Figure 7. Typical transfer characteristic**  
( $V_{CE} = 20\text{V}$ )



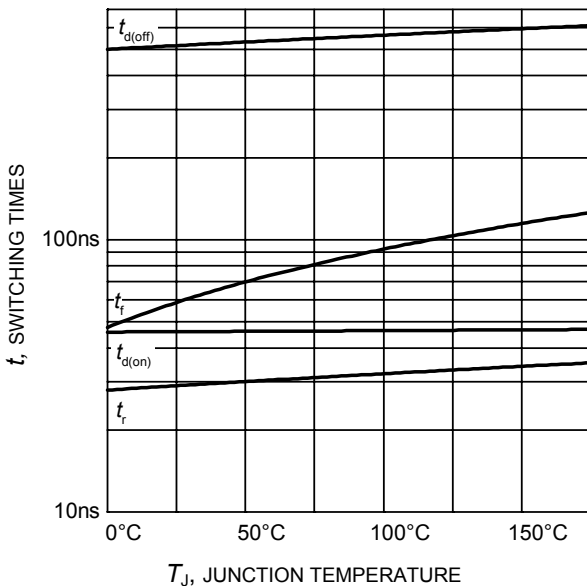
**Figure 8. Typical collector-emitter saturation voltage as a function of junction temperature**  
( $V_{GE} = 15\text{V}$ )



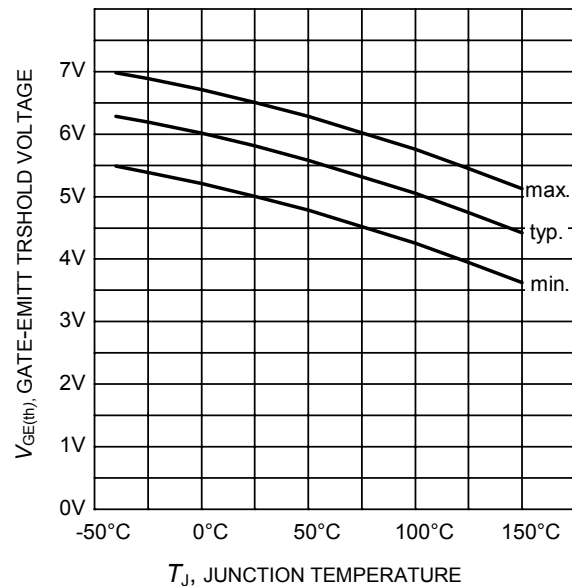
**Figure 9. Typical switching times as a function of collector current**  
 (inductive load,  $T_J=150^{\circ}\text{C}$ ,  
 $V_{CE}=600\text{V}$ ,  $V_{GE}=0/15\text{V}$ ,  $R_G=56\Omega$ ,  
 Dynamic test circuit in Figure E)



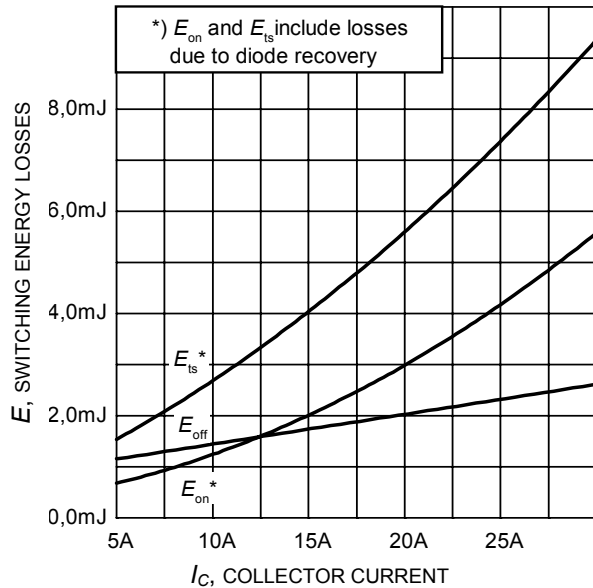
**Figure 10. Typical switching times as a function of gate resistor**  
 (inductive load,  $T_J=150^{\circ}\text{C}$ ,  
 $V_{CE}=600\text{V}$ ,  $V_{GE}=0/15\text{V}$ ,  $I_C=15\text{A}$ ,  
 Dynamic test circuit in Figure E)



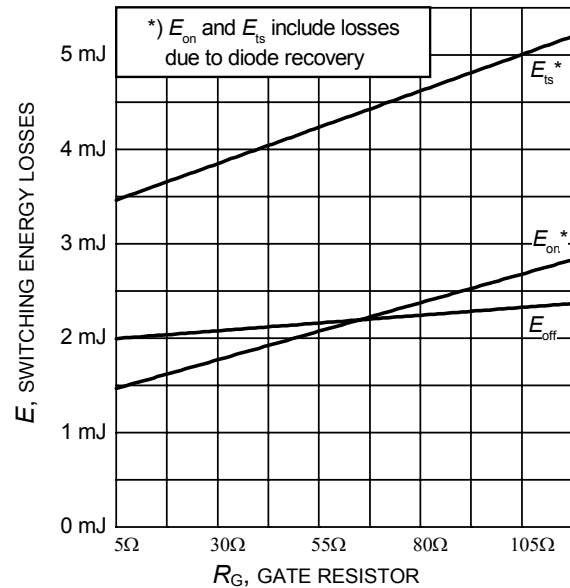
**Figure 11. Typical switching times as a function of junction temperature**  
 (inductive load,  $V_{CE}=600\text{V}$ ,  
 $V_{GE}=0/15\text{V}$ ,  $I_C=15\text{A}$ ,  $R_G=56\Omega$ ,  
 Dynamic test circuit in Figure E)



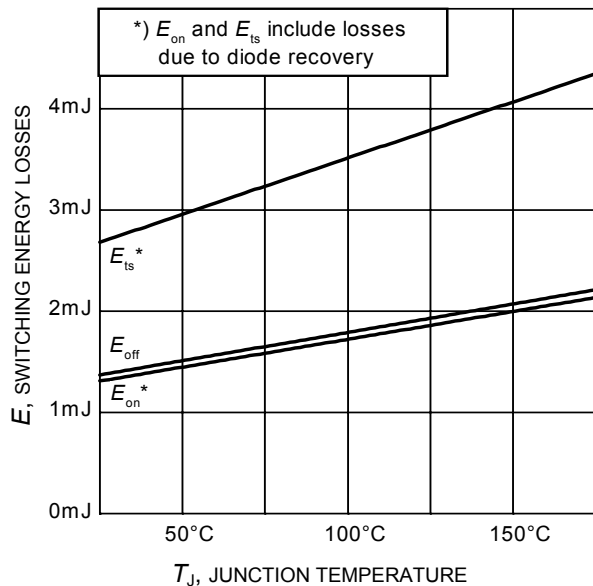
**Figure 12. Gate-emitter threshold voltage as a function of junction temperature**  
 ( $I_C = 0.6\text{mA}$ )



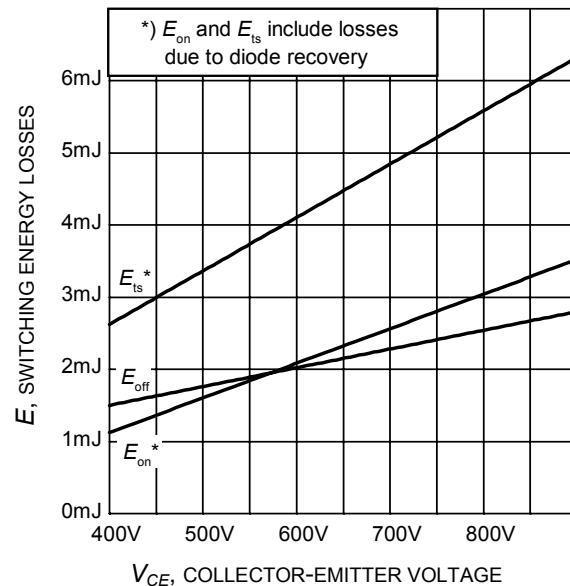
**Figure 13. Typical switching energy losses as a function of collector current**  
 (inductive load,  $T_J=150^\circ\text{C}$ ,  $V_{CE}=600\text{V}$ ,  $V_{GE}=0/15\text{V}$ ,  $R_G=56\Omega$ , Dynamic test circuit in Figure E)



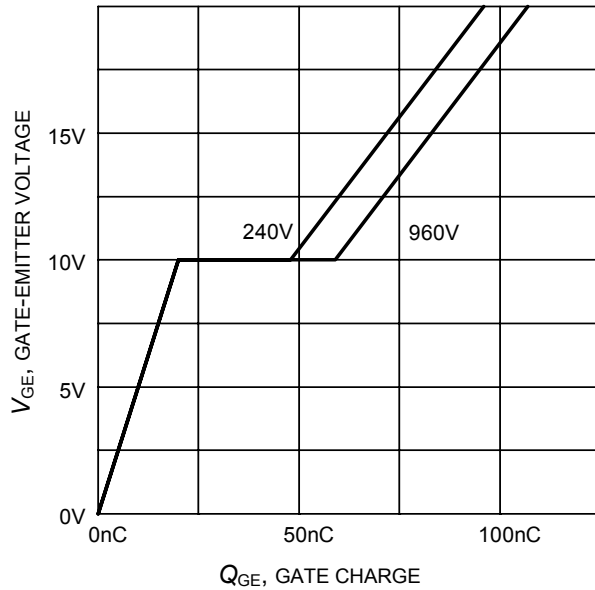
**Figure 14. Typical switching energy losses as a function of gate resistor**  
 (inductive load,  $T_J=150^\circ\text{C}$ ,  $V_{CE}=600\text{V}$ ,  $V_{GE}=0/15\text{V}$ ,  $I_C=15\text{A}$ , Dynamic test circuit in Figure E)



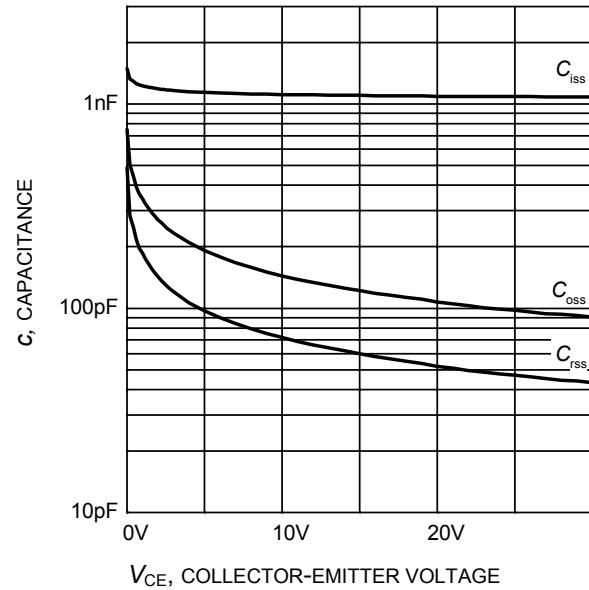
**Figure 15. Typical switching energy losses as a function of junction temperature**  
 (inductive load,  $V_{CE}=600\text{V}$ ,  $V_{GE}=0/15\text{V}$ ,  $I_C=15\text{A}$ ,  $R_G=56\Omega$ , Dynamic test circuit in Figure E)



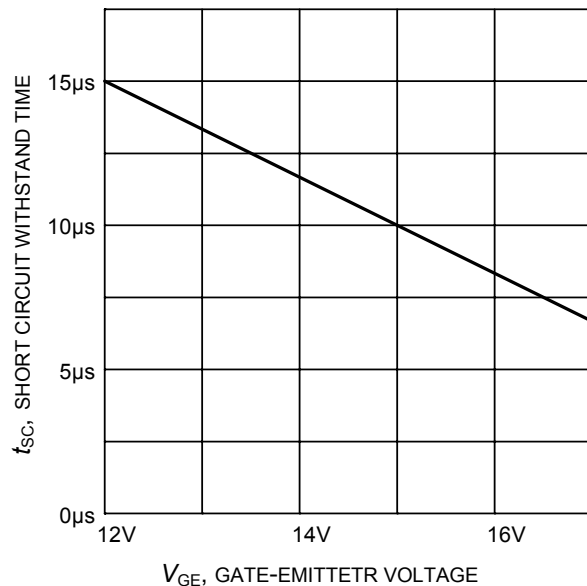
**Figure 16. Typical switching energy losses as a function of collector emitter voltage**  
 (inductive load,  $T_J=150^\circ\text{C}$ ,  $V_{GE}=0/15\text{V}$ ,  $I_C=15\text{A}$ ,  $R_G=56\Omega$ , Dynamic test circuit in Figure E)



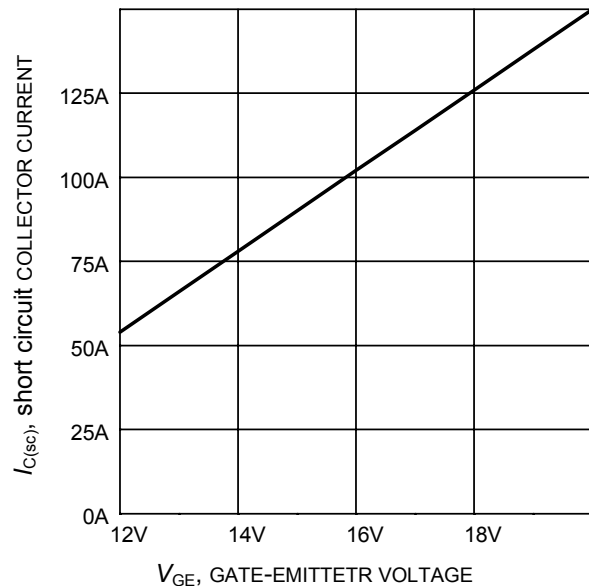
**Figure 17. Typical gate charge**  
( $I_C=15\text{ A}$ )



**Figure 18. Typical capacitance as a function of collector-emitter voltage**  
( $V_{GE}=0\text{V}$ ,  $f = 1\text{ MHz}$ )

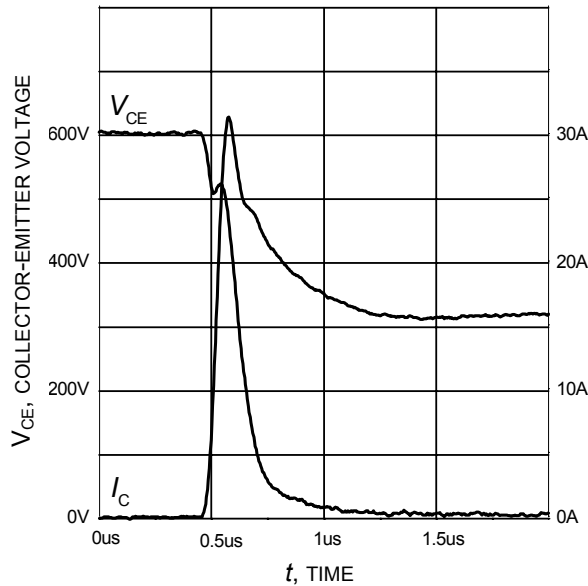


**Figure 19. Short circuit withstand time as a function of gate-emitter voltage**  
( $V_{CE}=600\text{V}$ , start at  $T_J=25^\circ\text{C}$ )

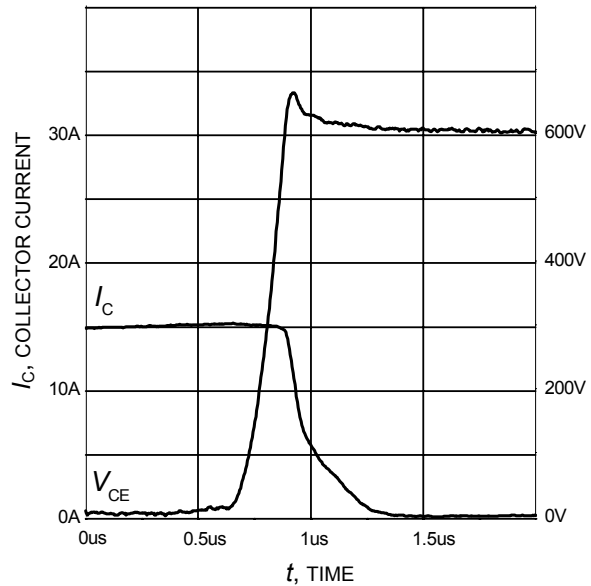


**Figure 20. Typical short circuit collector current as a function of gate-emitter voltage**  
( $V_{CE} \leq 600\text{V}$ ,  $T_J \leq 150^\circ\text{C}$ )

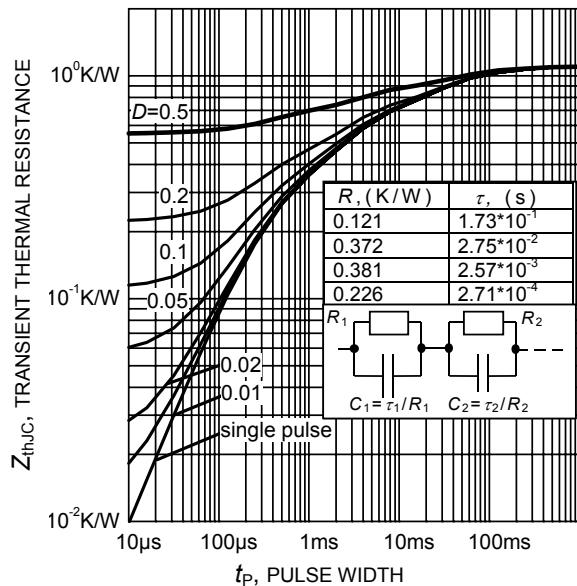




**Figure 21. Typical turn on behavior**  
 $(V_{GE}=0/15V, R_G=56\Omega, T_j = 150^\circ C,$   
 Dynamic test circuit in Figure E)

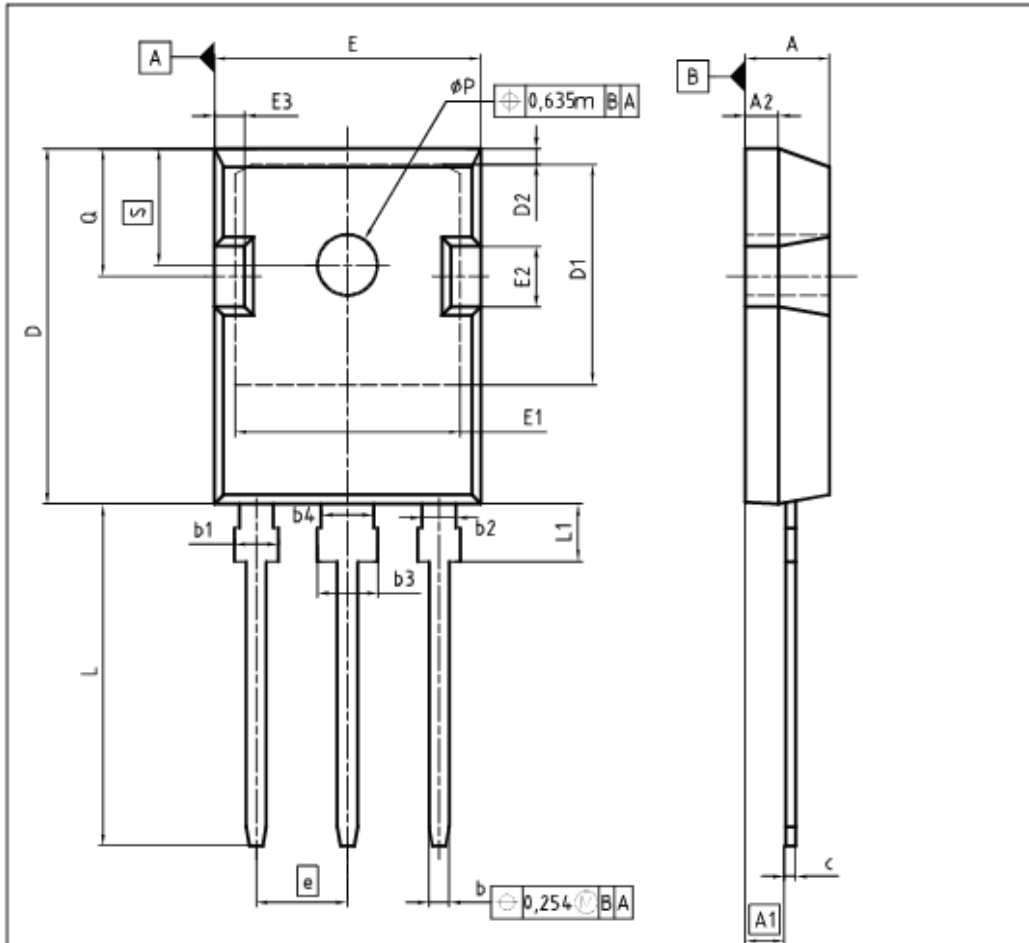


**Figure 22. Typical turn off behavior**  
 $(V_{GE}=15/0V, R_G=56\Omega, T_j = 150^\circ C,$   
 Dynamic test circuit in Figure E)



**Figure 23. IGBT transient thermal resistance**  
 $(D = t_p / T)$

T0247-3



| DIM | MILLIMETERS |       | INCHES |       |
|-----|-------------|-------|--------|-------|
|     | MIN         | MAX   | MIN    | MAX   |
| A   | 4.83        | 5.21  | 0.180  | 0.205 |
| A1  | 2.27        | 2.54  | 0.089  | 0.100 |
| A2  | 1.85        | 2.16  | 0.073  | 0.085 |
| b   | 1.07        | 1.33  | 0.042  | 0.052 |
| b1  | 1.90        | 2.41  | 0.075  | 0.095 |
| b2  | 1.90        | 2.16  | 0.075  | 0.085 |
| b3  | 2.87        | 3.38  | 0.113  | 0.133 |
| b4  | 2.87        | 3.13  | 0.113  | 0.123 |
| c   | 0.55        | 0.68  | 0.022  | 0.027 |
| D   | 20.80       | 21.10 | 0.819  | 0.831 |
| D1  | 16.25       | 17.65 | 0.640  | 0.695 |
| D2  | 0.95        | 1.35  | 0.037  | 0.053 |
| E   | 15.70       | 16.13 | 0.618  | 0.635 |
| E1  | 13.10       | 14.15 | 0.516  | 0.557 |
| E2  | 3.68        | 5.10  | 0.145  | 0.201 |
| E3  | 1.00        | 2.60  | 0.039  | 0.102 |
| e   | 5.44        |       | 0.214  |       |
| N   | 3           |       | 3      |       |
| L   | 19.80       | 20.32 | 0.780  | 0.800 |
| L1  | 4.10        | 4.47  | 0.161  | 0.176 |
| φP  | 3.50        | 3.70  | 0.138  | 0.146 |
| Q   | 5.49        | 6.00  | 0.216  | 0.236 |
| S   | 6.04        | 6.30  | 0.238  | 0.248 |

DOCUMENT NO.  
Z8B00003327

SCALE

EUROPEAN PROJECTION

ISSUE DATE  
01-10-2009

REVISION  
04

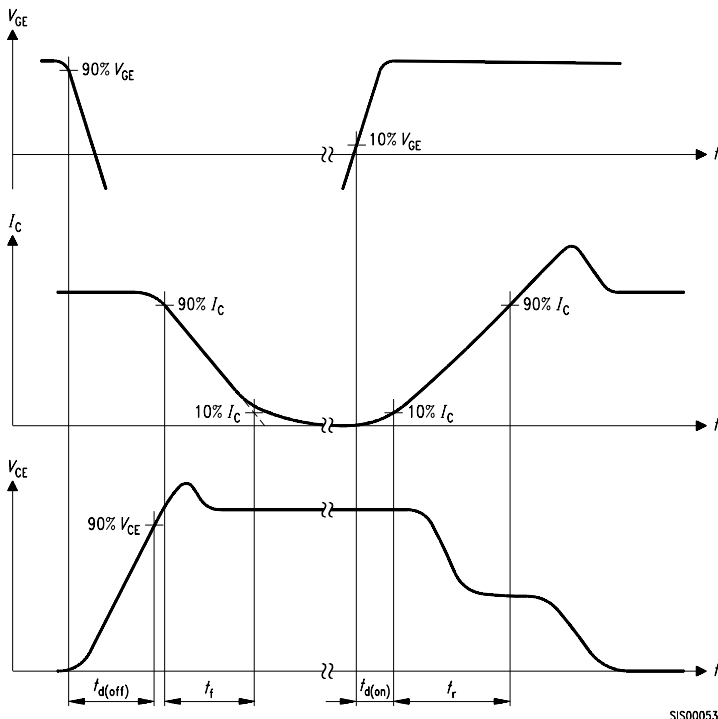


Figure A. Definition of switching times

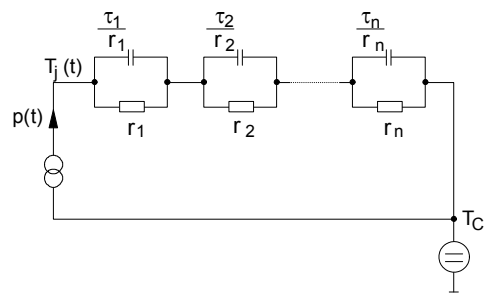


Figure D. Thermal equivalent circuit

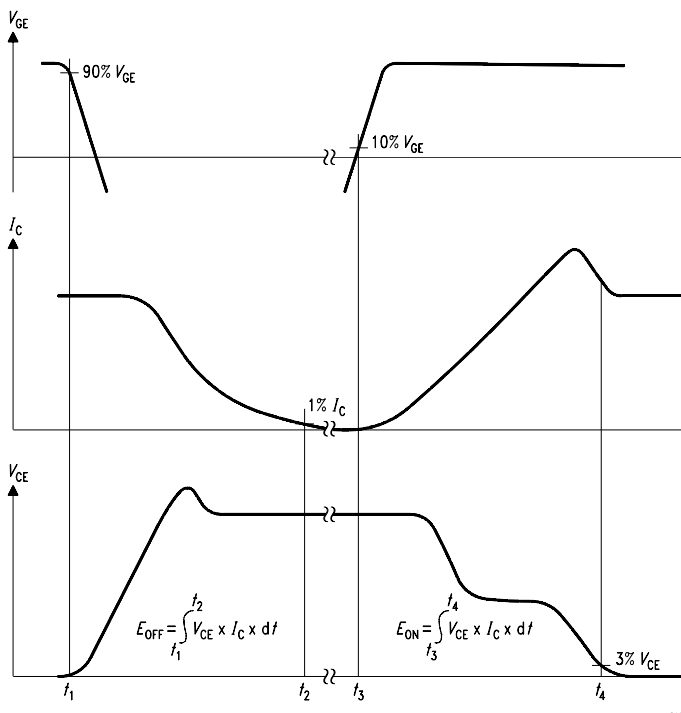


Figure B. Definition of switching losses

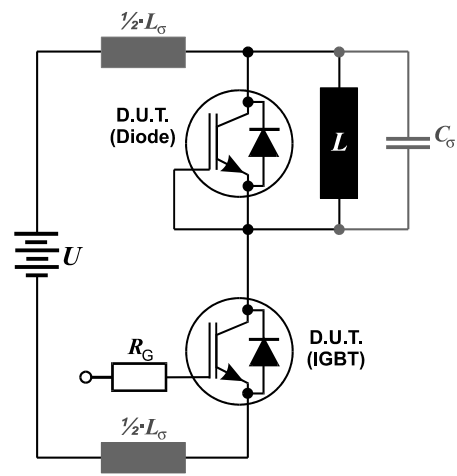


Figure E. Dynamic test circuit  
Leakage inductance  $L_\sigma = 180\text{nH}$   
and Stray capacity  $C_\sigma = 39\text{pF}$ .

**Edition 2006-01**

**Published by  
Infineon Technologies AG  
81726 München, Germany**

**© Infineon Technologies AG 11/18/09.  
All Rights Reserved.**

**Attention please!**

The information given in this data sheet shall in no event be regarded as a guarantee of conditions or characteristics ("Beschaffenheitsgarantie"). With respect to any examples or hints given herein, any typical values stated herein and/or any information regarding the application of the device, Infineon Technologies hereby disclaims any and all warranties and liabilities of any kind, including without limitation warranties of non-infringement of intellectual property rights of any third party.

**Information**

For further information on technology, delivery terms and conditions and prices please contact your nearest Infineon Technologies Office ([www.infineon.com](http://www.infineon.com)).

**Warnings**

Due to technical requirements components may contain dangerous substances. For information on the types in question please contact your nearest Infineon Technologies Office.

Infineon Technologies Components may only be used in life-support devices or systems with the express written approval of Infineon Technologies, if a failure of such components can reasonably be expected to cause the failure of that life-support device or system, or to affect the safety or effectiveness of that device or system. Life support devices or systems are intended to be implanted in the human body, or to support and/or maintain and sustain and/or protect human life. If they fail, it is reasonable to assume that the health of the user or other persons may be endangered.