

Fuji Discrete Package IGBT

■ Features

- Square RBSOA
- Low Saturation Voltage
- Less Total Power Dissipation
- Minimized Internal Stray Inductance

■ Applications

- High Power Switching
- A.C. Motor Controls
- D.C. Motor Controls
- Uninterruptible Power Supply

■ Outline Drawing

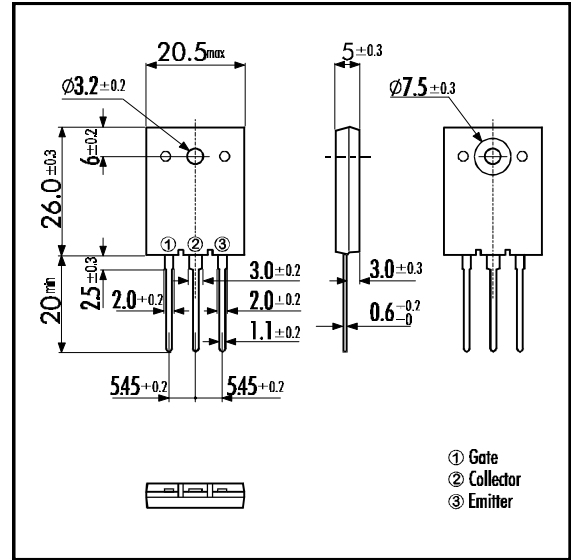

■ Maximum Ratings and Characteristics

• Absolute Maximum Ratings ($T_c=25^\circ\text{C}$)

Items	Symbols	Ratings	Units
Collector-Emitter Voltage	V_{CES}	1200	V
Gate -Emitter Voltage	V_{GES}	± 20	V
Collector Current	DC $T_c=25^\circ\text{C}$	I_{C25}	38
	DC $T_c=100^\circ\text{C}$	I_{C100}	25
	1ms $T_c=25^\circ\text{C}$	I_{CPULSE}	114
IGBT Max. Power Dissipation	P_C	310	W
Operating Temperature	T_j	+150	$^\circ\text{C}$
Storage Temperature	T_{stg}	-40 ~ +150	$^\circ\text{C}$
Mounting Screw Torque		70	Nm

■ Equivalent Circuit

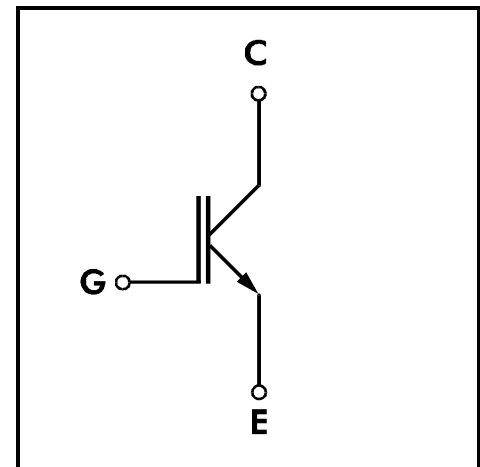

• Electrical Characteristics (at $T_f=25^\circ\text{C}$)

Items	Symbols	Test Conditions	Min.	Typ.	Max.	Units	
Zero Gate Voltage Collector Current	I_{CES}	$V_{GE}=0V$ $V_{CE}=1200V$			1.0	mA	
Gate-Emitter Leakage Current	I_{GES}	$V_{CE}=0V$ $V_{GE}=\pm 20V$			20	μA	
Gate-Emitter Threshold Voltage	$V_{GE(th)}$	$V_{GE}=20V$ $I_C=25\text{mA}$	5.5		8.5	V	
Collector-Emitter Saturation Voltage	$V_{CE(sat)}$	$V_{GE}=15V$ $I_C=25\text{A}$			3.5	V	
Input capacitance	C_{ies}	$V_{GE}=0V$		2500		pF	
Output capacitance	C_{oes}	$V_{CE}=10V$		500			
Reverse Transfer capacitance	C_{res}	$f=1\text{MHz}$		200			
Switching Time	Turn-on Time	t_{ON}	$V_{CC}=600V$ $I_C=25A$ $V_{GE}=\pm 15V$ $R_G=82\Omega$		1.2	μs	
		t_r			0.6		
	Turn-off Time	t_{OFF}			1.5		
		t_f			0.5		
	Turn-on Time	t_{ON}	$V_{CC}=600V$ $I_C=25A$ $V_{GE}=+15V$ $R_G=8\Omega$		0.16	μs	
		t_r			0.11		
		Turn-off Time		t_{OFF}			0.30
				t_f			0.5

• Thermal Characteristics

Items	Symbols	Test Conditions	Min.	Typ.	Max.	Units
Thermal Resistance	$R_{th(i-c)}$	IGBT			0.40	$^\circ\text{C/W}$

Collector Current vs. Collector-Emittor Voltage

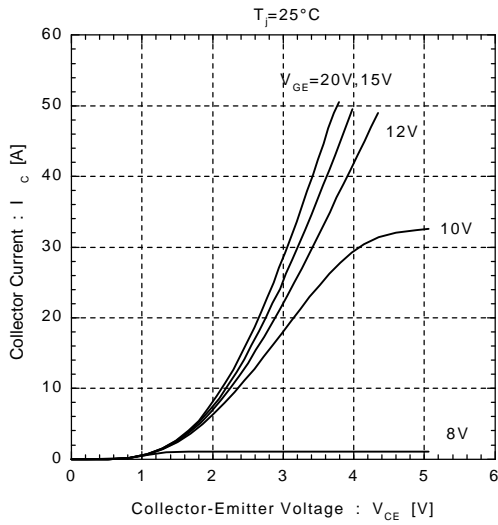

Collector Current vs. Collector-Emittor Voltage

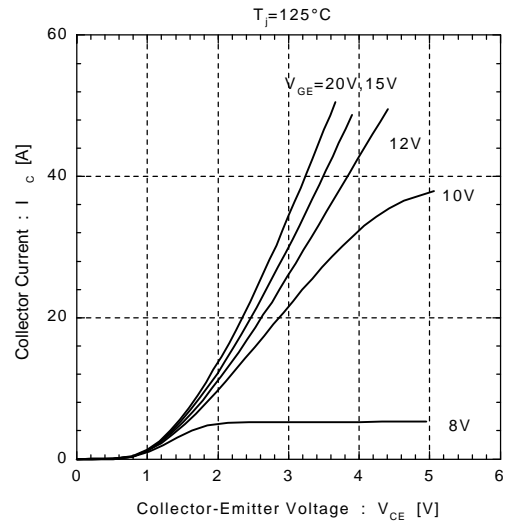

Collector-Emittor Voltage vs. Gate-Emittor Voltage

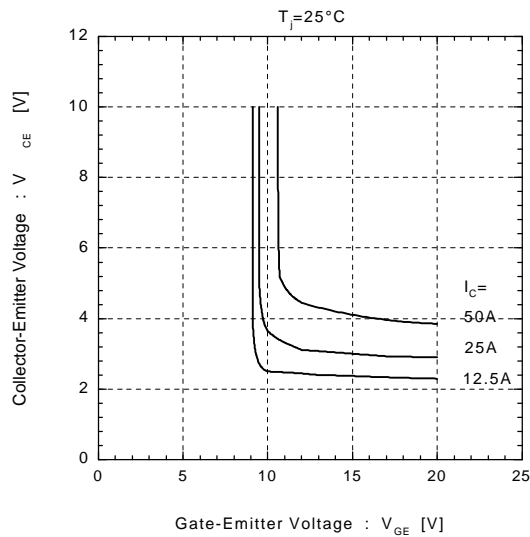

Collector-Emittor Voltage vs. Gate-Emittor Voltage

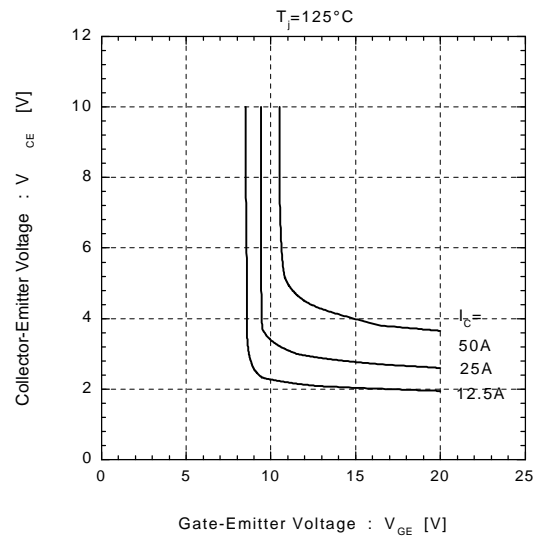

Switching Time vs. Collector Current

$V_{CC}=600V, R_G=8.2\Omega, V_{GE}=\pm 15V, T_J=25^\circ\text{C}$

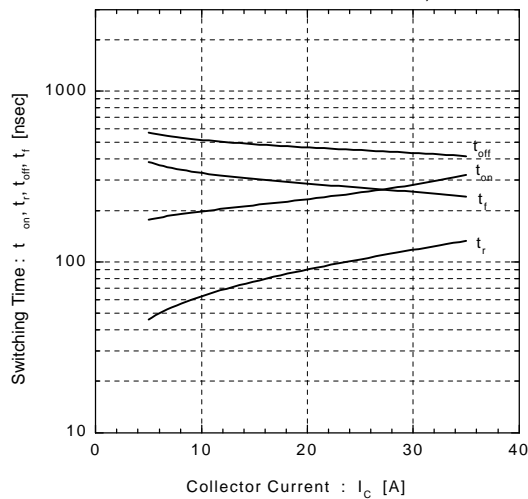

Switching Time vs. Collector Current

$V_{CC}=600V, R_G=8.2\Omega, V_{GE}=\pm 15V, T_J=125^\circ\text{C}$

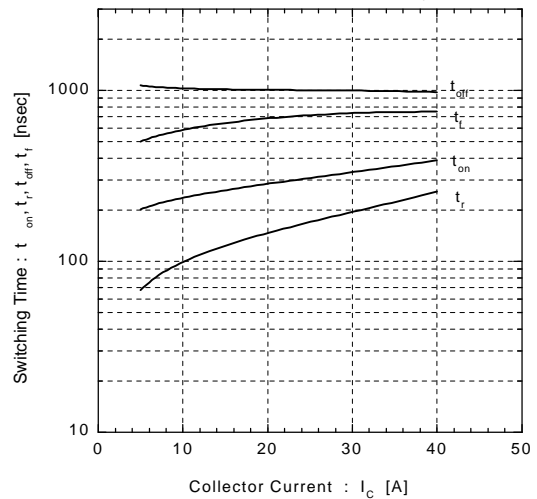

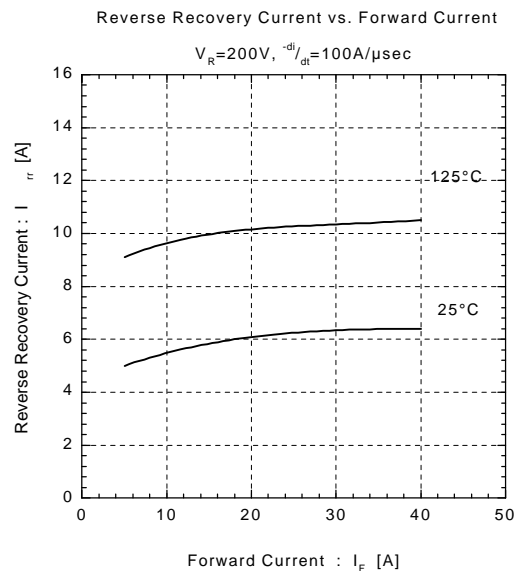
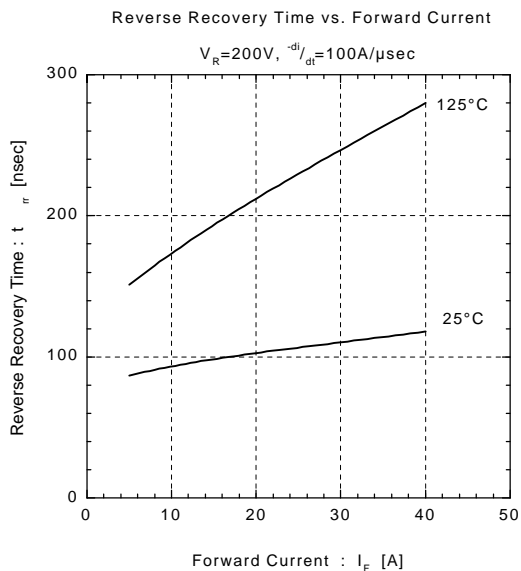
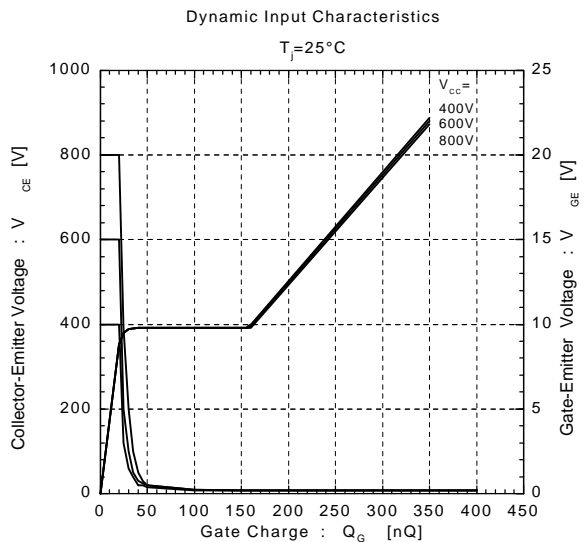
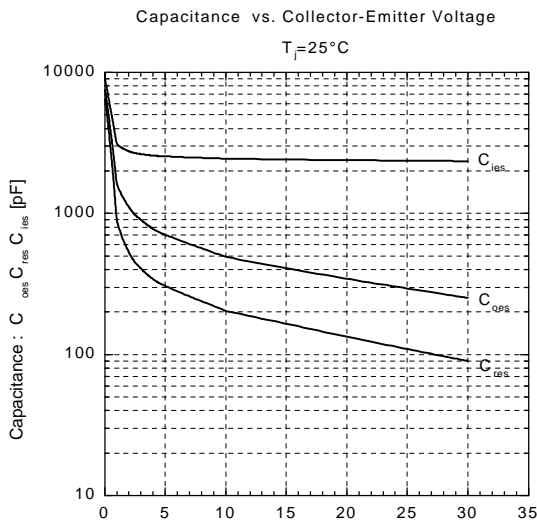
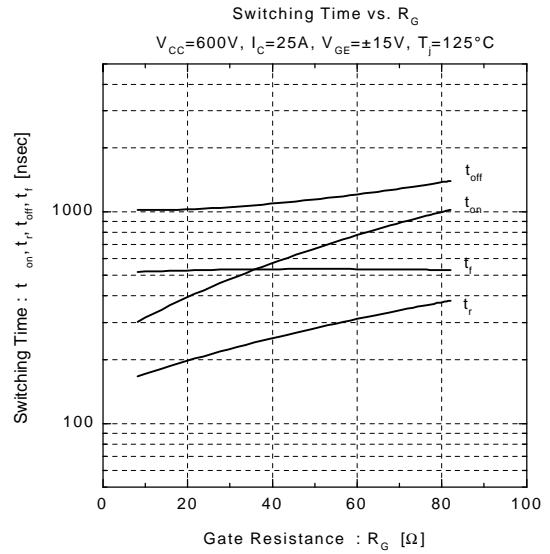
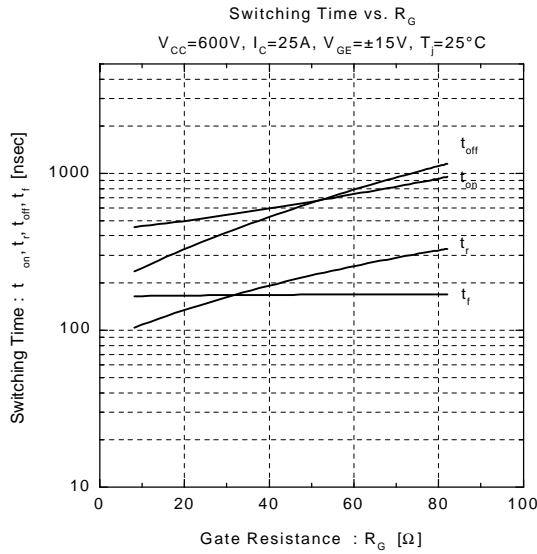

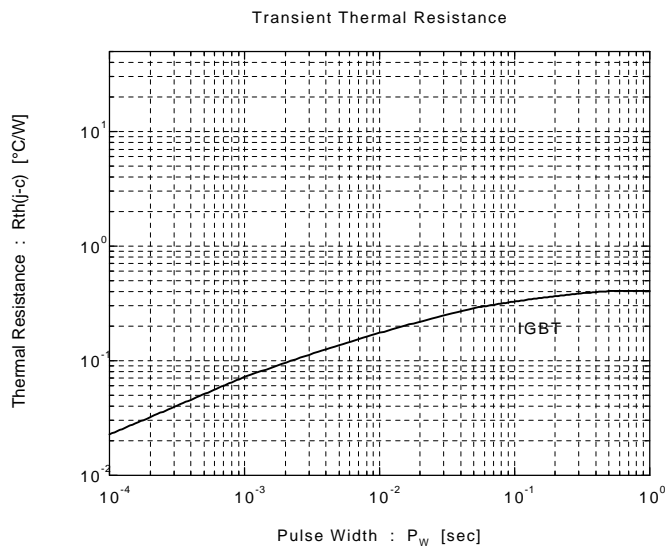
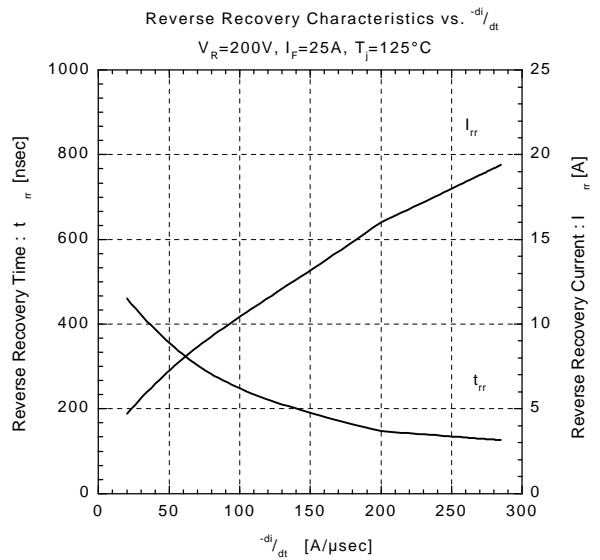
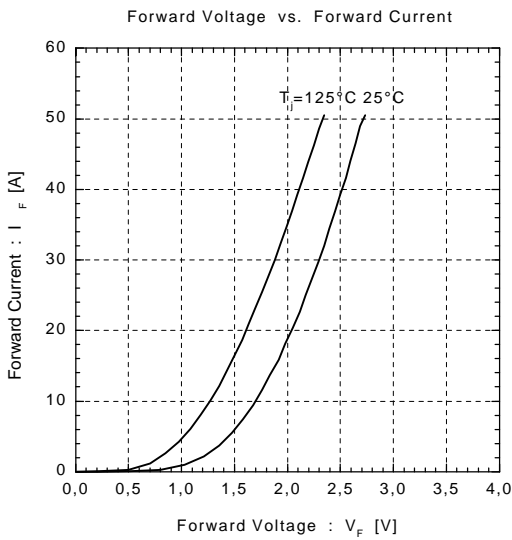
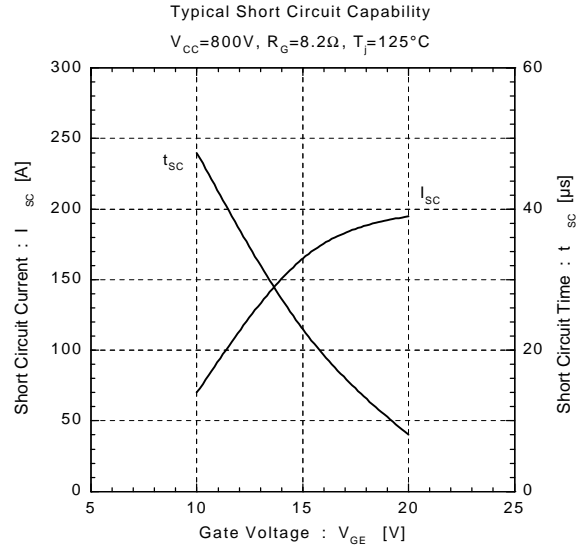
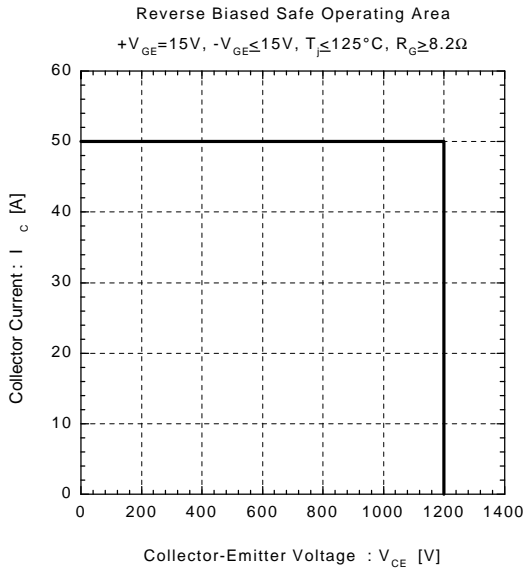

This datasheet has been download from:

www.datasheetcatalog.com

Datasheets for electronics components.