

## Fuji Discrete Package IGBT

### ■ Features

- Square RBSOA
- Low Saturation Voltage
- Less Total Power Dissipation
- Minimized Internal Stray Inductance

### ■ Applications

- High Power Switching
- A.C. Motor Controls
- D.C. Motor Controls
- Uninterruptible Power Supply

## ■ Outline Drawing

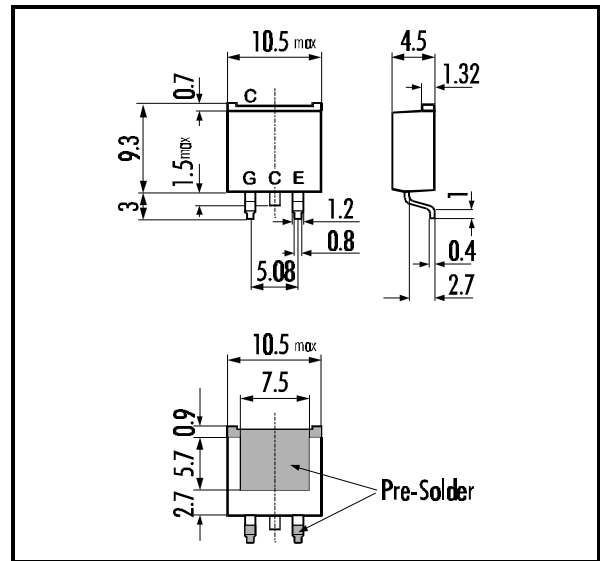

## ■ Maximum Ratings and Characteristics

### • Absolute Maximum Ratings (T<sub>c</sub>=25°C)

Items	Symbols	Ratings	Units
Collector-Emitter Voltage	V <sub>CEs</sub>	600	V
Gate -Emitter Voltage	V <sub>GES</sub>	± 20	V
Collector Current	DC T <sub>c</sub> = 25°C	I <sub>C 25</sub>	20
	DC T <sub>c</sub> =100°C	I <sub>C 100</sub>	10
	1ms T <sub>c</sub> = 25°C	I <sub>C PULSE</sub>	80
IGBT Max. Power Dissipation	P <sub>C</sub>	75	W
FWD Max. Power Dissipation	P <sub>C</sub>	35	W
Operating Temperature	T <sub>j</sub>	+150	°C
Storage Temperature	T <sub>stg</sub>	-40 ~ +125	°C

## ■ Equivalent Circuit

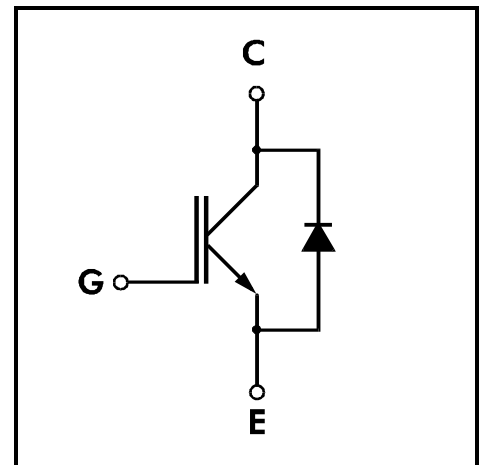

### • Electrical Characteristics (at T<sub>F</sub>=25°C)

Items	Symbols	Test Conditions	Min.	Typ.	Max.	Units	
Zero Gate Voltage Collector Current	I <sub>CEs</sub>	V <sub>GE</sub> =0V V <sub>CE</sub> =600V			1.0	mA	
Gate-Emitter Leakage Current	I <sub>GES</sub>	V <sub>CE</sub> =0V V <sub>GE</sub> =± 20V			20	μA	
Gate-Emitter Threshold Voltage	V <sub>GE(th)</sub>	V <sub>GE</sub> =20V I <sub>C</sub> =10mA	5.5		8.5	V	
Collector-Emitter Saturation Voltage	V <sub>CE(sat)</sub>	V <sub>GE</sub> =15V I <sub>C</sub> =10A			3.0		
Input capacitance	C <sub>ies</sub>	V <sub>GE</sub> =0V		700		pF	
Output capacitance	C <sub>oes</sub>	V <sub>CE</sub> =10V		150			
Reverse Transfer capacitance	C <sub>res</sub>	f=1MHz		20			
Switching Time	Turn-on Time	t <sub>ON</sub>	V <sub>CC</sub> =300V			1.2	μs
		t <sub>r</sub>	I <sub>C</sub> =10A			0.6	
	Turn-off Time	t <sub>OFF</sub>	V <sub>GE</sub> =±15V			1.0	
		t <sub>f</sub>	R <sub>G</sub> =220Ω			0.35	
	Turn-on Time	t <sub>ON</sub>	V <sub>CC</sub> =300V		0.16		μs
		t <sub>r</sub>	I <sub>C</sub> =10A		0.11		
		t <sub>OFF</sub>	V <sub>GE</sub> =+15V		0.30		
		t <sub>f</sub>	R <sub>G</sub> =22Ω			0.35	
Diode Forward On-Voltage	V <sub>F</sub>	I <sub>F</sub> =10A V <sub>GE</sub> =0V			3.0	V	
Reverse Recovery Time	t <sub>rr</sub>	I <sub>F</sub> =10A, V <sub>GE</sub> =-10V, di/dt=100A/μs			300	ns	

### • Thermal Characteristics

Items	Symbols	Test Conditions	Min.	Typ.	Max.	Units
Thermal Resistance	R <sub>th(j-c)</sub>	IGBT			1.66	°C/W
	R <sub>th(j-e)</sub>	Diode			3.57	

Collector Current vs. Collector-Emittor Voltage

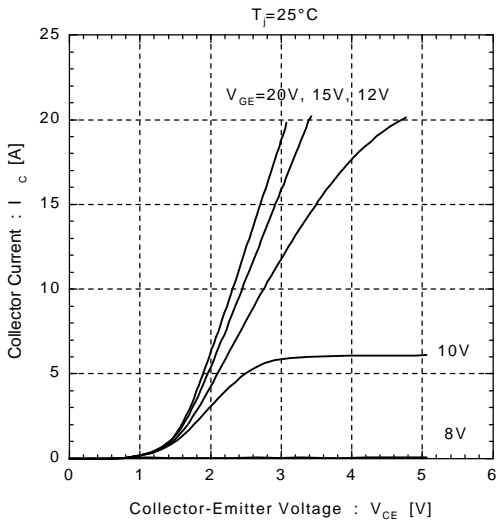

Collector Current vs. Collector-Emittor Voltage

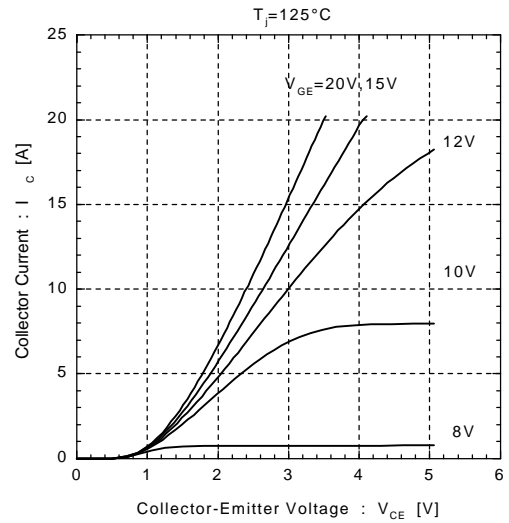

Collector-Emittor Voltage vs. Gate-Emittor Voltage

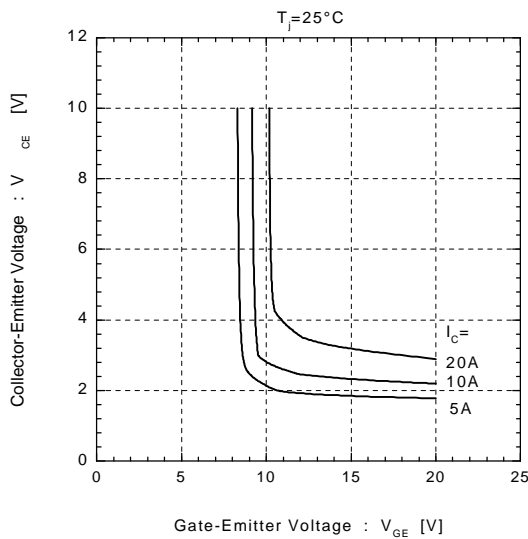

Collector-Emittor Voltage vs. Gate-Emittor Voltage

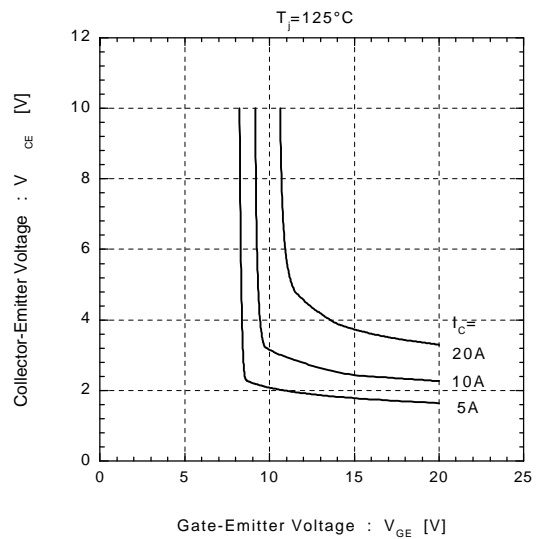

Switching Time vs. Collector Current

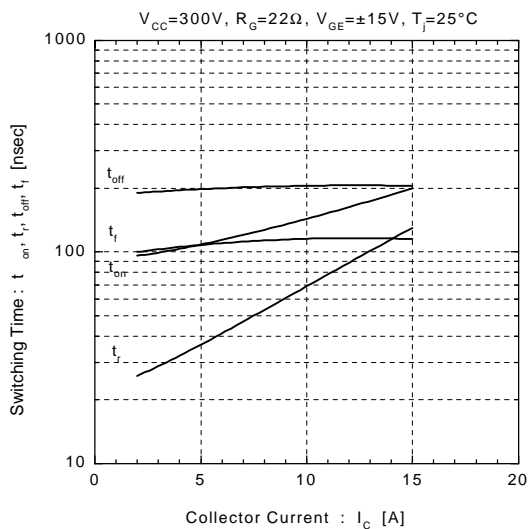

Switching Time vs. Collector Current

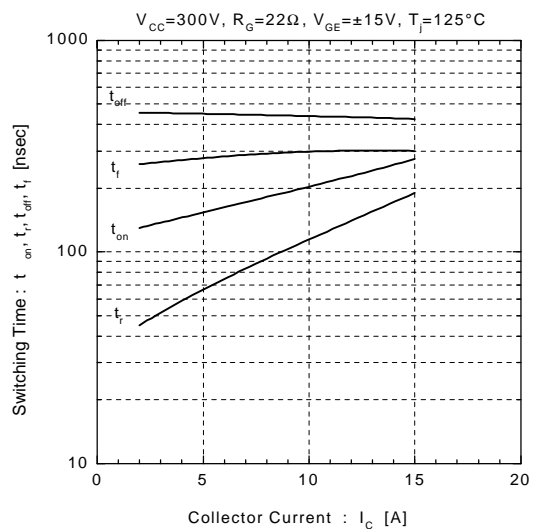

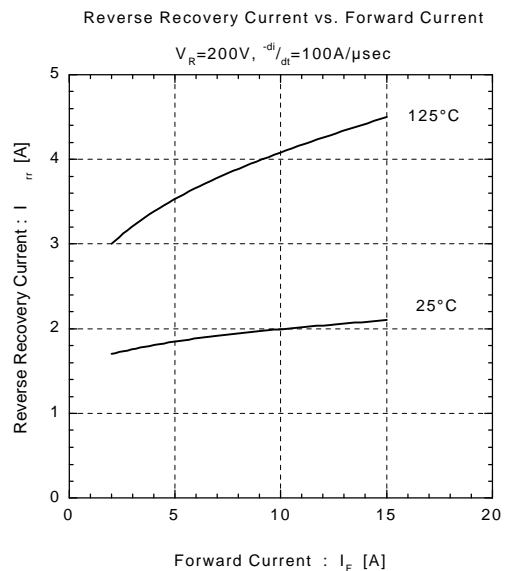
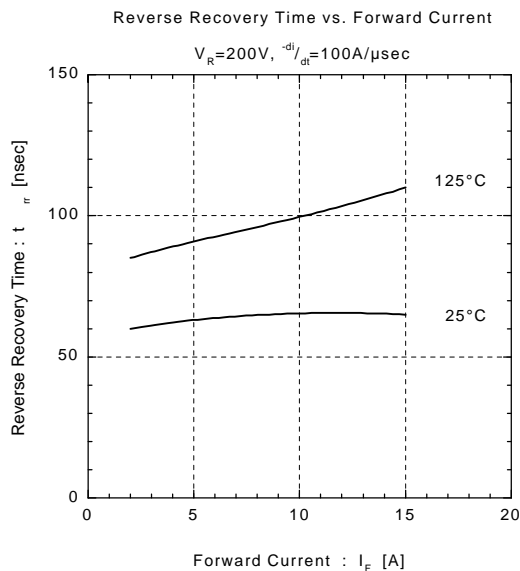
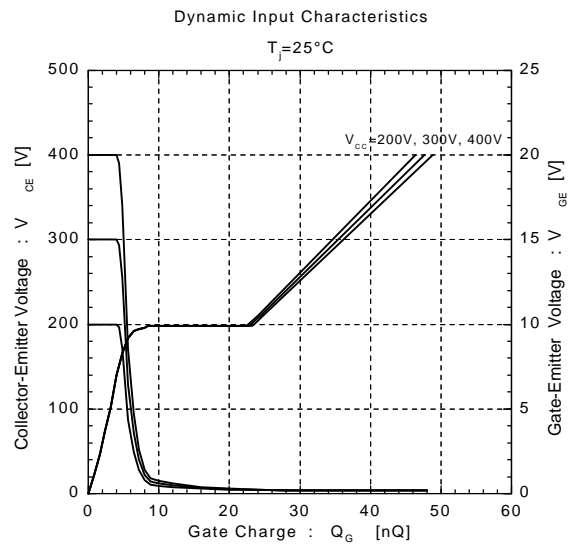
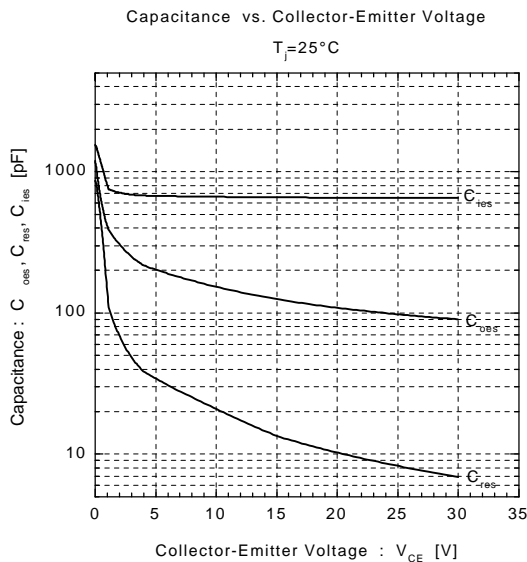
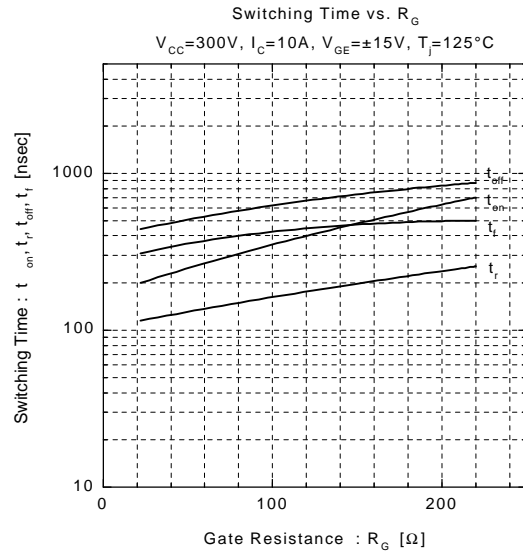
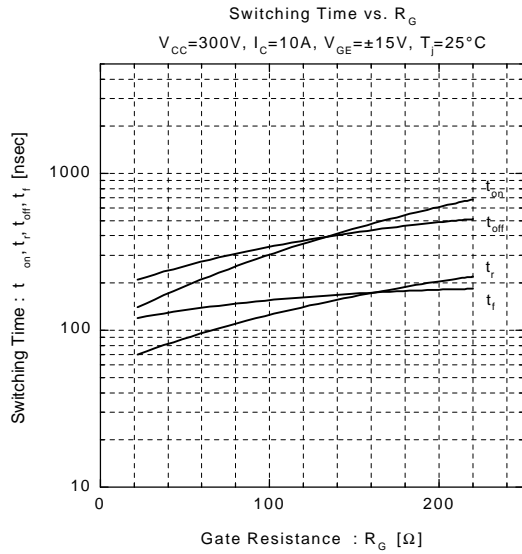

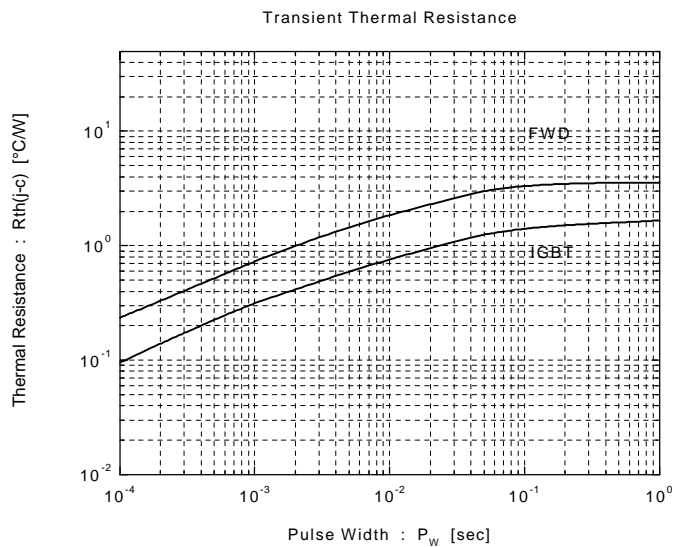
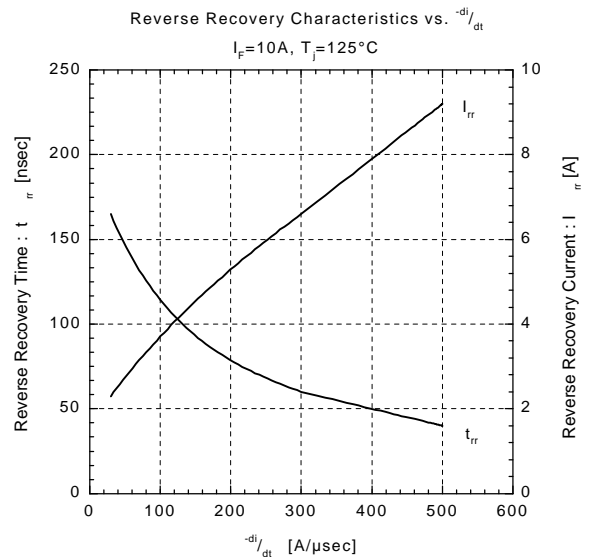
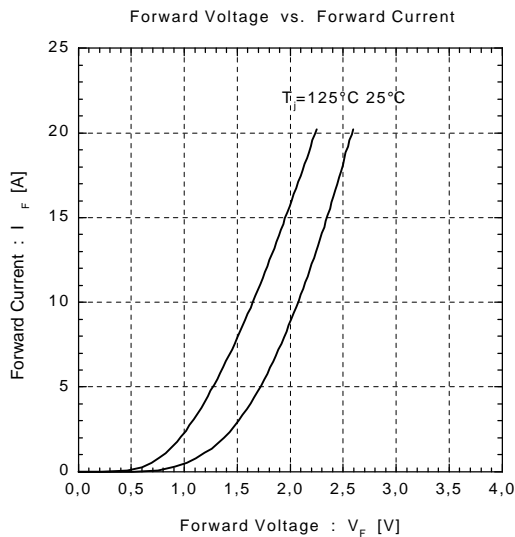
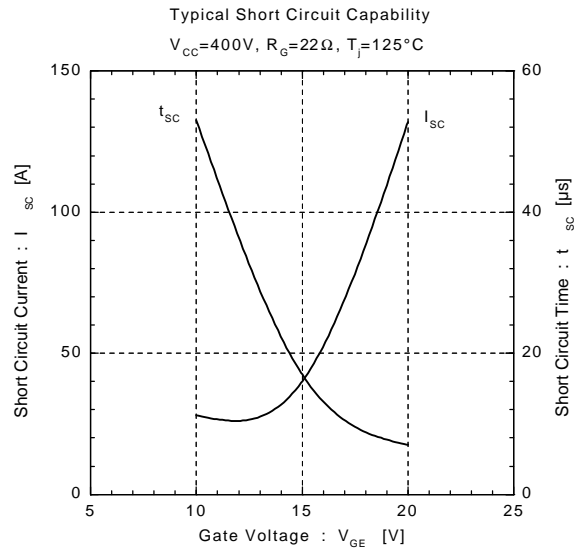
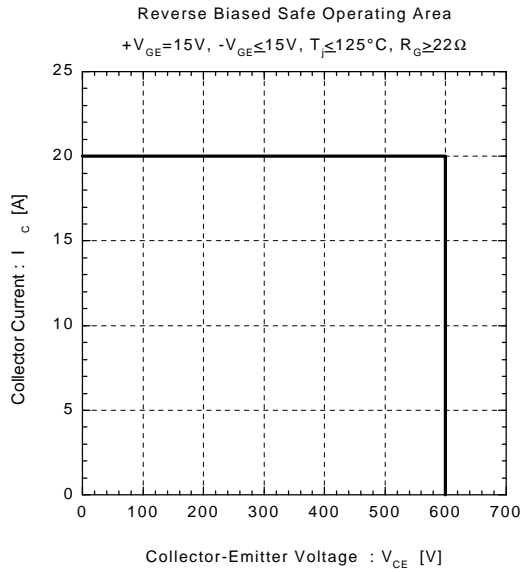

This datasheet has been download from:

[www.datasheetcatalog.com](http://www.datasheetcatalog.com)

Datasheets for electronics components.