

Fuji Discrete Package IGBT

■ Features

- Square RBSOA
- Low Saturation Voltage
- Less Total Power Dissipation
- Minimized Internal Stray Inductance

■ Applications

- High Power Switching
- A.C. Motor Controls
- D.C. Motor Controls
- Uninterruptible Power Supply

■ Outline Drawing

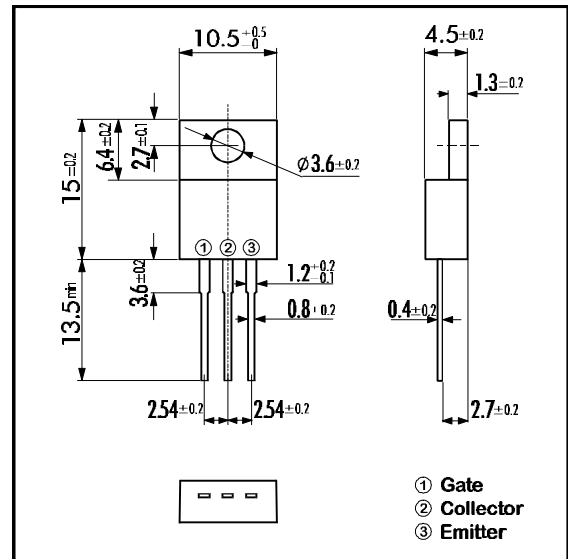

■ Maximum Ratings and Characteristics

• Absolute Maximum Ratings (T_c=25°C)

Items	Symbols	Ratings	Units
Collector-Emitter Voltage	V _{CEs}	600	V
Gate -Emitter Voltage	V _{GES}	± 20	V
Collector Current	DC T _c = 25°C	I _{C 25}	20
	DC T _c =100°C	I _{C 100}	10
	1ms T _c = 25°C	I _{C PULSE}	80
IGBT Max. Power Dissipation	P _C	75	W
Operating Temperature	T _j	+150	°C
Storage Temperature	T _{stg}	-40 ~ +125	°C
Mounting Screw Torque		40	Nm

■ Equivalent Circuit

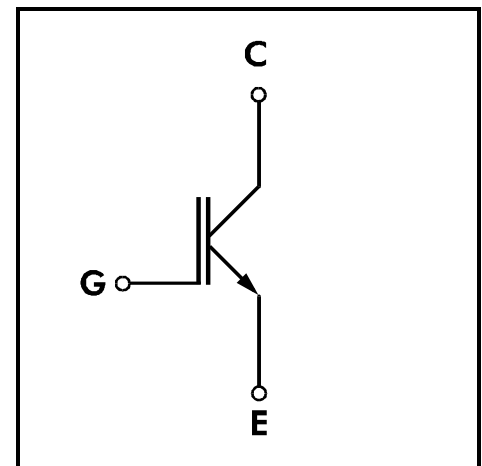

• Electrical Characteristics (at T_j=25°C)

Items	Symbols	Test Conditions	Min.	Typ.	Max.	Units	
Zero Gate Voltage Collector Current	I _{CEs}	V _{GE} =0V V _{CE} =600V			1.0	mA	
Gate-Emitter Leakage Current	I _{GES}	V _{CE} =0V V _{GE} =± 20V			20	μA	
Gate-Emitter Threshold Voltage	V _{GE(th)}	V _{GE} =20V I _C =10mA	5.5		8.5	V	
Collector-Emitter Saturation Voltage	V _{CE(sat)}	V _{GE} =15V I _C =10A			3.0	V	
Input capacitance	C _{ies}	V _{GE} =0V		700		pF	
Output capacitance	C _{oes}	V _{CE} =10V		150			
Reverse Transfer capacitance	C _{res}	f=1MHz		20			
Switching Time	Turn-on Time	t _{ON}	V _{CC} =300V			1.2	μs
		t _r	I _C =10A			0.6	
	Turn-off Time	t _{OFF}	V _{GE} =±15V			1.0	
		t _f	R _G =220Ω			0.35	
	Turn-on Time	t _{ON}	V _{CC} =300V		0.16		μs
		t _r	I _C =10A		0.11		
t _{OFF}		V _{GE} =+15V		0.30			
t _f		R _G =22Ω			0.35		

• Thermal Characteristics

Items	Symbols	Test Conditions	Min.	Typ.	Max.	Units
Thermal Resistance	R _{th(j-c)}				1.66	°C/W

Collector Current vs. Collector-Emittter Voltage

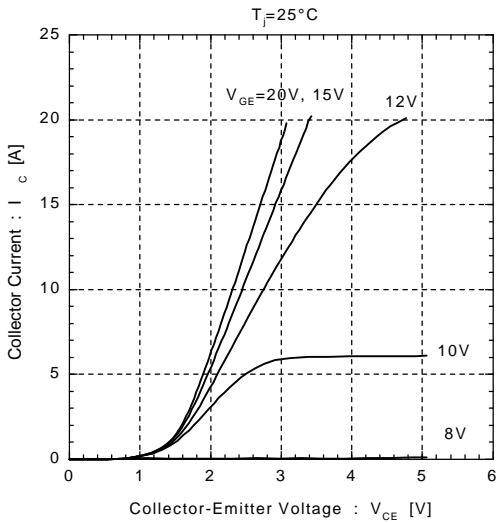

Collector Current vs. Collector-Emittter Voltage

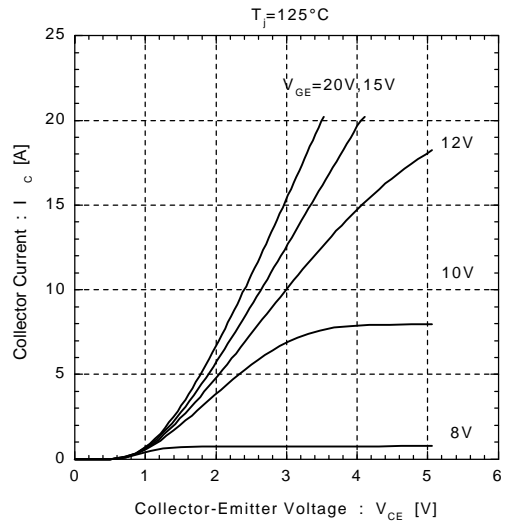

Collector-Emittter Voltage vs. Gate-Emittter Voltage

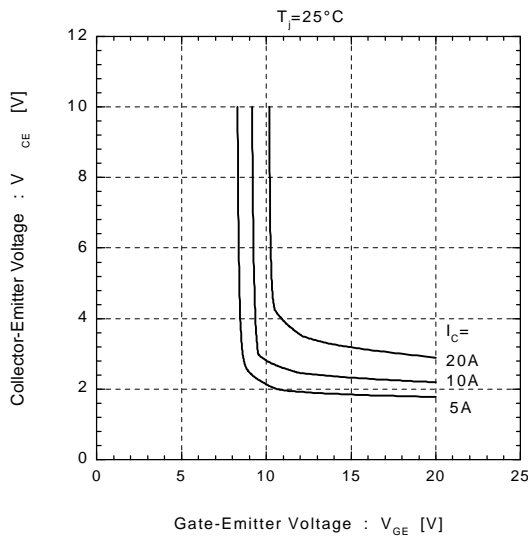

Collector-Emittter Voltage vs. Gate-Emittter Voltage

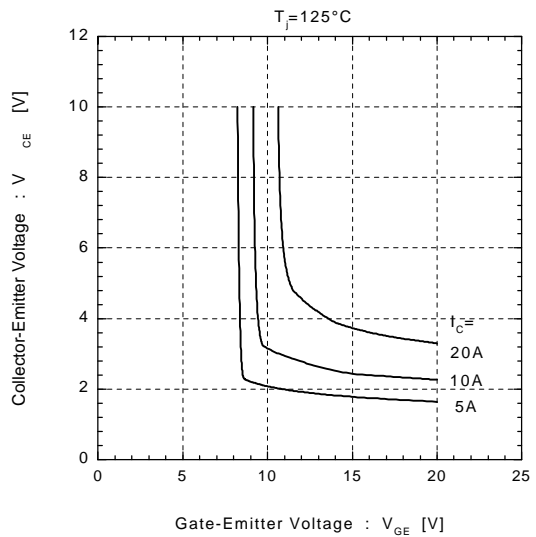

Switching Time vs. Collector Current
 $V_{cc}=300\text{V}, R_g=22\Omega, V_{ge}=\pm 15\text{V}, T_J=25^\circ\text{C}$

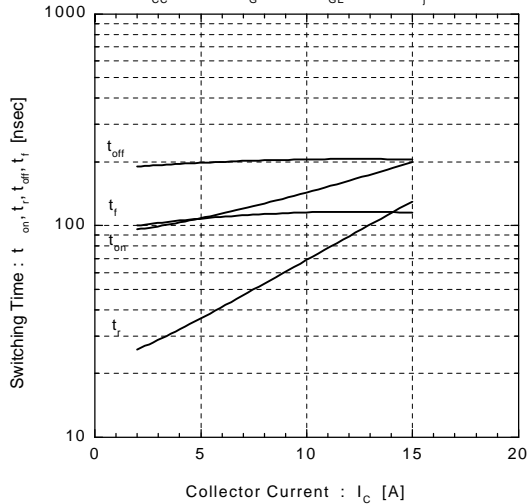

Switching Time vs. Collector Current
 $V_{cc}=300\text{V}, R_g=22\Omega, V_{ge}=\pm 15\text{V}, T_J=125^\circ\text{C}$

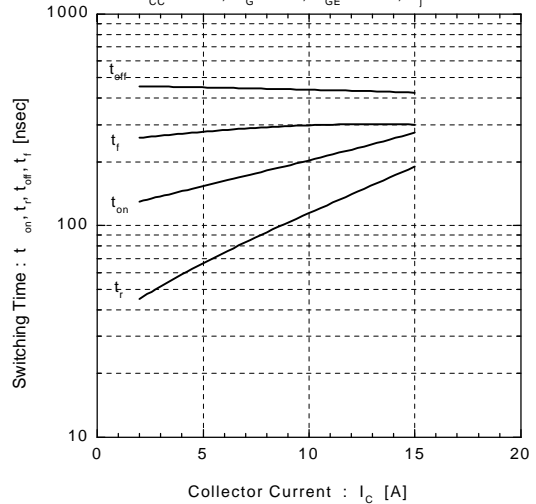

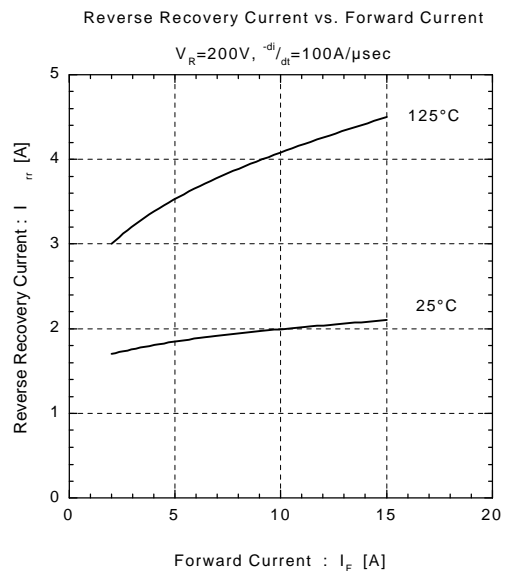
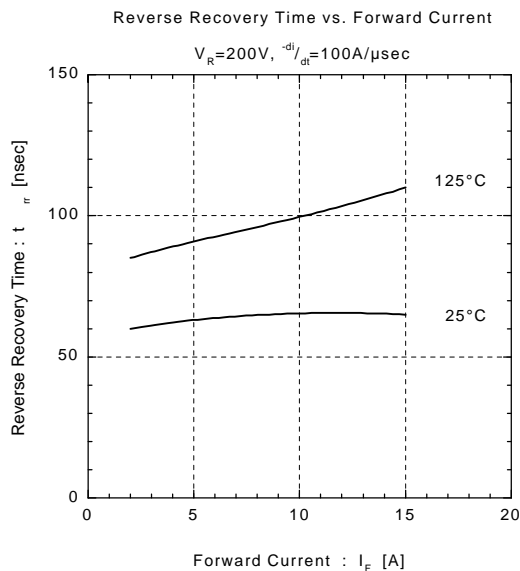
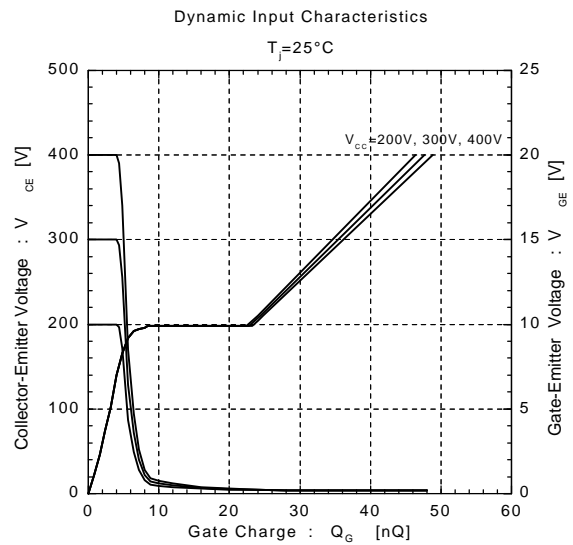
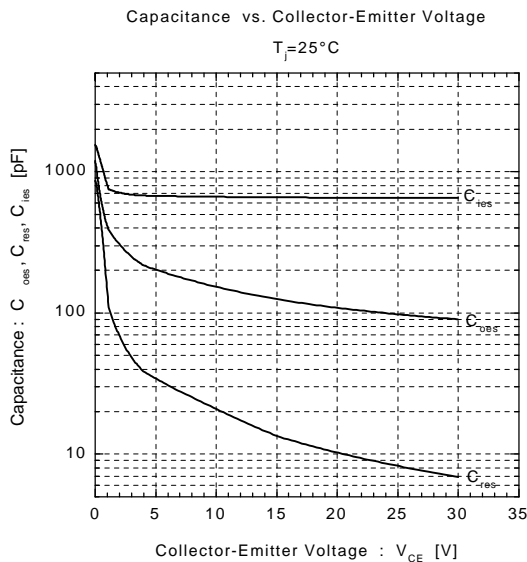
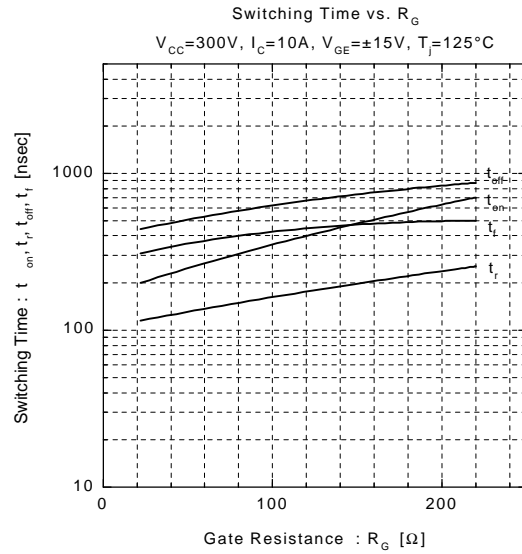
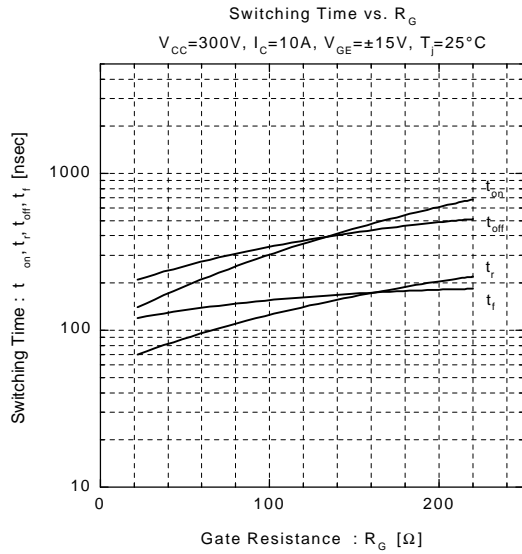

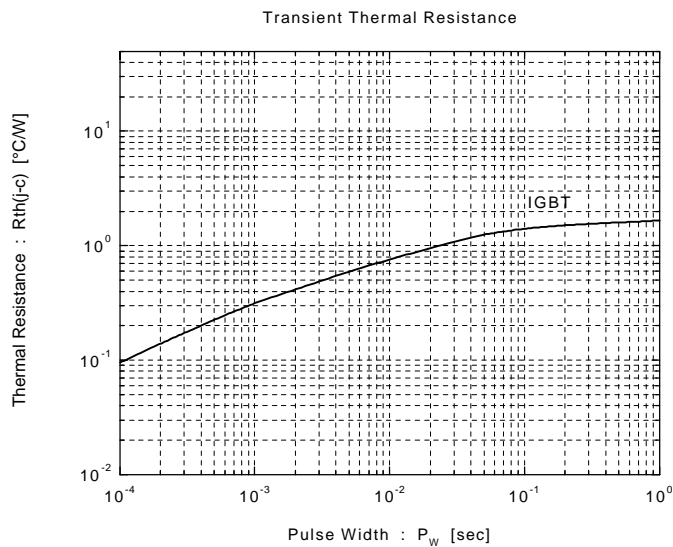
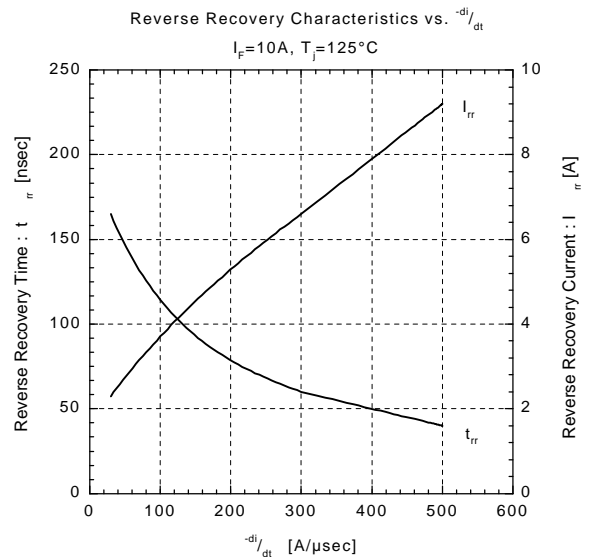
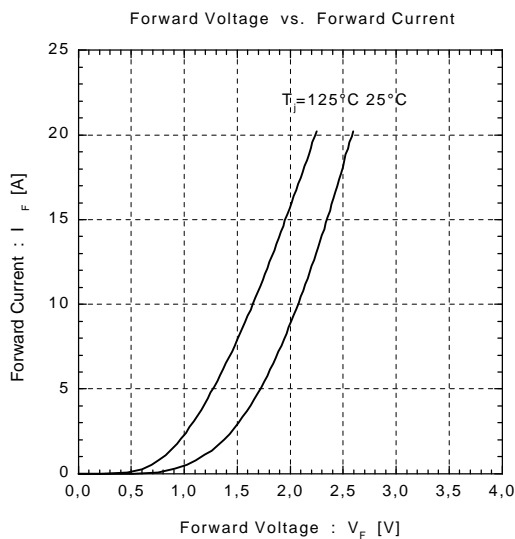
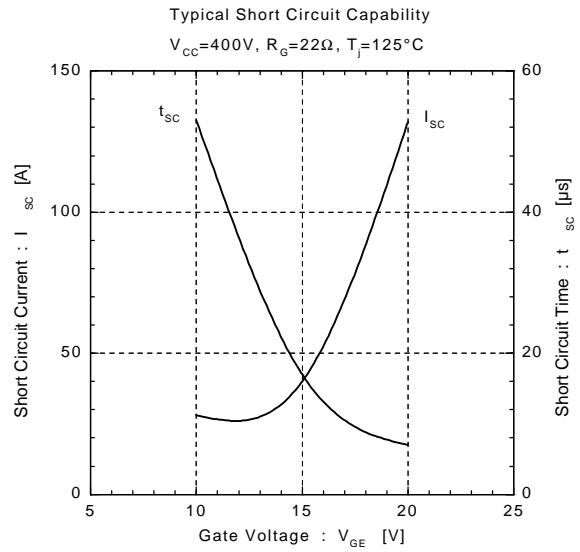
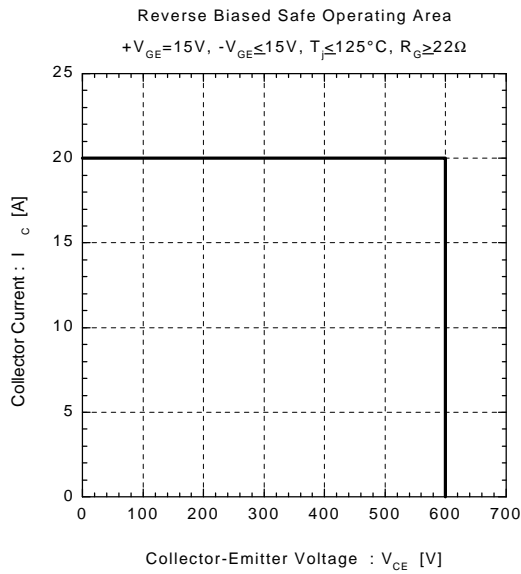

This datasheet has been download from:

www.datasheetcatalog.com

Datasheets for electronics components.