

Fuji Discrete Package IGBT

■ Features

- Square RBSOA
- Low Saturation Voltage
- Less Total Power Dissipation
- Minimized Internal Stray Inductance

■ Applications

- High Power Switching
- A.C. Motor Controls
- D.C. Motor Controls
- Uninterruptible Power Supply

■ Outline Drawing

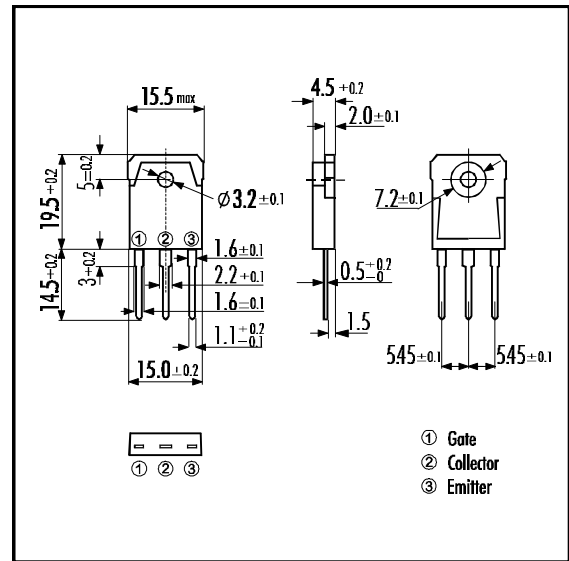

■ Maximum Ratings and Characteristics

• Absolute Maximum Ratings ($T_c=25^\circ\text{C}$)

Items	Symbols	Ratings	Units
Collector-Emitter Voltage	V_{CES}	1200	V
Gate -Emitter Voltage	V_{GES}	± 20	V
Collector Current	DC $T_c=25^\circ\text{C}$	I_{C25}	16
	DC $T_c=100^\circ\text{C}$	I_{C100}	10
	1ms $T_c=25^\circ\text{C}$	I_{CPULSE}	48
IGBT Max. Power Dissipation	P_C	135	W
Operating Temperature	T_j	+150	$^\circ\text{C}$
Storage Temperature	T_{stg}	-40 ~ +150	$^\circ\text{C}$
Mounting Screw Torque		50	Nm

■ Equivalent Circuit

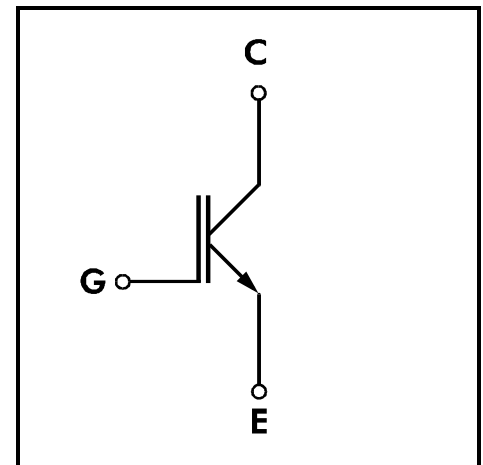

• Electrical Characteristics (at $T_F=25^\circ\text{C}$)

Items	Symbols	Test Conditions	Min.	Typ.	Max.	Units		
Zero Gate Voltage Collector Current	I_{CES}	$V_{GE}=0V$ $V_{CE}=1200V$			1.0	mA		
Gate-Emitter Leakage Current	I_{GES}	$V_{CE}=0V$ $V_{GE}=\pm 20V$			20	μA		
Gate-Emitter Threshold Voltage	$V_{GE(th)}$	$V_{GE}=20V$ $I_C=10\text{mA}$	5.5		8.5	V		
Collector-Emitter Saturation Voltage	$V_{CE(sat)}$	$V_{GE}=15V$ $I_C=10A$			3.5	V		
Input capacitance	C_{ies}	$V_{GE}=0V$		1200		pF		
Output capacitance	C_{oes}	$V_{CE}=10V$		250				
Reverse Transfer capacitance	C_{res}	$f=1\text{MHz}$		80				
Switching Time	Turn-on Time	t_{ON}	$V_{CC}=600V$			1.2	μs	
		t_r	$I_C=10A$			0.6		
	Turn-off Time	t_{OFF}	$V_{GE}=\pm 15V$			1.5		
		t_f	$R_G=160\Omega$			0.5		
	Turn-on Time	t_{ON}	$V_{CC}=600V$		0.16		μs	
		t_r	$I_C=10A$		0.11			
		Turn-off Time	t_{OFF}	$V_{GE}=+15V$		0.30		
			t_f	$R_G=16\Omega$				0.5

• Thermal Characteristics

Items	Symbols	Test Conditions	Min.	Typ.	Max.	Units
Thermal Resistance	$R_{th(j-c)}$				0.92	$^\circ\text{C/W}$

Collector Current vs. Collector-Emitter Voltage

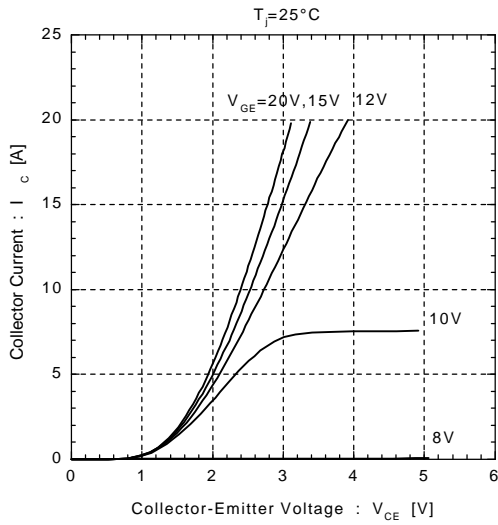

Collector Current vs. Collector-Emitter Voltage

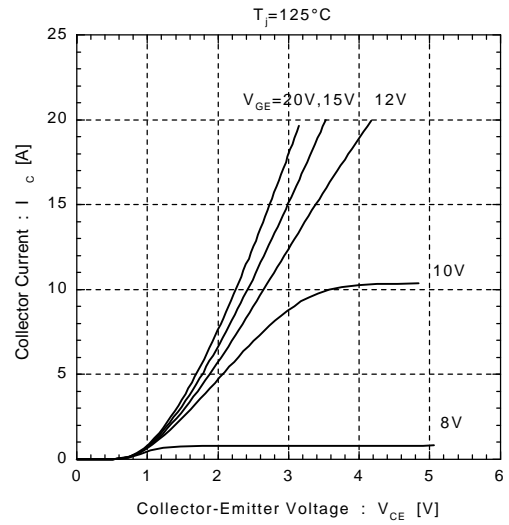

Collector-Emitter Voltage vs. Gate-Emitter Voltage

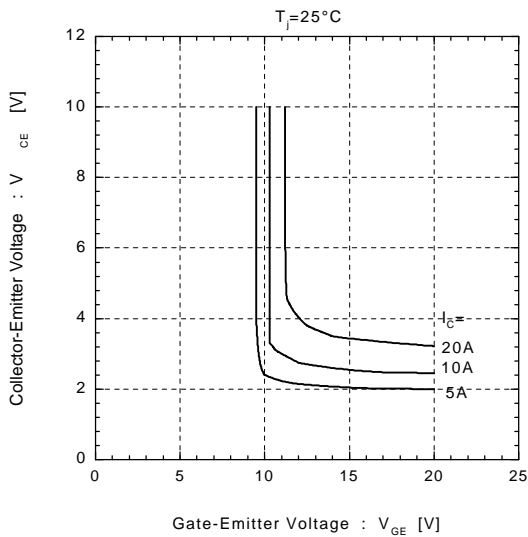

Collector-Emitter Voltage vs. Gate-Emitter Voltage

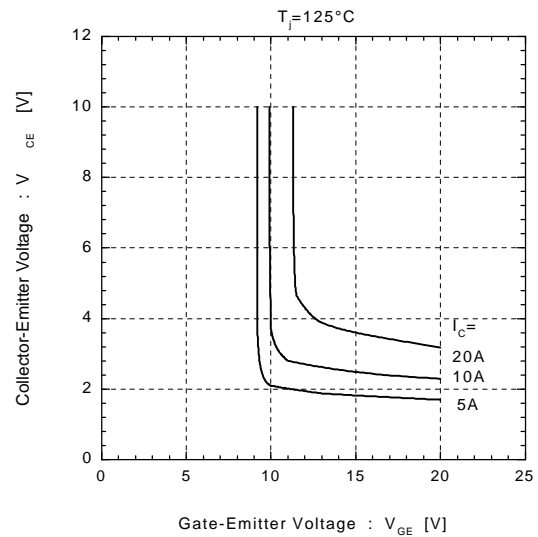

Switching Time vs. Collector Current

$V_{CC}=600V, R_G=16\Omega, V_{GE}=\pm 15V, T_J=25^\circ\text{C}$

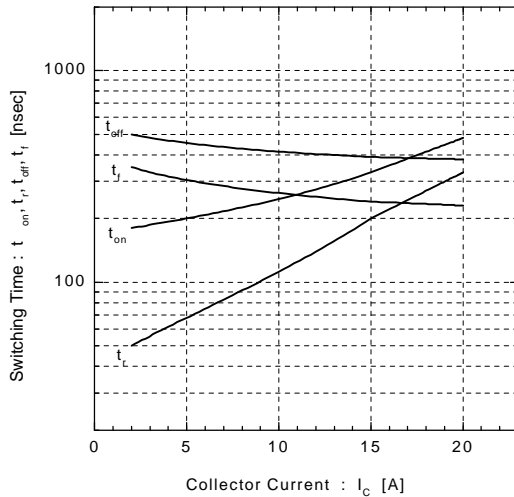

Switching Time vs. Collector Current

$V_{CC}=600V, R_G=16\Omega, V_{GE}=\pm 15V, T_J=125^\circ\text{C}$

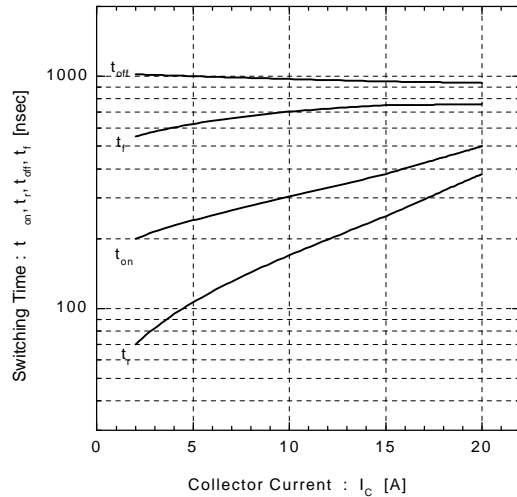

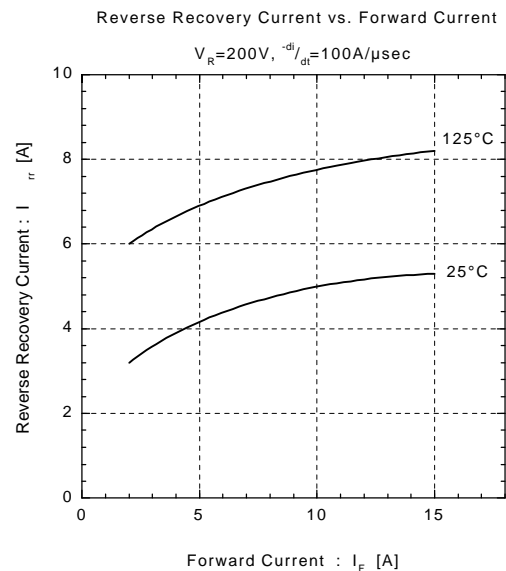
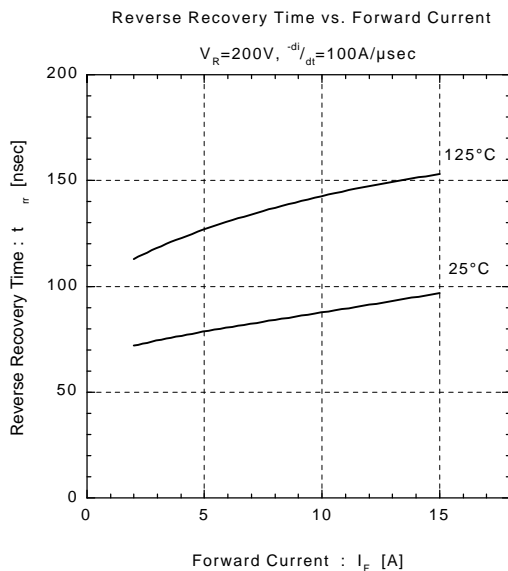
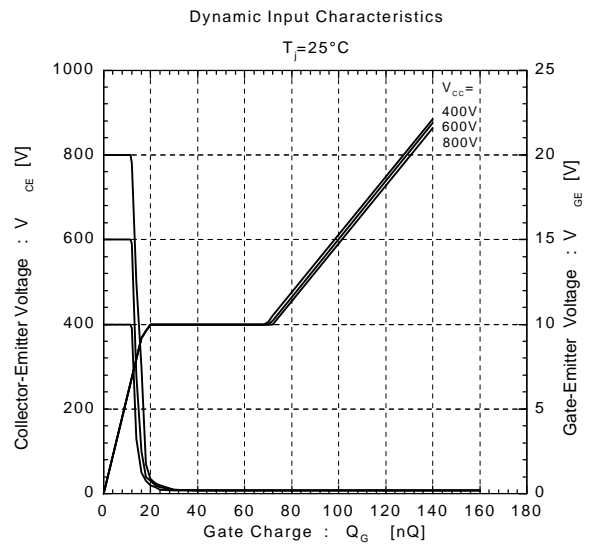
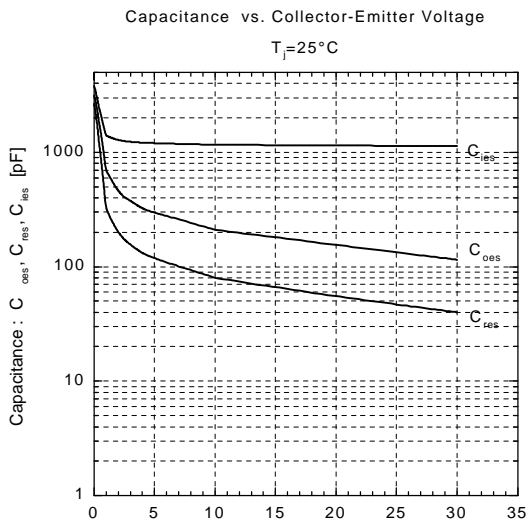
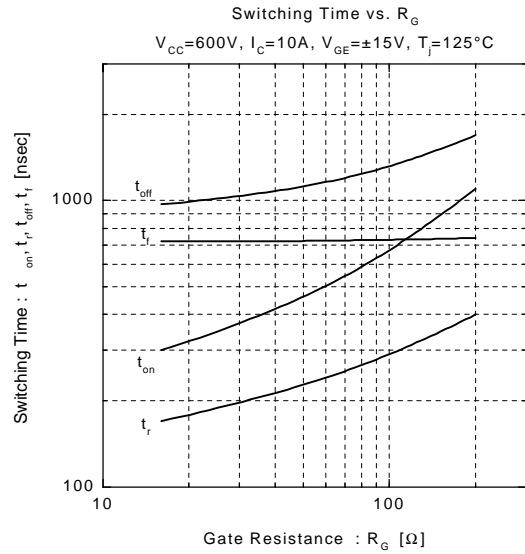
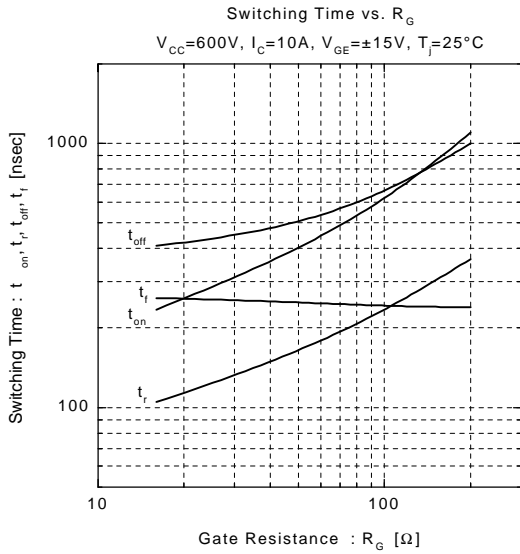

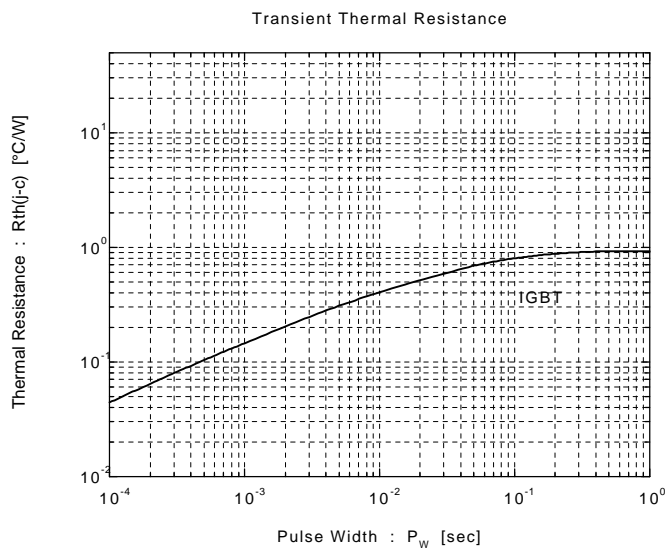
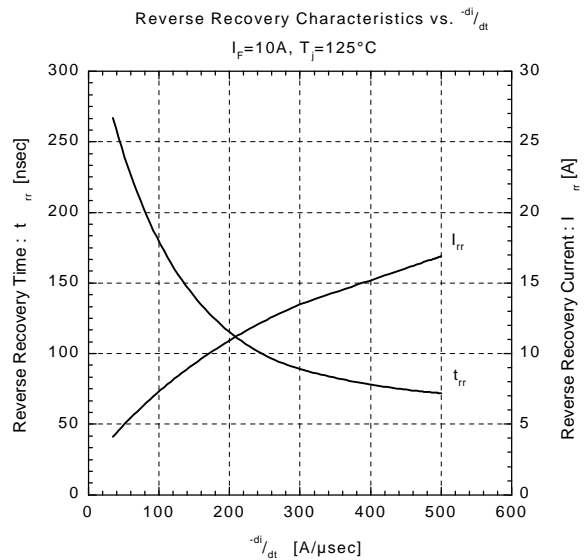
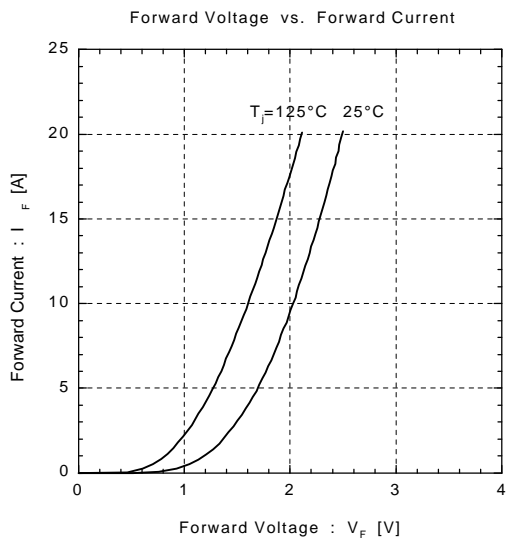
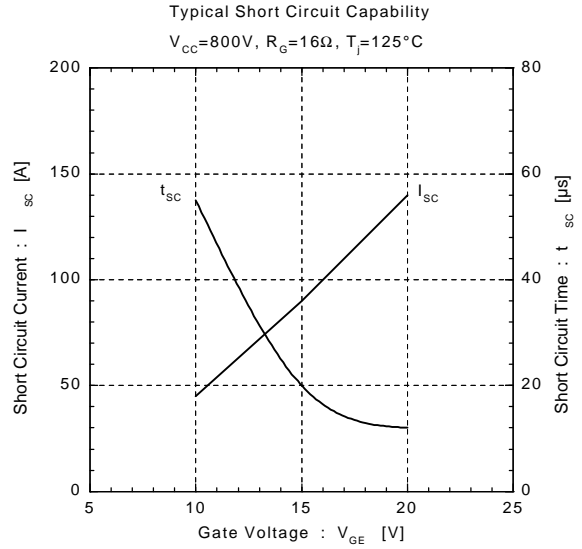
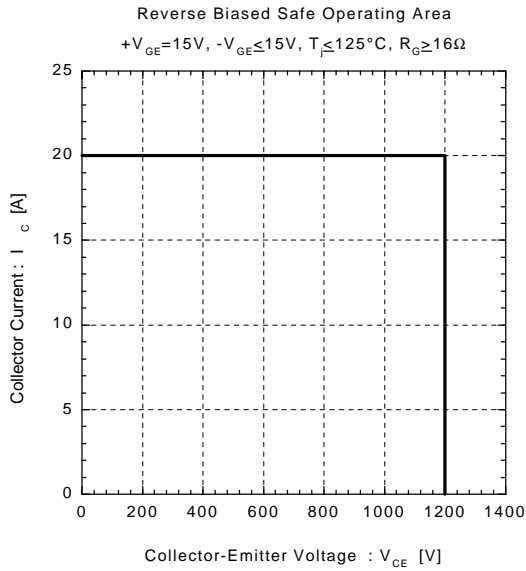

This datasheet has been download from:

www.datasheetcatalog.com

Datasheets for electronics components.